

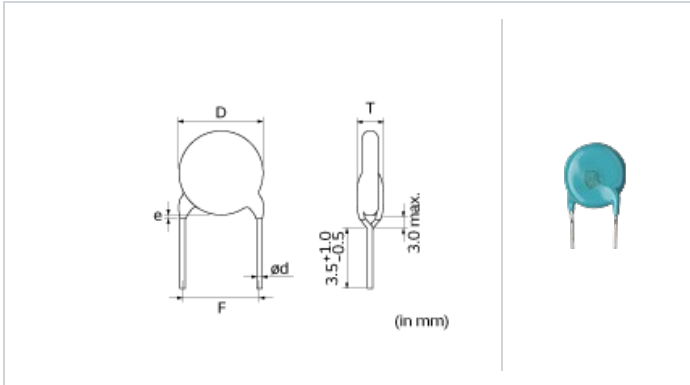

< List of part numbers with package codes >
DE1B3KX101KJ4BN01F

Shape



| | |
|---------------------------------|------------------------|
| L size or outer diameter D (mm) | 7.0 mm max. |
| T size | 7.0 mm max. |
| Lead spacing F | 10.0 ±0.8mm |
| Lead diameter d | 0.6 ±0.05mm |
| Paint dripping e | Up to the end of crimp |

Notes

X1/Y1 Class Certified Products, Halogen-free Products

References

| Packaging | Specifications | Minimum quantity |
|-----------|-----------------|------------------|
| B | Packing in bulk | 500 |

Specifications

| | |
|--|----------------|
| Capacitance | 100pF ±10% |
| Rated voltage | 250Vac(r.m.s.) |
| Temperature characteristics (complied standard) | B(JIS) |
| Capacitance change rate | ±10% |
| Temperature range of temperature characteristics | -25 to 85°C |
| Operating temperature range | -40 to 125°C |

Attention

- 1.This datasheet is downloaded from the website of Murata Manufacturing Co., Ltd. Therefore, it's specifications are subject to change or our products in it may be discontinued without advance notice. Please check with our sales representatives or product engineers before ordering.
- 2.This datasheet has only typical specifications because there is no space for detailed specifications. Therefore, please review our product specifications or consult the approval sheet for product specifications before ordering.

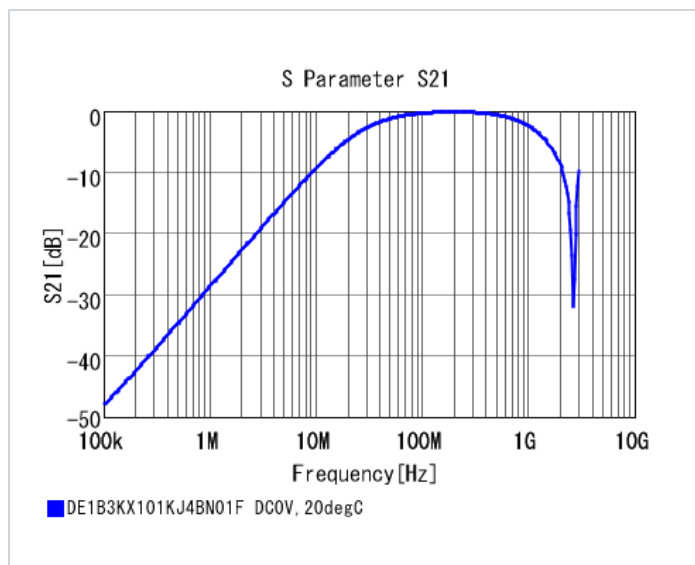
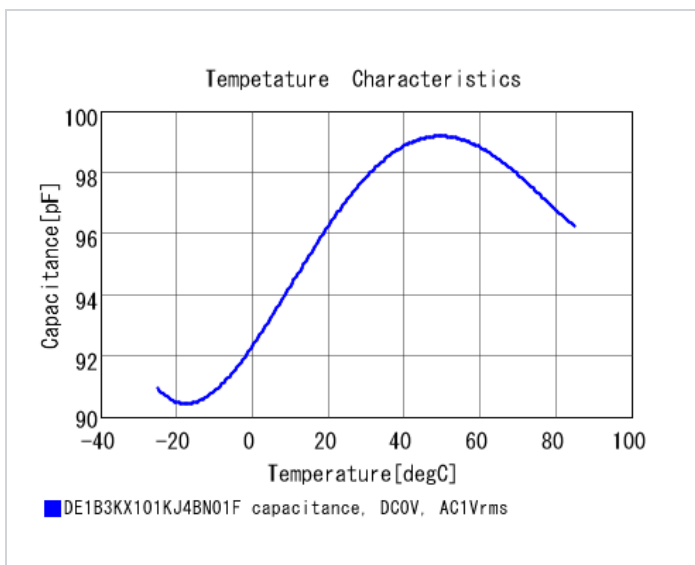
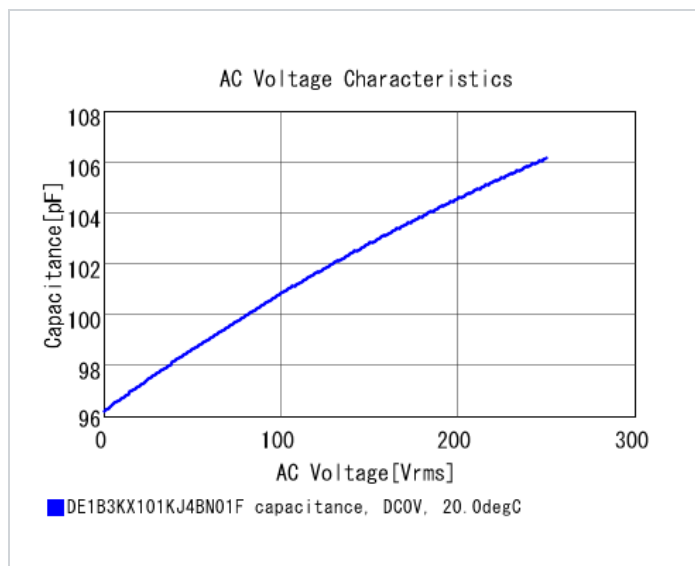
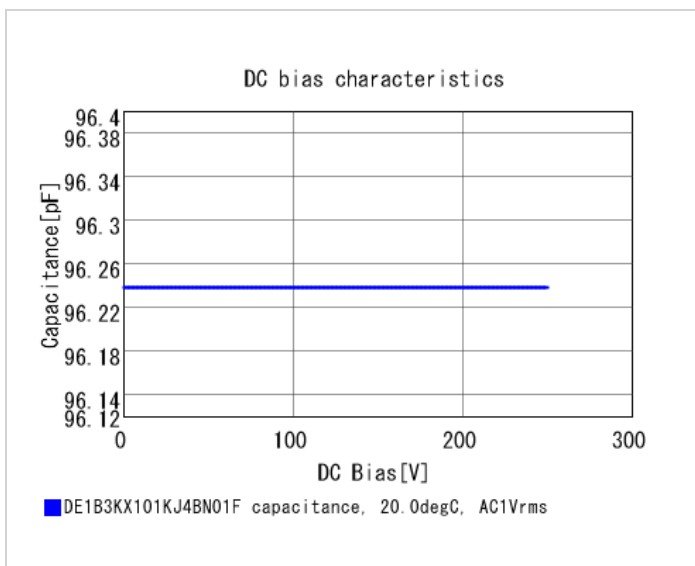
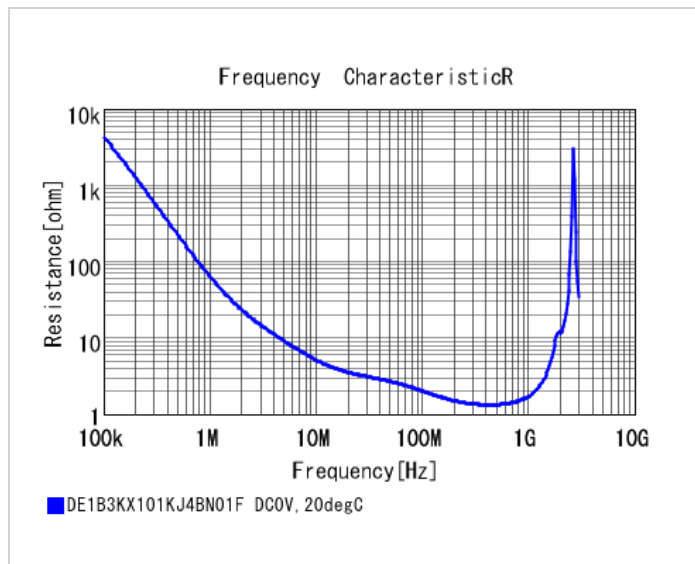
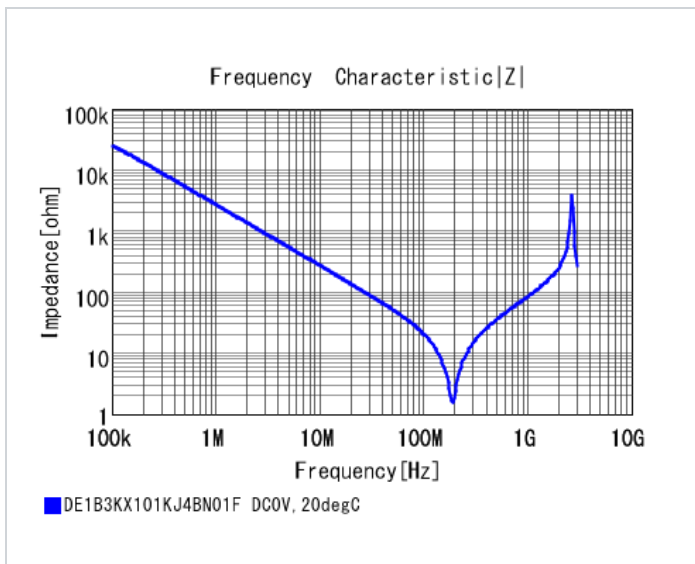

Attention

- 1.This datasheet is downloaded from the website of Murata Manufacturing Co., Ltd. Therefore, it's specifications are subject to change or our products in it may be discontinued without advance notice. Please check with our sales representatives or product engineers before ordering.
- 2.This datasheet has only typical specifications because there is no space for detailed specifications. Therefore, please review our product specifications or consult the approval sheet for product specifications before ordering.