

# R74, Single Metallized Polypropylene Film, Radial, AC Applications (Automotive Grade)

## Overview

The R74 Series is constructed of metallized polypropylene film with radial leads of tinned wire. The radial leads are electrically welded to the metal layer on the ends of the capacitor winding. The capacitor is encapsulated in a self-extinguishing solvent resistant plastic case with thermosetting resin material meeting the UL 94 V-0 requirements. Four different winding constructions are used depending on voltage parameters. Please see the Performance Characteristics for more information.

Automotive grade devices (up to lead spacing 22.5 mm) meet the demanding Automotive Electronics Council's AEC-Q200 qualification requirements.

## Applications

Typical applications include electronic lighting such as automotive headlamps and ballasts, as well as pulse applications with high AC voltage and high current. Not suitable for across-the-line application (see Suppressor Capacitors).

*ATTENTION -- This series was replaced by the R75 series. Please click on the link to the R75 series datasheet [HERE](#).*

## Benefits

- Voltage range: 250 – 900 VAC
- Capacitance range: 470 pF – 3.3  $\mu$ F
- Lead Spacing: 10 – 37.5 mm
- Capacitance tolerance:  $\pm$ 5%,  $\pm$ 10%
- Climatic category: 55/105/56 IEC 60068-1
- Operating temperature range of  $-55^{\circ}\text{C}$  to  $+105^{\circ}\text{C}$
- RoHS compliance and lead-free terminations
- Tape & Reel packaging in accordance with IEC 60286-2
- Self-healing
- Automotive (AEC-Q200) grades available up to lead spacing 22.5 mm

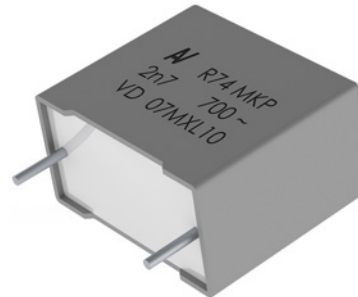

## Part Number System

R74	5	N	2180	AA	00	J
Series	Rated Voltage (VAC)	Lead Spacing (mm)	Capacitance Code (pF)	Packaging	Internal Use	Capacitance Tolerance
Metallized Polypropylene	L = 250 N = 400 5 = 500 6 = 600 7 = 700 9 = 900	F = 10 I = 15 N = 22.5 R = 27.5 W = 37.5	The last three digits represent significant figures. The first digit specifies the total number of zeros to be added.	See Ordering Options Table	00 30 60	J = $\pm$ 5% K = $\pm$ 10%

## Ordering Options Table

Lead Spacing Nominal (mm)	Type of Leads and Packaging	Lead Length (mm)	Lead and Packaging Code
10  15  22.5	<b>Standard Lead and Packaging Options</b>		
	Bulk (Bag) – Short Leads	4 +2/-0	AA
	Ammo Pack	H <sub>0</sub> = 18.5 ±0.5	DQ
	<b>Other Lead and Packaging Options</b>		
	Tape & Reel (Standard Reel Ø 355 mm)	H <sub>0</sub> = 18.5 ±0.5	GY
	Tape & Reel (Large Reel Ø 500 mm)	H <sub>0</sub> = 18.5 ±0.5	CK
	Bulk (Bag) – Short Leads	3.5 +0.5/-0	JB
	Bulk (Bag) – Short Leads	4.0 +0.5/-0	JE
	Bulk (Bag) – Short Leads	3.2 +0.3/-0.2	JH
	Bulk (Bag) – Long Leads	18±1	JM
Bulk (Bag) – Long Leads	30 +5/-0	40	
Bulk (Bag) – Long Leads	25 +2/-1	50	
27.5	<b>Standard Lead and Packaging Options</b>		
	Bulk (Tray) – Short Leads	4 +2/-0	AA
	<b>Other Lead and Packaging Options</b>		
	Tape & Reel (Standard Reel Ø 355 mm)	H <sub>0</sub> = 18.5 ±0.5	GY
	Tape & Reel (Large Reel Ø 500 mm)	H <sub>0</sub> = 18.5 ±0.5	CK <sup>1</sup>
	Bulk (Tray) – Short Leads	3.5 +0.5/-0	JB
	Bulk (Tray) – Short Leads	4.0 +0.5/-0	JE
	Bulk (Tray) – Short Leads	3.2 +0.3/-0.2	JH
	Bulk (Tray) – Long Leads	18±1	JM
	Bulk (Tray) – Long Leads	30 +5/-0	40
Bulk (Tray) – Long Leads	25 +2/-1	50	
37.5	<b>Standard Lead and Packaging Options</b>		
	Bulk (Tray) – Short Leads	4 +2/-0	AA
	<b>Other Lead and Packaging Options</b>		
	Bulk (Tray) – Short Leads	3.5 +0.5/-0	JB
	Bulk (Tray) – Short Leads	4.0 +0.5/-0	JE
	Bulk (Tray) – Short Leads	3.2 +0.3/-0.2	JH
	Bulk (Tray) – Long Leads	18 ±1	JM
	Bulk (Tray) – Long Leads	30 +5/-0	40
Bulk (Tray) – Long Leads	25 +2/-1	50	

<sup>1</sup> = Not for all sizes, see "Packaging Quantities" table.

## Dimensions – Millimeters

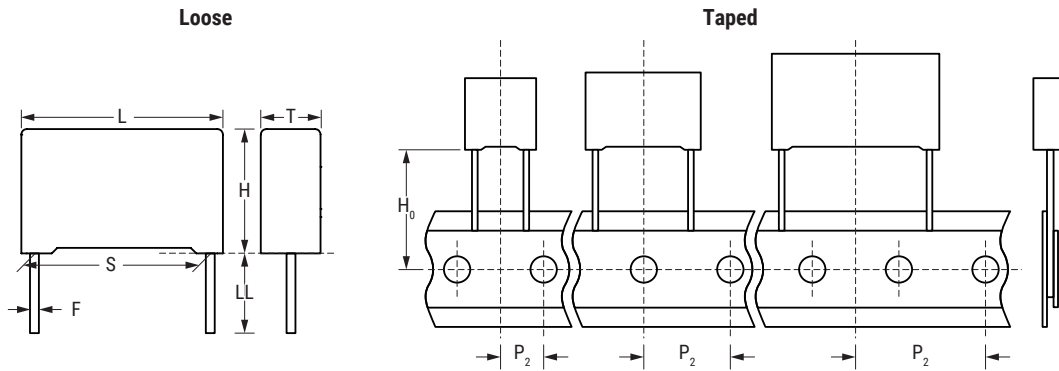

S		T		H		L		F	
Nominal	Tolerance	Nominal	Tolerance	Nominal	Tolerance	Nominal	Tolerance	Nominal	Tolerance
10.0	±0.4	4.0	+0.2/-0.5	9.0	+0.1/-0.5	13.0	+0.2/-0.5	0.6	±0.05
10.0	±0.4	5.0	+0.2/-0.5	11.0	+0.1/-0.5	13.0	+0.2/-0.5	0.6	±0.05
10.0	±0.4	6.0	+0.2/-0.5	12.0	+0.1/-0.5	13.0	+0.2/-0.5	0.6	±0.05
15.0	±0.4	4.0	+0.2/-0.5	10.0	+0.1/-0.5	18.0	+0.3/-0.5	0.8	±0.05
15.0	±0.4	5.0	+0.2/-0.5	11.0	+0.1/-0.5	18.0	+0.3/-0.5	0.8	±0.05
15.0	±0.4	6.0	+0.2/-0.5	12.0	+0.1/-0.5	18.0	+0.3/-0.5	0.8	±0.05
15.0	±0.4	7.5	+0.2/-0.5	13.5	+0.1/-0.5	18.0	+0.5/-0.5	0.8	±0.05
15.0	±0.4	8.5	+0.2/-0.5	14.5	+0.1/-0.5	18.0	+0.5/-0.5	0.8	±0.05
15.0	±0.4	9.0	+0.2/-0.5	12.5	+0.1/-0.5	18.0	+0.5/-0.5	0.8	±0.05
15.0	±0.4	10.0	+0.2/-0.5	16.0	+0.1/-0.5	18.0	+0.5/-0.5	0.8	±0.05
15.0	±0.4	11.0	+0.2/-0.5	19.0	+0.1/-0.5	18.0	+0.5/-0.5	0.8	±0.05
15.0	±0.4	13.0	+0.2/-0.5	12.0	+0.1/-0.5	18.0	+0.5/-0.5	0.8	±0.05
22.5	±0.4	6.0	+0.2/-0.5	15.0	+0.1/-0.5	26.5	+0.3/-0.5	0.8	±0.05
22.5	±0.4	7.0	+0.2/-0.5	16.0	+0.1/-0.5	26.5	+0.3/-0.5	0.8	±0.05
22.5	±0.4	8.5	+0.2/-0.5	17.0	+0.1/-0.5	26.5	+0.3/-0.5	0.8	±0.05
22.5	±0.4	10.0	+0.2/-0.5	18.5	+0.1/-0.5	26.5	+0.3/-0.5	0.8	±0.05
22.5	±0.4	11.0	+0.2/-0.5	20.0	+0.1/-0.5	26.5	+0.3/-0.5	0.8	±0.05
22.5	±0.4	13.0	+0.2/-0.5	22.0	+0.1/-0.5	26.5	+0.3/-0.5	0.8	±0.05

Note: See Ordering Options Table for lead length (LL/Ho) options.

## Dimensions – Millimeters cont.



S		T		H		L		F	
Nominal	Tolerance	Nominal	Tolerance	Nominal	Tolerance	Nominal	Tolerance	Nominal	Tolerance
27.5	±0.4	9.0	+0.2/-0.7	17.0	+0.1/-0.7	32.0	+0.3/-0.7	0.8	±0.05
27.5	±0.4	11.0	+0.2/-0.7	20.0	+0.1/-0.7	32.0	+0.3/-0.7	0.8	±0.05
27.5	±0.4	13.0	+0.2/-0.7	22.0	+0.1/-0.7	32.0	+0.3/-0.7	0.8	±0.05
27.5	±0.4	13.0	+0.2/-0.7	25.0	+0.1/-0.7	32.0	+0.3/-0.7	0.8	±0.05
27.5	±0.4	14.0	+0.2/-0.7	28.0	+0.1/-0.7	32.0	+0.3/-0.7	0.8	±0.05
27.5	±0.4	18.0	+0.2/-0.7	33.0	+0.1/-0.7	32.0	+0.3/-0.7	0.8	±0.05
27.5	±0.4	22.0	+0.2/-0.7	37.0	+0.1/-0.7	32.0	+0.3/-0.7	0.8	±0.05
27.5	±0.4	24.0	+0.2/-0.7	15.0	+0.1/-0.7	32.0	+0.3/-0.7	0.8	±0.05
37.5	±0.4	11.0	+0.3/-0.7	22.0	+0.1/-0.7	41.5	+0.3/-0.7	1.0	±0.05
37.5	±0.4	13.0	+0.3/-0.7	24.0	+0.1/-0.7	41.5	+0.3/-0.7	1.0	±0.05
37.5	±0.4	16.0	+0.3/-0.7	28.5	+0.1/-0.7	41.5	+0.3/-0.7	1.0	±0.05
37.5	±0.4	19.0	+0.3/-0.7	32.0	+0.1/-0.7	41.5	+0.3/-0.7	1.0	±0.05
37.5	±0.4	20.0	+0.3/-0.7	40.0	+0.1/-0.7	41.5	+0.3/-0.7	1.0	±0.05
37.5	±0.4	24.0	+0.3/-0.7	44.0	+0.1/-0.7	41.5	+0.3/-0.7	1.0	±0.05
37.5	±0.4	24.0	+0.3/-0.7	15.0	+0.1/-0.7	41.5	+0.3/-0.7	1.0	±0.05
37.5	±0.4	24.0	+0.3/-0.7	19.0	+0.1/-0.7	41.5	+0.3/-0.7	1.0	±0.05
37.5	±0.4	30.0	+0.3/-0.7	45.0	+0.1/-0.7	41.5	+0.3/-0.7	1.0	±0.05

**Note: See Ordering Options Table for lead length (LL/Ho) options.**

## Performance Characteristics

Dielectric	Polypropylene film					
Plates	Metal layer deposited by evaporation under vacuum					
Winding	Non-inductive type					
Leads	Tinned wire					
Protection	Plastic case, thermosetting resin filled. Box material is solvent resistant and flame retardant according to UL94.					
Related Documents	IEC 60384-16, IEC 60384-17					
Sections	1	2		3		4
Rated Voltage $V_R$ (VDC)	630	1300	1600	2000	2000	2200
Rated Voltage $V_R$ (VAC)	250	400	500	600	700	900
Capacitance Range ( $\mu\text{F}$ )	0.01 – 0.15	0.0022 – 3.3	0.001 – 2.2	0.00047 – 1	0.001 – 0.47	0.001 – 0.47
Capacitance Values	E12 series (IEC 60063) measured at 1kHz and +20 $\pm$ 1°C					
Capacitance Tolerance	$\pm$ 5%, $\pm$ 10%					
Operating Temperature Range	-55°C to +105°C					
Rated Temperature $T_R$	+85°C					
Voltage Derating	Above +85°C DC and AC voltage derating is 1.25%/°C					
Climatic Category	55/105/56 IEC 60068-1					
Storage Conditions	Storage time: $\leq$ 24 months from the date marked on the package label					
	Average relative humidity per year $\leq$ 70%					
	RH $\leq$ 85% for 30 days randomly distributed throughout the year					
	Dew is absent					
	Temperature: -40 to 80°C (see "Maximum Humidity in Storage Conditions" graph below)					
Test Voltage	1.6 x $V_R$ VDC for 2 seconds (between terminations) at +25°C $\pm$ 5°C					
Capacitance Drift	Maximum 0.5% after a 2 year storage period at a temperature of +10°C to +40°C and a relative humidity of 40% to 60%					
Maximum Pulse Steepness	dV/dt according to Table 1. For working voltages lower than rated voltage ( $V < V_R$ ), the specified dV/dt can be multiplied by the factor $V_R/V$ .					
Temperature Coefficient	-(200 $\pm$ 100) ppm/°C at 1 kHz					
Self Inductance (Lead Length ~ 2 mm)	Lead Spacing (mm)	10	15	22.5	27.5	37.5
	L (nH) $\approx$	9	10	16	18	20
	Maximum 1 nH per 1 mm lead and capacitor length.					
Dissipation Factor $\tan\delta$	Maximum Values at 25°C $\pm$ 5°C					
	Frequency	$C \leq 2.2$ nF	$2.2$ nF $< C \leq 0.027$ $\mu\text{F}$	$0.027$ $\mu\text{F} < C \leq 0.1$ $\mu\text{F}$	$0.1$ $\mu\text{F} < C \leq 1$ $\mu\text{F}$	$C > 1$ $\mu\text{F}$
	1 kHz	0.01%	0.01%	0.04%	0.05%	0.06%
	10 kHz	0.02%	0.02%	0.06%	0.08%	-
	100 kHz	0.03%	0.08%	0.25%	-	-

## Performance Characteristics cont.

Insulation Resistance	Measured at +25°C ±5°C, 100 VDC 60 seconds	
	Minimum Values Between Terminals	
	C ≤ 0.33 μF	C > 0.33 μF
	≥ 100,000 MΩ	≥ 30,000 MΩ · μF

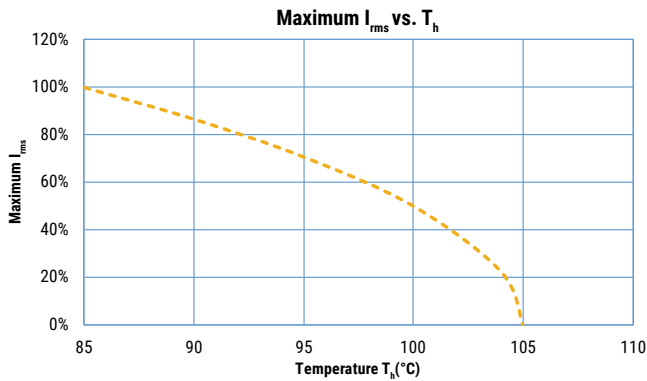
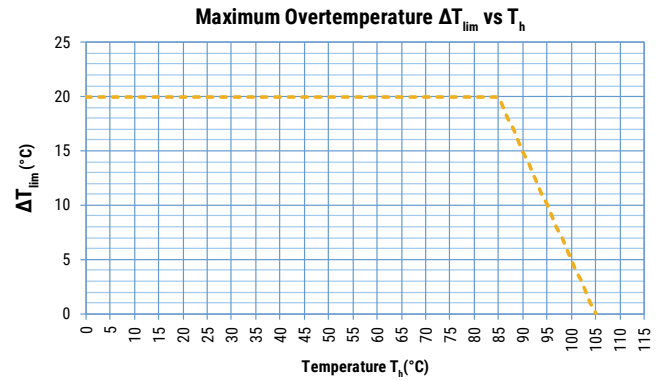
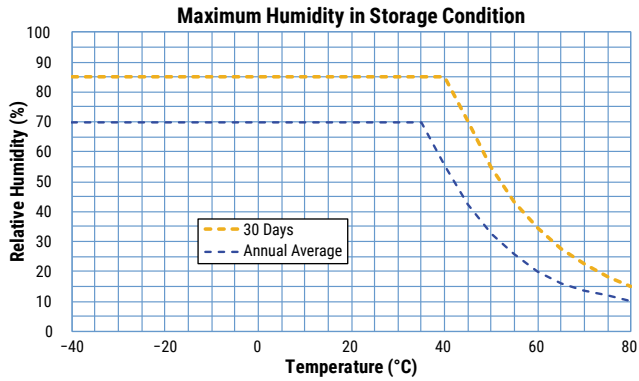

$T_h$  is the maximum ambient temperature surrounding the capacitor or hottest contact point (e.g. tracks), whichever is higher, in the worst operation conditions in °C.

## Qualification

Automotive Grade products meet or exceed the requirements outlined by the Automotive Electronics Council. Details regarding test methods and conditions are referenced in document AEC-Q200, Stress Test Qualification for Passive Components. For additional information regarding the Automotive Electronics Council and AEC-Q200, please visit their website at [www.aecouncil.com](http://www.aecouncil.com).

## Maximum Voltage ( $V_{rms}$ ) vs. Frequency (Sinusoidal Waveform/ $Th \leq 85^\circ C$ )

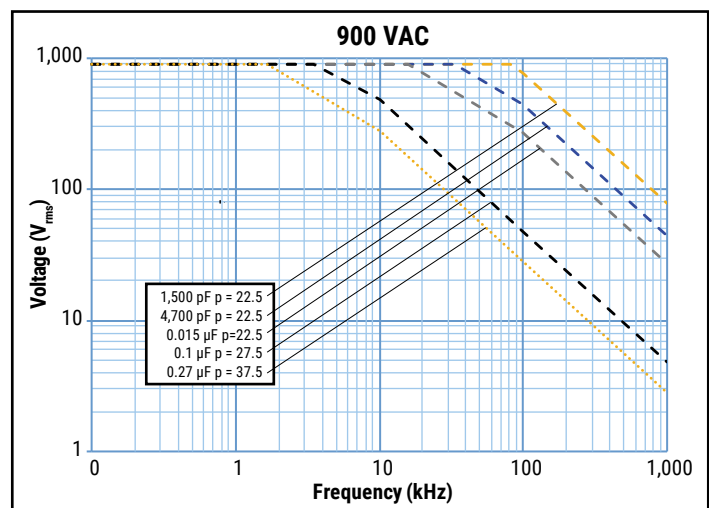
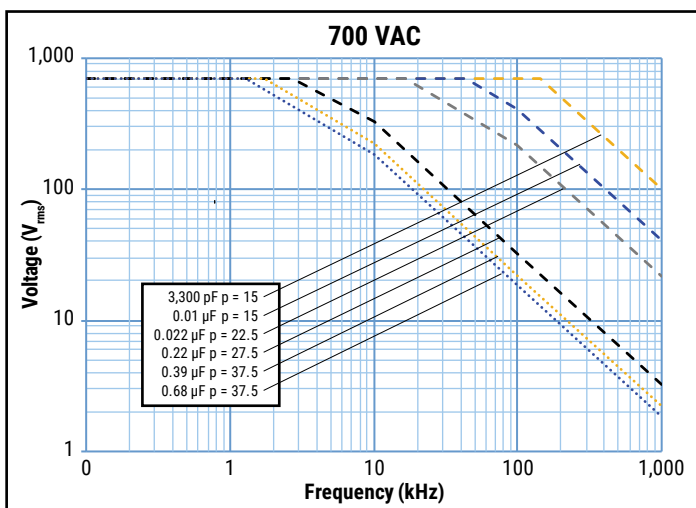
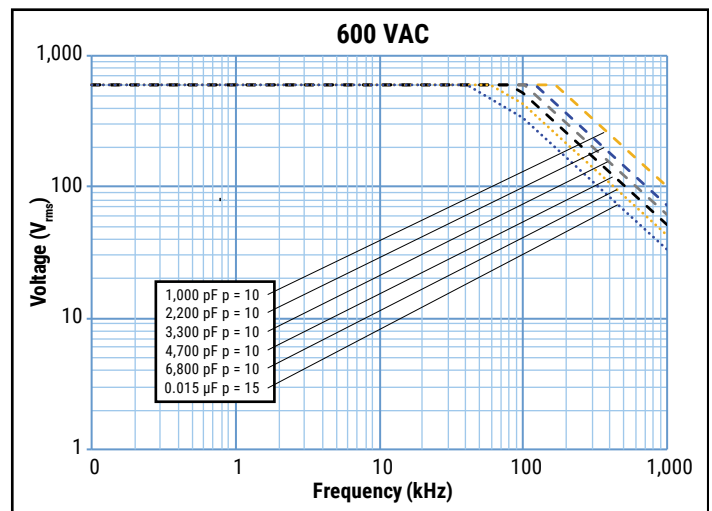
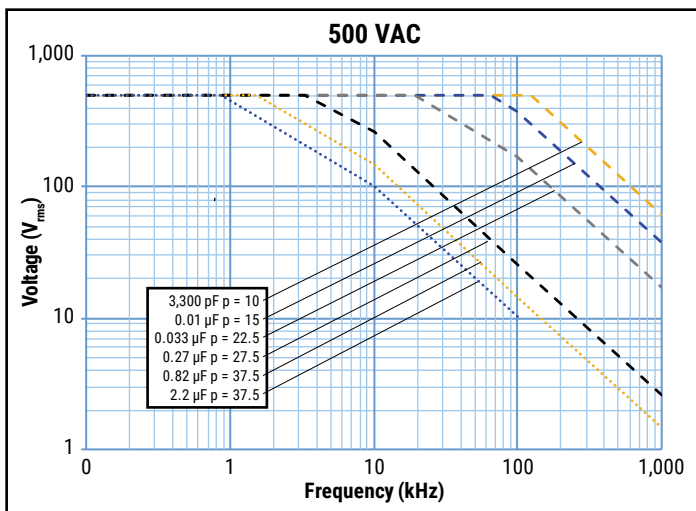
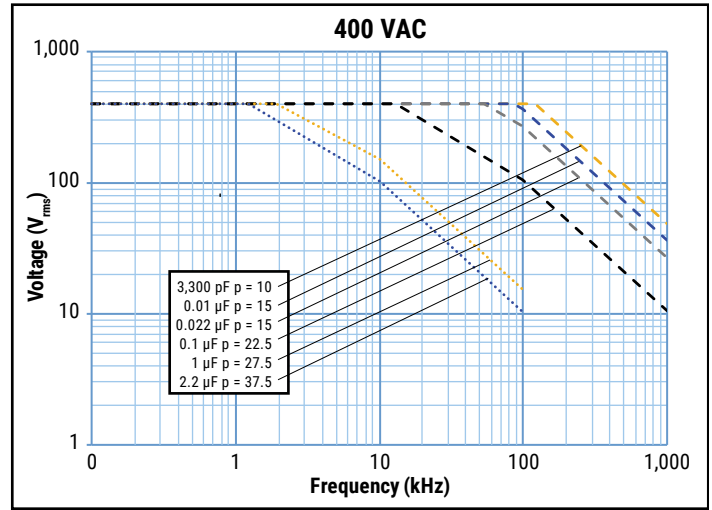
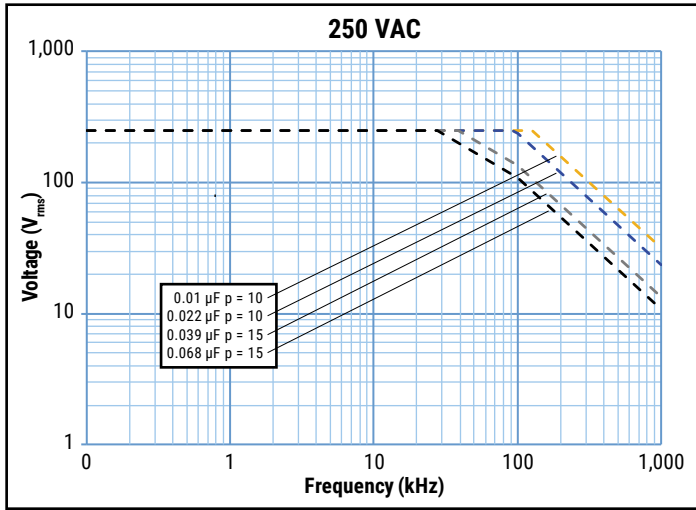

## Maximum Current ( $I_{rms}$ ) vs. Frequency (Sinusoidal Waveform/ $T_h \leq 85^\circ\text{C}$ )

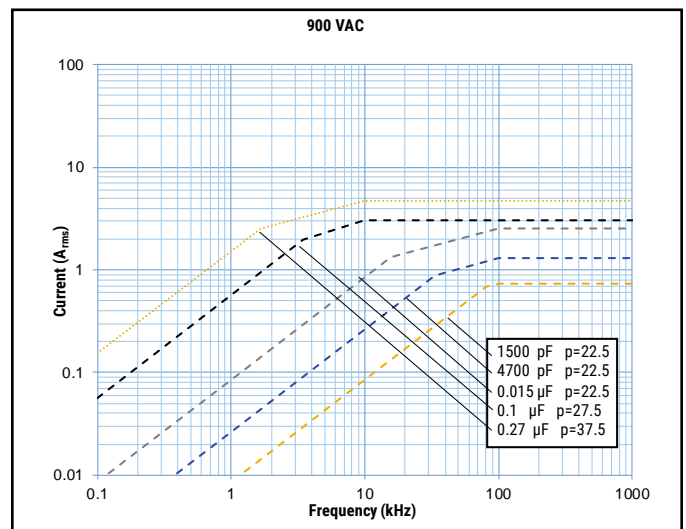
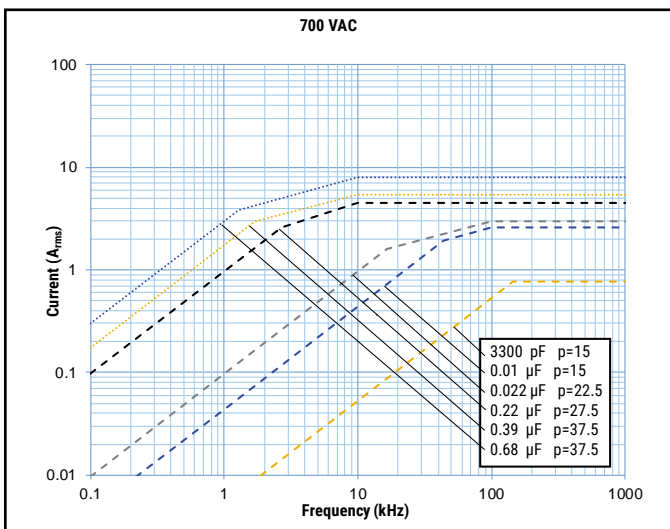
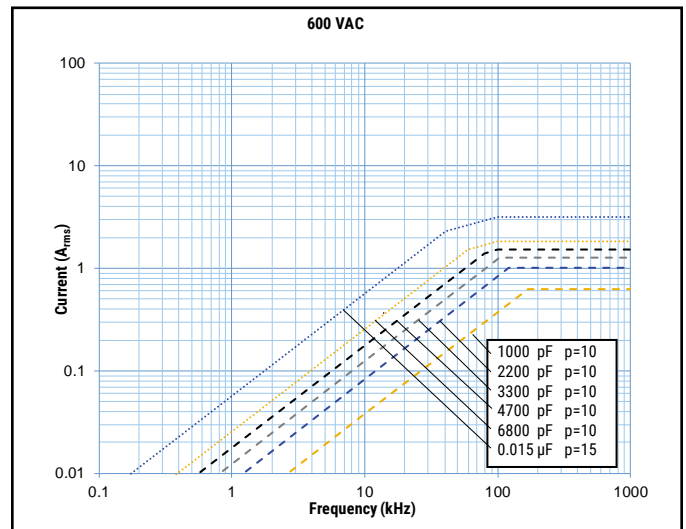
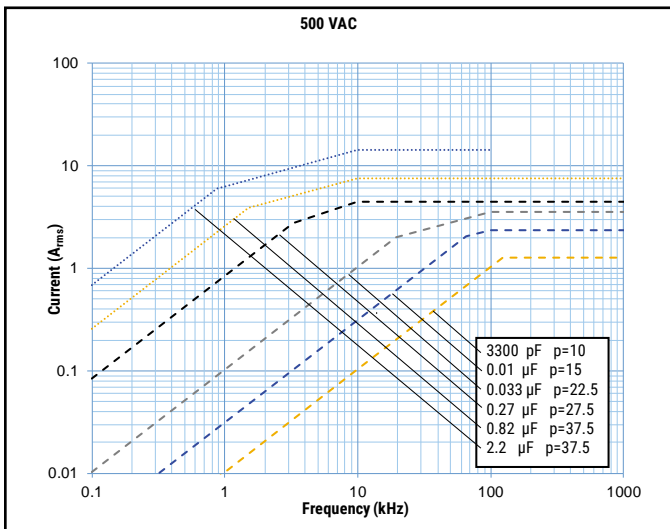
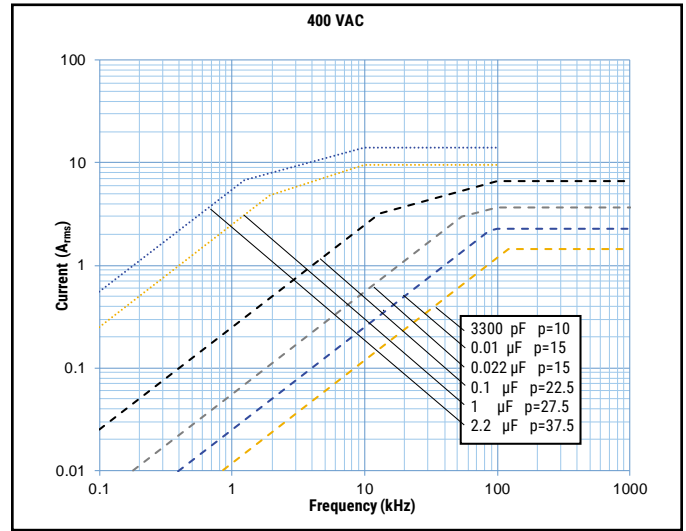
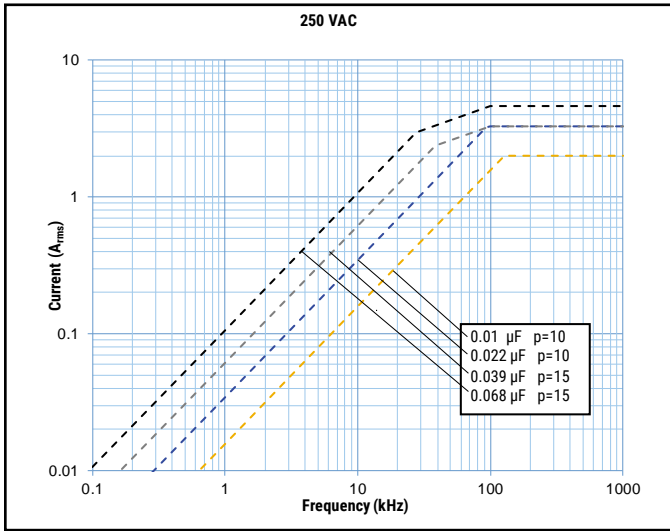



## Environmental Test Data

Damp Heat, Steady State Test	Test Conditions:		Performances
	Temperature:	+40°C ± 2°C	Δ C/C  ≤ 2%, Δ tanδ ≤ 0.001 at 1 kHz IR after test ≥ 50% of initial limit
	Relative humidity (RH):	93% ± 2%	
	Test duration:	56 days	
Endurance Test	Test Conditions		Performances
	Temperature:	+85°C ± 2°C	Δ C/C  ≤ 5%, Δ tanδ ≤ 0.0015 at 1 kHz IR after test ≥ 50% of initial limit
	Voltage applied:	1.25 x V <sub>R</sub> (AC) at 50 Hz	
	Test duration:	2,000 hours	
Resistance to Soldering Heat Test	Test Conditions		Performances
	Solder bath temperature:	260°C ± 5°C	Δ C/C  ≤ 1%, Δ tanδ ≤ 0.001 at 1 kHz IR after test ≥ initial limit
	Dipping time (with heat screen):	10 seconds ± 1 second	

## Environmental Compliance

All KEMET pulse capacitors are RoHS Compliant.



**Table 1 – Ratings & Part Number Reference**

VAC	VDC	Cap Value (µF)	Dimensions in mm			Lead Spacing (S)	dV/dt (V/µs)	Max K <sub>0</sub> (V <sup>2</sup> /µs)	I <sub>pk</sub>	ESL	ESR max	I <sub>rms</sub> max (*)	R <sub>th</sub>	KEMET Internal Part Number	Customer Part Number
										Lead Length 2x 4 mm	at 100 kHz	at 100 kHz, 85°C			
			T	H	L				A <sub>pk</sub>	nH	mΩ	A <sub>rms</sub>	(°C/W)		
250	630	0.010	4.0	9.0	13.0	10.0	300	378,000	3	9	64	1.6	79	74LF2100(1)00(2)	R74LF2100(1)00(2)
250	630	0.012	4.0	9.0	13.0	10.0	300	378,000	4	9	53	1.9	79	74LF2120(1)00(2)	R74LF2120(1)00(2)
250	630	0.015	5.0	11.0	13.0	10.0	300	378,000	5	9	42	2.4	69	74LF2150(1)00(2)	R74LF2150(1)00(2)
250	630	0.018	5.0	11.0	13.0	10.0	300	378,000	5	9	35	2.8	69	74LF2180(1)00(2)	R74LF2180(1)00(2)
250	630	0.022	6.0	12.0	13.0	10.0	300	378,000	7	9	29	3.3	64	74LF2220(1)00(2)	R74LF2220(1)00(2)
250	630	0.027	6.0	12.0	13.0	10.0	300	378,000	8	9	24	3.6	64	74LF2270(1)00(2)	R74LF2270(1)00(2)
250	630	0.015	5.0	11.0	18.0	15.0	250	315,000	4	10	42	2.4	60	74LI2150(1)00(2)	R74LI2150(1)00(2)
250	630	0.018	5.0	11.0	18.0	15.0	250	315,000	5	10	35	2.8	60	74LI2180(1)00(2)	R74LI2180(1)00(2)
250	630	0.022	5.0	11.0	18.0	15.0	250	315,000	6	10	29	3.4	60	74LI2220(1)00(2)	R74LI2220(1)00(2)
250	630	0.027	5.0	11.0	18.0	15.0	250	315,000	7	10	24	3.8	60	74LI2270(1)00(2)	R74LI2270(1)00(2)
250	630	0.033	5.0	11.0	18.0	15.0	250	315,000	8	10	39	2.9	60	74LI2330(1)00(2)	R74LI2330(1)00(2)
250	630	0.039	6.0	12.0	18.0	15.0	250	315,000	10	10	33	3.3	56	74LI2390(1)00(2)	R74LI2390(1)00(2)
250	630	0.047	6.0	12.0	18.0	15.0	250	315,000	12	10	27	3.6	56	74LI2470(1)00(2)	R74LI2470(1)00(2)
250	630	0.056	7.5	13.5	18.0	15.0	250	315,000	14	10	23	4.2	51	74LI2560(1)00(2)	R74LI2560(1)00(2)
250	630	0.068	7.5	13.5	18.0	15.0	250	315,000	17	10	23	4.1	51	74LI2680(1)00(2)	R74LI2680(1)00(2)
250	630	0.068	9.0	12.5	18.0	15.0	250	315,000	17	10	23	4.2	50	74LI2680(1)60(2)	R74LI2680(1)60(2)
250	630	0.082	8.5	14.5	18.0	15.0	250	315,000	21	10	19	4.6	48	74LI2820(1)00(2)	R74LI2820(1)00(2)
250	630	0.082	13.0	12.0	18.0	15.0	250	315,000	21	10	19	4.8	45	74LI2820(1)60(2)	R74LI2820(1)60(2)
250	630	0.10	8.5	14.5	18.0	15.0	250	315,000	25	10	16	5.1	48	74LI3100(1)00(2)	R74LI3100(1)00(2)
250	630	0.10	13.0	12.0	18.0	15.0	250	315,000	25	10	16	5.3	45	74LI3100(1)60(2)	R74LI3100(1)60(2)
250	630	0.12	10.0	16.0	18.0	15.0	250	315,000	30	10	13	5.8	44	74LI3120(1)00(2)	R74LI3120(1)00(2)
250	630	0.15	11.0	19.0	18.0	15.0	250	315,000	38	10	11	6.8	40	74LI3150(1)00(2)	R74LI3150(1)00(2)
400	1,300	0.0022	4.0	9.0	13.0	10.0	2,200	5,720,000	5	9	289	0.6	79	74NF1220(1)00(2)	R74NF1220(1)00(2)
400	1,300	0.0027	4.0	9.0	13.0	10.0	2,200	5,720,000	6	9	236	0.7	79	74NF1270(1)00(2)	R74NF1270(1)00(2)
400	1,300	0.0033	4.0	9.0	13.0	10.0	2,200	5,720,000	7	9	193	0.8	79	74NF1330(1)00(2)	R74NF1330(1)00(2)
400	1,300	0.0039	5.0	11.0	13.0	10.0	2,200	5,720,000	9	9	163	1.0	69	74NF1390(1)00(2)	R74NF1390(1)00(2)
400	1,300	0.0047	5.0	11.0	13.0	10.0	2,200	5,720,000	10	9	135	1.2	69	74NF1470(1)00(2)	R74NF1470(1)00(2)
400	1,300	0.0056	5.0	11.0	13.0	10.0	2,200	5,720,000	12	9	114	1.4	69	74NF1560(1)00(2)	R74NF1560(1)00(2)
400	1,300	0.0068	6.0	12.0	13.0	10.0	2,200	5,720,000	15	9	94	1.7	64	74NF1680(1)00(2)	R74NF1680(1)00(2)
400	1,300	0.0082	6.0	12.0	13.0	10.0	2,200	5,720,000	18	9	78	2.0	64	74NF1820(1)00(2)	R74NF1820(1)00(2)
400	1,300	0.0068	5.0	11.0	18.0	15.0	2,000	5,200,000	14	10	94	1.7	60	74NI1680(1)00(2)	R74NI1680(1)00(2)
400	1,300	0.0082	5.0	11.0	18.0	15.0	2,000	5,200,000	16	10	78	2.1	60	74NI1820(1)00(2)	R74NI1820(1)00(2)
400	1,300	0.010	5.0	11.0	18.0	15.0	2,000	5,200,000	20	10	64	2.3	60	74NI2100(1)00(2)	R74NI2100(1)00(2)
400	1,300	0.012	6.0	12.0	18.0	15.0	2,000	5,200,000	24	10	53	2.6	56	74NI2120(1)00(2)	R74NI2120(1)00(2)
400	1,300	0.015	6.0	12.0	18.0	15.0	2,000	5,200,000	30	10	42	2.9	56	74NI2150(1)00(2)	R74NI2150(1)00(2)
400	1,300	0.018	7.5	13.5	18.0	15.0	2,000	5,200,000	36	10	35	3.3	51	74NI2180(1)00(2)	R74NI2180(1)00(2)
400	1,300	0.022	7.5	13.5	18.0	15.0	2,000	5,200,000	44	10	29	3.7	51	74NI2220(1)00(2)	R74NI2220(1)00(2)
400	1,300	0.022	9.0	12.5	18.0	15.0	2,000	5,200,000	44	10	29	3.7	50	74NI2220(1)60(2)	R74NI2220(1)60(2)
400	1,300	0.027	8.5	14.5	18.0	15.0	2,000	5,200,000	54	10	24	4.2	48	74NI2270(1)00(2)	R74NI2270(1)00(2)
400	1,300	0.027	13.0	12.0	18.0	15.0	2,000	5,200,000	54	10	24	4.3	45	74NI2270(1)60(2)	R74NI2270(1)60(2)
400	1,300	0.033	8.5	14.5	18.0	15.0	2,000	5,200,000	66	10	24	4.2	48	74NI2330(1)00(2)	R74NI2330(1)00(2)
400	1,300	0.033	13.0	12.0	18.0	15.0	2,000	5,200,000	66	10	24	4.3	45	74NI2330(1)60(2)	R74NI2330(1)60(2)
400	1,300	0.039	10.0	16.0	18.0	15.0	2,000	5,200,000	78	10	20	4.7	44	74NI2390(1)00(2)	R74NI2390(1)00(2)
400	1,300	0.039	13.0	12.0	18.0	15.0	2,000	5,200,000	78	10	20	4.7	45	74NI2390(1)60(2)	R74NI2390(1)60(2)
400	1,300	0.047	10.0	16.0	18.0	15.0	2,000	5,200,000	94	10	17	5.2	44	74NI2470(1)00(2)	R74NI2470(1)00(2)
400	1,300	0.056	11.0	19.0	18.0	15.0	2,000	5,200,000	112	10	14	5.9	40	74NI2560(1)00(2)	R74NI2560(1)00(2)
400	1,300	0.039	6.0	15.0	26.5	22.5	800	2,080,000	31	16	20	4.8	43	74NN2390(1)00(2)	R74NN2390(1)00(2)
400	1,300	0.047	7.0	16.0	26.5	22.5	800	2,080,000	38	16	17	5.4	41	74NN2470(1)00(2)	R74NN2470(1)00(2)
400	1,300	0.056	7.0	16.0	26.5	22.5	800	2,080,000	45	16	14	5.9	41	74NN2560(1)00(2)	R74NN2560(1)00(2)
400	1,300	0.068	8.5	17.0	26.5	22.5	800	2,080,000	54	16	19	5.3	38	74NN2680(1)00(2)	R74NN2680(1)00(2)
400	1,300	0.082	10.0	18.5	26.5	22.5	800	2,080,000	66	16	16	6.0	36	74NN2820(1)00(2)	R74NN2820(1)00(2)
400	1,300	0.10	10.0	18.5	26.5	22.5	800	2,080,000	80	16	13	6.6	36	74NN3100(1)00(2)	R74NN3100(1)00(2)
VAC	VDC	Cap Value	T	H	L	Lead Spacing (S)	dV/dt (V/µs)	Max K <sub>0</sub> (V <sup>2</sup> /µs)	A <sub>pk</sub>	nH	mΩ	A <sub>rms</sub>	(°C/W)	KEMET Internal Part Number	Customer Part Number
									I <sub>pk</sub>	ESL	ESR	I <sub>rms</sub> max (*)	R <sub>th</sub>		

(1) Insert lead and packaging code. See Ordering Options Table for available options.

(2) J = 5%, K = ±10%

(\*) I<sub>rms</sub> value that leads to a ΔT of ≈ 20°C in the hot spot > T<sub>HS</sub> = T<sub>AMB</sub> + ΔT = 85°C + 20°C = 105°C

**Table 1 – Ratings & Part Number Reference cont.**

VAC	VDC	Cap Value (µF)	Dimensions in mm			Lead Spacing (S)	dV/dt (V/µs)	Max K <sub>0</sub> (V <sup>2</sup> /µs)	I <sub>pk</sub>	ESL	ESR max	I <sub>rms</sub> max (*)	R <sub>th</sub>	KEMET Internal Part Number	Customer Part Number
										Lead Length 2x 4 mm	at 100 kHz	at 100 kHz, 85°C			
			A <sub>pk</sub>	nH	mΩ				A <sub>rms</sub>	(°C/W)					
400	1,300	0.12	11.0	20.0	26.5	22.5	800	2,080,000	96	16	11	7.5	34	74NN3120(1)00(2)	R74NN3120(1)00(2)
400	1,300	0.15	13.0	22.0	26.5	22.5	800	2,080,000	120	16	8	8.7	31	74NN3150(1)00(2)	R74NN3150(1)00(2)
400	1,300	0.15	9.0	17.0	32.0	27.5	380	988,000	57	18	64	3.0	35	74NR3150(1)00(2)	R74NR3150(1)00(2)
400	1,300	0.18	9.0	17.0	32.0	27.5	380	988,000	68	18	53	3.3	35	74NR3180(1)00(2)	R74NR3180(1)00(2)
400	1,300	0.22	11.0	20.0	32.0	27.5	380	988,000	84	18	43	3.8	31	74NR3220(1)00(2)	R74NR3220(1)00(2)
400	1,300	0.27	11.0	20.0	32.0	27.5	380	988,000	103	18	35	4.2	31	74NR3270(1)00(2)	R74NR3270(1)00(2)
400	1,300	0.33	13.0	22.0	32.0	27.5	380	988,000	125	18	29	4.9	29	74NR3330(1)00(2)	R74NR3330(1)00(2)
400	1,300	0.39	13.0	22.0	32.0	27.5	380	988,000	148	18	24	5.3	29	74NR3390(1)00(2)	R74NR3390(1)00(2)
400	1,300	0.47	14.0	28.0	32.0	27.5	380	988,000	179	18	20	6.1	26	74NR3470(1)00(2)	R74NR3470(1)00(2)
400	1,300	0.56	14.0	28.0	32.0	27.5	380	988,000	213	18	17	6.7	26	74NR3560(1)00(2)	R74NR3560(1)00(2)
400	1,300	0.68	14.0	28.0	32.0	27.5	380	988,000	258	18	14	7.4	26	74NR3680(1)00(2)	R74NR3680(1)00(2)
400	1,300	0.82	18.0	33.0	32.0	27.5	380	988,000	312	18	16	7.5	23	74NR3820(1)00(2)	R74NR3820(1)00(2)
400	1,300	1.0	18.0	33.0	32.0	27.5	380	988,000	380	18	13	8.3	23	74NR4100(1)00(2)	R74NR4100(1)00(2)
400	1,300	0.47	11.0	22.0	41.5	37.5	180	468,000	85	20	20	6.0	27	74NW3470(1)00(2)	R74NW3470(1)00(2)
400	1,300	0.56	13.0	24.0	41.5	37.5	180	468,000	101	20	17	6.8	25	74NW3560(1)20(2)	R74NW3560(1)20(2)
400	1,300	0.68	13.0	24.0	41.5	37.5	180	468,000	122	20	14	7.5	25	74NW3680(1)00(2)	R74NW3680(1)00(2)
400	1,300	0.82	16.0	28.5	41.5	37.5	180	468,000	148	20	16	7.6	23	74NW3820(1)00(2)	R74NW3820(1)00(2)
400	1,300	1.0	16.0	28.5	41.5	37.5	180	468,000	180	20	13	8.3	23	74NW4100(1)00(2)	R74NW4100(1)00(2)
400	1,300	1.2	19.0	32.0	41.5	37.5	180	468,000	216	20	11	9.5	21	74NW4120(1)00(2)	R74NW4120(1)00(2)
400	1,300	1.5	20.0	40.0	41.5	37.5	180	468,000	270	20	8	11.2	19	74NW4150(1)20(2)	R74NW4150(1)20(2)
400	1,300	1.8	20.0	40.0	41.5	37.5	180	468,000	324	20	9	11.0	19	74NW4180(1)00(2)	R74NW4180(1)00(2)
400	1,300	2.2	24.0	44.0	41.5	37.5	180	468,000	396	20	7	12.7	17	74NW4220(1)00(2)	R74NW4220(1)00(2)
400	1,300	2.7	24.0	44.0	41.5	37.5	180	468,000	486	20	6	14.0	17	74NW4270(1)00(2)	R74NW4270(1)00(2)
400	1,300	3.3	30.0	45.0	41.5	37.5	180	468,000	594	20	5	16.1	16	74NW4330(1)00(2)	R74NW4330(1)00(2)
500	1,600	0.0010	4.0	9.0	13.0	10.0	6,000	19,200,000	6	9	637	0.3	79	745F1100(1)00(2)	R745F1100(1)00(2)
500	1,600	0.0012	4.0	9.0	13.0	10.0	6,000	19,200,000	7	9	531	0.4	79	745F1120(1)00(2)	R745F1120(1)00(2)
500	1,600	0.0015	4.0	9.0	13.0	10.0	6,000	19,200,000	9	9	424	0.5	79	745F1150(1)00(2)	R745F1150(1)00(2)
500	1,600	0.0018	4.0	9.0	13.0	10.0	6,000	19,200,000	11	9	354	0.6	79	745F1180(1)00(2)	R745F1180(1)00(2)
500	1,600	0.0022	5.0	11.0	13.0	10.0	6,000	19,200,000	13	9	289	0.7	69	745F1220(1)00(2)	R745F1220(1)00(2)
500	1,600	0.0027	5.0	11.0	13.0	10.0	6,000	19,200,000	16	9	236	0.8	69	745F1270(1)00(2)	R745F1270(1)00(2)
500	1,600	0.0033	6.0	12.0	13.0	10.0	6,000	19,200,000	20	9	193	1.0	64	745F1330(1)00(2)	R745F1330(1)00(2)
500	1,600	0.0039	6.0	12.0	13.0	10.0	6,000	19,200,000	23	9	163	1.2	64	745F1390(1)00(2)	R745F1390(1)00(2)
500	1,600	0.0047	6.0	12.0	13.0	10.0	6,000	19,200,000	28	9	135	1.5	64	745F1470(1)00(2)	R745F1470(1)00(2)
500	1,600	0.0056	6.0	12.0	13.0	10.0	6,000	19,200,000	34	9	114	1.7	64	745F1560(1)00(2)	R745F1560(1)00(2)
500	1,600	0.0068	6.0	12.0	13.0	10.0	6,000	19,200,000	41	9	94	1.8	64	745F1680(1)00(2)	R745F1680(1)00(2)
500	1,600	0.0082	6.0	12.0	13.0	10.0	6,000	19,200,000	49	9	78	2.0	64	745F1820(1)00(2)	R745F1820(1)00(2)
500	1,600	0.0015	4.0	10.0	18.0	15.0	4,500	14,400,000	7	10	424	0.5	65	745I1150(1)30(2)	R745I1150(1)30(2)
500	1,600	0.0015	5.0	11.0	18.0	15.0	4,500	14,400,000	7	10	424	0.5	60	745I1150(1)00(2)	R745I1150(1)00(2)
500	1,600	0.0018	4.0	10.0	18.0	15.0	4,500	14,400,000	8	10	354	0.6	65	745I1180(1)30(2)	R745I1180(1)30(2)
500	1,600	0.0018	5.0	11.0	18.0	15.0	4,500	14,400,000	8	10	354	0.6	65	745I1180(1)00(2)	R745I1180(1)00(2)
500	1,600	0.0022	4.0	10.0	18.0	15.0	4,500	14,400,000	10	10	289	0.7	65	745I1220(1)30(2)	R745I1220(1)30(2)
500	1,600	0.0022	5.0	11.0	18.0	15.0	4,500	14,400,000	10	10	289	0.7	60	745I1220(1)00(2)	R745I1220(1)00(2)
500	1,600	0.0027	4.0	10.0	18.0	15.0	4,500	14,400,000	12	10	236	0.8	65	745I1270(1)30(2)	R745I1270(1)30(2)
500	1,600	0.0027	5.0	11.0	18.0	15.0	4,500	14,400,000	12	10	236	0.8	60	745I1270(1)00(2)	R745I1270(1)00(2)
500	1,600	0.0033	4.0	10.0	18.0	15.0	4,500	14,400,000	15	10	193	1.0	65	745I1330(1)30(2)	R745I1330(1)30(2)
500	1,600	0.0033	5.0	11.0	18.0	15.0	4,500	14,400,000	15	10	193	1.0	60	745I1330(1)00(2)	R745I1330(1)00(2)
500	1,600	0.0039	4.0	10.0	18.0	15.0	4,500	14,400,000	18	10	163	1.2	65	745I1390(1)30(2)	R745I1390(1)30(2)
500	1,600	0.0039	5.0	11.0	18.0	15.0	4,500	14,400,000	18	10	163	1.2	60	745I1390(1)00(2)	R745I1390(1)00(2)
500	1,600	0.0047	4.0	10.0	18.0	15.0	4,500	14,400,000	21	10	135	1.5	65	745I1470(1)30(2)	R745I1470(1)30(2)
500	1,600	0.0047	5.0	11.0	18.0	15.0	4,500	14,400,000	21	10	135	1.5	60	745I1470(1)00(2)	R745I1470(1)00(2)
500	1,600	0.0056	5.0	11.0	18.0	15.0	4,500	14,400,000	25	10	114	1.7	60	745I1560(1)00(2)	R745I1560(1)00(2)
500	1,600	0.0068	6.0	12.0	18.0	15.0	4,500	14,400,000	31	10	94	2.0	56	745I1680(1)00(2)	R745I1680(1)00(2)
VAC	VDC	Cap Value	T	H	L	Lead Spacing (S)	dV/dt (V/µs)	Max K <sub>0</sub> (V <sup>2</sup> /µs)	A <sub>pk</sub>	nH	mΩ	A <sub>rms</sub>	(°C/W)	KEMET Internal Part Number	Customer Part Number
									I <sub>pk</sub>	ESL	ESR	I <sub>rms</sub> max (*)	R <sub>th</sub>		

(1) Insert lead and packaging code. See Ordering Options Table for available options.

(2) J = 5%, K = ±10%

(\*) I<sub>rms</sub> value that leads to a ΔT of ≈ 20°C in the hot spot > T<sub>HS</sub> = T<sub>AMB</sub> + ΔT = 85°C + 20°C = 105°C

**Table 1 – Ratings & Part Number Reference cont.**

VAC	VDC	Cap Value (µF)	Dimensions in mm			Lead Spacing (S)	dV/dt (V/µs)	Max K <sub>0</sub> (V <sup>2</sup> /µs)	I <sub>pk</sub>	ESL	ESR max	I <sub>rms</sub> max (*)	R <sub>th</sub>	KEMET Internal Part Number	Customer Part Number
										Lead Length 2x 4 mm	at 100 kHz	at 100 kHz, 85°C			
			T	H	L				A <sub>pk</sub>	nH	mΩ	A <sub>rms</sub>	(°C/W)		
500	1,600	0.0082	6.0	12.0	18.0	15.0	4,500	14,400,000	37	10	78	2.1	56	745I1820(1)00(2)	R745I1820(1)00(2)
500	1,600	0.010	6.0	12.0	18.0	15.0	4,500	14,400,000	45	10	64	2.4	56	745I2100(1)00(2)	R745I2100(1)00(2)
500	1,600	0.012	7.5	13.5	18.0	15.0	4,500	14,400,000	54	10	53	2.7	51	745I2120(1)00(2)	R745I2120(1)00(2)
500	1,600	0.015	7.5	13.5	18.0	15.0	4,500	14,400,000	68	10	42	3.0	51	745I2150(1)00(2)	R745I2150(1)00(2)
500	1,600	0.015	13.0	12.0	18.0	15.0	4,500	14,400,000	68	10	42	3.2	45	745I2150(1)60(2)	R745I2150(1)60(2)
500	1,600	0.018	8.5	14.5	18.0	15.0	4,500	14,400,000	81	10	35	3.4	48	745I2180(1)00(2)	R745I2180(1)00(2)
500	1,600	0.018	13.0	12.0	18.0	15.0	4,500	14,400,000	81	10	35	3.5	45	745I2180(1)60(2)	R745I2180(1)60(2)
500	1,600	0.022	10.0	16.0	18.0	15.0	4,500	14,400,000	99	10	29	4.0	44	745I2220(1)00(2)	R745I2220(1)00(2)
500	1,600	0.022	13.0	12.0	18.0	15.0	4,500	14,400,000	99	10	29	3.9	45	745I2220(1)60(2)	R745I2220(1)60(2)
500	1,600	0.027	10.0	16.0	18.0	15.0	4,500	14,400,000	122	10	24	4.4	44	745I2270(1)00(2)	R745I2270(1)00(2)
500	1,600	0.033	11.0	19.0	18.0	15.0	4,500	14,400,000	149	10	24	4.5	40	745I2330(1)00(2)	R745I2330(1)00(2)
500	1,600	0.018	6.0	15.0	26.5	22.5	1,800	5,760,000	32	16	35	3.6	43	745N2180(1)00(2)	R745N2180(1)00(2)
500	1,600	0.022	6.0	15.0	26.5	22.5	1,800	5,760,000	40	16	29	4.0	43	745N2220(1)00(2)	R745N2220(1)00(2)
500	1,600	0.027	7.0	16.0	26.5	22.5	1,800	5,760,000	49	16	24	4.5	41	745N2270(1)00(2)	R745N2270(1)00(2)
500	1,600	0.033	7.0	16.0	26.5	22.5	1,800	5,760,000	59	16	24	4.5	41	745N2330(1)00(2)	R745N2330(1)00(2)
500	1,600	0.039	8.5	17.0	26.5	22.5	1,800	5,760,000	70	16	20	5.1	38	745N2390(1)00(2)	R745N2390(1)00(2)
500	1,600	0.047	10.0	18.5	26.5	22.5	1,800	5,760,000	85	16	17	5.7	36	745N2470(1)00(2)	R745N2470(1)00(2)
500	1,600	0.056	10.0	18.5	26.5	22.5	1,800	5,760,000	101	16	14	6.3	36	745N2560(1)00(2)	R745N2560(1)00(2)
500	1,600	0.068	11.0	20.0	26.5	22.5	1,800	5,760,000	122	16	19	5.6	34	745N2680(1)00(2)	R745N2680(1)00(2)
500	1,600	0.082	13.0	22.0	26.5	22.5	1,800	5,760,000	148	16	16	6.4	31	745N2820(1)00(2)	R745N2820(1)00(2)
500	1,600	0.10	13.0	22.0	26.5	22.5	1,800	5,760,000	180	16	13	7.1	31	745N3100(1)00(2)	R745N3100(1)00(2)
500	1,600	0.10	9.0	17.0	32.0	27.5	500	1,600,000	50	18	95	2.4	35	745R3100(1)00(2)	R745R3100(1)00(2)
500	1,600	0.12	9.0	17.0	32.0	27.5	500	1,600,000	60	18	80	2.7	35	745R3120(1)00(2)	R745R3120(1)00(2)
500	1,600	0.15	9.0	17.0	32.0	27.5	500	1,600,000	75	18	64	3.0	35	745R3150(1)00(2)	R745R3150(1)00(2)
500	1,600	0.18	11.0	20.0	32.0	27.5	500	1,600,000	90	18	53	3.5	31	745R3180(1)00(2)	R745R3180(1)00(2)
500	1,600	0.22	11.0	20.0	32.0	27.5	500	1,600,000	110	18	43	3.8	31	745R3220(1)00(2)	R745R3220(1)00(2)
500	1,600	0.27	13.0	22.0	32.0	27.5	500	1,600,000	135	18	35	4.4	29	745R3270(1)00(2)	R745R3270(1)00(2)
500	1,600	0.33	14.0	28.0	32.0	27.5	500	1,600,000	165	18	29	5.1	26	745R3330(1)00(2)	R745R3330(1)00(2)
500	1,600	0.39	14.0	28.0	32.0	27.5	500	1,600,000	195	18	24	5.6	26	745R3390(1)00(2)	R745R3390(1)00(2)
500	1,600	0.47	14.0	28.0	32.0	27.5	500	1,600,000	235	18	20	6.1	26	745R3470(1)00(2)	R745R3470(1)00(2)
500	1,600	0.56	18.0	33.0	32.0	27.5	500	1,600,000	280	18	17	7.1	23	745R3560(1)00(2)	R745R3560(1)00(2)
500	1,600	0.68	18.0	33.0	32.0	27.5	500	1,600,000	340	18	14	7.9	23	745R3680(1)00(2)	R745R3680(1)00(2)
500	1,600	0.82	22.0	37.0	32.0	27.5	500	1,600,000	410	18	16	7.9	21	745R3820(1)00(2)	R745R3820(1)00(2)
500	1,600	1.0	22.0	37.0	32.0	27.5	500	1,600,000	500	18	13	8.7	21	745R4100(1)00(2)	R745R4100(1)00(2)
500	1,600	0.33	11.0	22.0	41.5	37.5	300	960,000	99	20	29	5.0	27	745W3330(1)00(2)	R745W3330(1)00(2)
500	1,600	0.39	13.0	24.0	41.5	37.5	300	960,000	117	20	24	5.7	25	745W3390(1)20(2)	R745W3390(1)20(2)
500	1,600	0.47	13.0	24.0	41.5	37.5	300	960,000	141	20	20	6.2	25	745W3470(1)00(2)	R745W3470(1)00(2)
500	1,600	0.56	16.0	28.5	41.5	37.5	300	960,000	168	20	17	7.2	23	745W3560(1)20(2)	R745W3560(1)20(2)
500	1,600	0.68	16.0	28.5	41.5	37.5	300	960,000	204	20	14	7.9	23	745W3680(1)00(2)	R745W3680(1)00(2)
500	1,600	0.82	19.0	32.0	41.5	37.5	300	960,000	246	20	16	7.9	21	745W3820(1)20(2)	R745W3820(1)20(2)
500	1,600	1.0	19.0	32.0	41.5	37.5	300	960,000	300	20	13	8.7	21	745W4100(1)00(2)	R745W4100(1)00(2)
500	1,600	1.2	20.0	40.0	41.5	37.5	300	960,000	360	20	11	10.0	19	745W4120(1)20(2)	R745W4120(1)20(2)
500	1,600	1.5	20.0	40.0	41.5	37.5	300	960,000	450	20	8	11.2	19	745W4150(1)00(2)	R745W4150(1)00(2)
500	1,600	1.8	24.0	44.0	41.5	37.5	300	960,000	540	20	9	11.5	17	745W4180(1)00(2)	R745W4180(1)00(2)
500	1,600	2.2	30.0	45.0	41.5	37.5	300	960,000	660	20	7	13.1	16	745W4220(1)20(2)	R745W4220(1)20(2)
600	2,000	0.00047	4.0	9.0	13.0	10.0	10,000	40,000,000	5	9	1,355	0.2	79	746F0470(1)00(2)	R746F0470(1)00(2)
600	2,000	0.00068	4.0	9.0	13.0	10.0	10,000	40,000,000	7	9	936	0.3	79	746F0680(1)00(2)	R746F0680(1)00(2)
600	2,000	0.00082	4.0	9.0	13.0	10.0	10,000	40,000,000	8	9	776	0.3	79	746F0820(1)00(2)	R746F0820(1)00(2)
600	2,000	0.0010	4.0	9.0	13.0	10.0	10,000	40,000,000	10	9	637	0.4	79	746F1100(1)00(2)	R746F1100(1)00(2)
600	2,000	0.0012	4.0	9.0	13.0	10.0	10,000	40,000,000	12	9	531	0.5	79	746F1120(1)00(2)	R746F1120(1)00(2)
600	2,000	0.0015	4.0	9.0	13.0	10.0	10,000	40,000,000	15	9	424	0.6	79	746F1150(1)00(2)	R746F1150(1)00(2)
600	2,000	0.0018	4.0	9.0	13.0	10.0	10,000	40,000,000	18	9	354	0.7	79	746F1180(1)00(2)	R746F1180(1)00(2)
VAC	VDC	Cap Value	T	H	L	Lead Spacing (S)	dV/dt (V/µs)	Max K <sub>0</sub> (V <sup>2</sup> /µs)	A <sub>pk</sub>	nH	mΩ	A <sub>rms</sub>	(°C/W)	KEMET Internal Part Number	Customer Part Number
									I <sub>pk</sub>	ESL	ESR	I <sub>rms</sub> max (*)	R <sub>th</sub>		

(1) Insert lead and packaging code. See Ordering Options Table for available options.

(2) J = 5%, K = ±10%

(\*) I<sub>rms</sub> value that leads to a ΔT of ≈ 20°C in the hot spot > T<sub>HS</sub> = T<sub>AMB</sub> + ΔT = 85°C + 20°C = 105°C

**Table 1 – Ratings & Part Number Reference cont.**

VAC	VDC	Cap Value (µF)	Dimensions in mm			Lead Spacing (S)	dV/dt (V/µs)	Max K <sub>0</sub> (V <sup>2</sup> /µs)	I <sub>pk</sub>	ESL	ESR max	I <sub>rms</sub> max (*)	R <sub>th</sub>	KEMET Internal Part Number	Customer Part Number
										Lead Length 2x 4 mm	at 100 kHz	at 100 kHz, 85°C			
			A <sub>pk</sub>	nH	mΩ				A <sub>rms</sub>	(°C/W)					
600	2,000	0.0022	5.0	11.0	13.0	10.0	10,000	40,000,000	22	9	289	0.8	69	746F1220(1)00(2)	R746F1220(1)00(2)
600	2,000	0.0027	5.0	11.0	13.0	10.0	10,000	40,000,000	27	9	236	1.0	69	746F1270(1)00(2)	R746F1270(1)00(2)
600	2,000	0.0033	6.0	12.0	13.0	10.0	10,000	40,000,000	33	9	193	1.2	64	746F1330(1)00(2)	R746F1330(1)00(2)
600	2,000	0.0039	6.0	12.0	13.0	10.0	10,000	40,000,000	39	9	163	1.4	64	746F1390(1)00(2)	R746F1390(1)00(2)
600	2,000	0.0047	6.0	12.0	13.0	10.0	10,000	40,000,000	47	9	135	1.5	64	746F1470(1)00(2)	R746F1470(1)00(2)
600	2,000	0.0056	6.0	12.0	13.0	10.0	10,000	40,000,000	56	9	114	1.7	64	746F1560(1)00(2)	R746F1560(1)00(2)
600	2,000	0.0068	6.0	12.0	13.0	10.0	10,000	40,000,000	68	9	94	1.8	64	746F1680(1)00(2)	R746F1680(1)00(2)
600	2,000	0.0082	6.0	12.0	13.0	10.0	10,000	40,000,000	82	9	78	2.0	64	746F1820(1)00(2)	R746F1820(1)00(2)
600	2,000	0.0023	4.0	10.0	18.0	15.0	9,500	38,000,000	22	10	277	0.9	65	746I1230(1)00(2)	R746I1230(1)00(2)
600	2,000	0.0027	4.0	10.0	18.0	15.0	9,500	38,000,000	26	10	236	1.0	65	746I1270(1)00(2)	R746I1270(1)00(2)
600	2,000	0.0039	5.0	11.0	18.0	15.0	9,500	38,000,000	37	10	163	1.4	60	746I1390(1)00(2)	R746I1390(1)00(2)
600	2,000	0.0047	5.0	11.0	18.0	15.0	9,500	38,000,000	45	10	135	1.6	60	746I1470(1)00(2)	R746I1470(1)00(2)
600	2,000	0.0068	6.0	12.0	18.0	15.0	9,500	38,000,000	65	10	94	2.0	56	746I1680(1)00(2)	R746I1680(1)00(2)
600	2,000	0.012	8.5	14.5	18.0	15.0	9,500	38,000,000	114	10	53	2.8	48	746I2120(1)00(2)	R746I2120(1)00(2)
600	2,000	0.015	8.5	14.5	18.0	15.0	9,500	38,000,000	143	10	42	3.1	48	746I2150(1)00(2)	R746I2150(1)00(2)
600	2,000	0.018	10.0	16.0	18.0	15.0	9,500	38,000,000	171	10	35	3.6	44	746I2180(1)00(2)	R746I2180(1)00(2)
700	2,000	0.00047	4.0	9.0	13.0	10.0	10,000	40,000,000	5	9	1,355	0.2	79	747F0470(1)00(2)	R747F0470(1)00(2)
700	2,000	0.00056	4.0	9.0	13.0	10.0	10,000	40,000,000	6	9	1,137	0.2	79	747F0560(1)00(2)	R747F0560(1)00(2)
700	2,000	0.00062	4.0	9.0	13.0	10.0	10,000	40,000,000	6	9	1,027	0.3	79	747F0620(1)00(2)	R747F0620(1)00(2)
700	2,000	0.00068	4.0	9.0	13.0	10.0	10,000	40,000,000	7	9	936	0.3	79	747F0680(1)00(2)	R747F0680(1)00(2)
700	2,000	0.00082	4.0	9.0	13.0	10.0	10,000	40,000,000	8	9	776	0.4	79	747F0820(1)00(2)	R747F0820(1)00(2)
700	2,000	0.00091	4.0	9.0	13.0	10.0	10,000	40,000,000	9	9	700	0.4	79	747F0910(1)00(2)	R747F0910(1)00(2)
700	2,000	0.0010	4.0	9.0	13.0	10.0	10,000	40,000,000	10	9	637	0.4	79	747F1100(1)00(2)	R747F1100(1)00(2)
700	2,000	0.0012	4.0	9.0	13.0	10.0	10,000	40,000,000	12	9	531	0.5	79	747F1120(1)00(2)	R747F1120(1)00(2)
700	2,000	0.0015	4.0	9.0	13.0	10.0	10,000	40,000,000	15	9	424	0.7	79	747F1150(1)00(2)	R747F1150(1)00(2)
700	2,000	0.0018	4.0	9.0	13.0	10.0	10,000	40,000,000	18	9	354	0.8	79	747F1180(1)00(2)	R747F1180(1)00(2)
700	2,000	0.0022	5.0	11.0	13.0	10.0	10,000	40,000,000	22	9	289	1.0	69	747F1220(1)00(2)	R747F1220(1)00(2)
700	2,000	0.0027	5.0	11.0	13.0	10.0	10,000	40,000,000	27	9	236	1.1	69	747F1270(1)00(2)	R747F1270(1)00(2)
700	2,000	0.0033	6.0	12.0	13.0	10.0	10,000	40,000,000	33	9	193	1.3	64	747F1330(1)00(2)	R747F1330(1)00(2)
700	2,000	0.0036	6.0	12.0	13.0	10.0	10,000	40,000,000	36	9	177	1.3	64	747F1360(1)00(2)	R747F1360(1)00(2)
700	2,000	0.0039	6.0	12.0	13.0	10.0	10,000	40,000,000	39	9	163	1.4	64	747F1390(1)00(2)	R747F1390(1)00(2)
700	2,000	0.0047	6.0	12.0	13.0	10.0	10,000	40,000,000	47	9	135	1.5	64	747F1470(1)00(2)	R747F1470(1)00(2)
700	2,000	0.0056	6.0	12.0	13.0	10.0	10,000	40,000,000	56	9	114	1.7	64	747F1560(1)00(2)	R747F1560(1)00(2)
700	2,000	0.00047	4.0	10.0	18.0	15.0	9,500	38,000,000	4	10	1,355	0.2	65	747I0470(1)30(2)	R747I0470(1)30(2)
700	2,000	0.00068	4.0	10.0	18.0	15.0	9,500	38,000,000	6	10	936	0.3	65	747I0680(1)30(2)	R747I0680(1)30(2)
700	2,000	0.00082	4.0	10.0	18.0	15.0	9,500	38,000,000	8	10	776	0.4	65	747I0820(1)30(2)	R747I0820(1)30(2)
700	2,000	0.0010	4.0	10.0	18.0	15.0	9,500	38,000,000	10	10	637	0.4	65	747I1100(1)30(2)	R747I1100(1)30(2)
700	2,000	0.0010	5.0	11.0	18.0	15.0	9,500	38,000,000	10	10	637	0.4	60	747I1100(1)00(2)	R747I1100(1)00(2)
700	2,000	0.0012	4.0	10.0	18.0	15.0	9,500	38,000,000	11	10	531	0.5	65	747I1120(1)30(2)	R747I1120(1)30(2)
700	2,000	0.0012	5.0	11.0	18.0	15.0	9,500	38,000,000	11	10	531	0.5	60	747I1120(1)00(2)	R747I1120(1)00(2)
700	2,000	0.0015	4.0	10.0	18.0	15.0	9,500	38,000,000	14	10	424	0.7	65	747I1150(1)30(2)	R747I1150(1)30(2)
700	2,000	0.0015	5.0	11.0	18.0	15.0	9,500	38,000,000	14	10	424	0.7	60	747I1150(1)00(2)	R747I1150(1)00(2)
700	2,000	0.0018	4.0	10.0	18.0	15.0	9,500	38,000,000	17	10	354	0.8	65	747I1180(1)30(2)	R747I1180(1)30(2)
700	2,000	0.0018	5.0	11.0	18.0	15.0	9,500	38,000,000	17	10	354	0.8	60	747I1180(1)00(2)	R747I1180(1)00(2)
700	2,000	0.0022	4.0	10.0	18.0	15.0	9,500	38,000,000	21	10	289	1.0	65	747I1220(1)30(2)	R747I1220(1)30(2)
700	2,000	0.0022	5.0	11.0	18.0	15.0	9,500	38,000,000	21	10	289	1.0	60	747I1220(1)00(2)	R747I1220(1)00(2)
700	2,000	0.0027	5.0	11.0	18.0	15.0	9,500	38,000,000	26	10	236	1.2	60	747I1270(1)00(2)	R747I1270(1)00(2)
700	2,000	0.0033	5.0	11.0	18.0	15.0	9,500	38,000,000	31	10	193	1.3	60	747I1330(1)00(2)	R747I1330(1)00(2)
700	2,000	0.0039	6.0	12.0	18.0	15.0	9,500	38,000,000	37	10	163	1.5	56	747I1390(1)00(2)	R747I1390(1)00(2)
700	2,000	0.0047	6.0	12.0	18.0	15.0	9,500	38,000,000	45	10	135	1.6	56	747I1470(1)00(2)	R747I1470(1)00(2)
700	2,000	0.0056	6.0	12.0	18.0	15.0	9,500	38,000,000	53	10	114	1.8	56	747I1560(1)00(2)	R747I1560(1)00(2)
700	2,000	0.0068	7.5	13.5	18.0	15.0	9,500	38,000,000	65	10	94	2.1	51	747I1680(1)00(2)	R747I1680(1)00(2)
VAC	VDC	Cap Value	T	H	L	Lead Spacing (S)	dV/dt (V/µs)	Max K <sub>0</sub> (V <sup>2</sup> /µs)	A <sub>pk</sub>	nH	mΩ	A <sub>rms</sub>	(°C/W)	KEMET Internal Part Number	Customer Part Number
									I <sub>pk</sub>	ESL	ESR	I <sub>rms</sub> max (*)	R <sub>th</sub>		

(1) Insert lead and packaging code. See Ordering Options Table for available options.

(2) J = 5%, K = ±10%

(\*) I<sub>rms</sub> value that leads to a ΔT of ≈ 20°C in the hot spot > T<sub>HS</sub> = T<sub>AMB</sub> + ΔT = 85°C + 20°C = 105°C

**Table 1 – Ratings & Part Number Reference cont.**

VAC	VDC	Cap Value (µF)	Dimensions in mm			Lead Spacing (S)	dV/dt (V/µs)	Max K <sub>0</sub> (V <sup>2</sup> /µs)	I <sub>pk</sub>	ESL	ESR max	I <sub>rms</sub> max (*)	R <sub>th</sub>	KEMET Internal Part Number	Customer Part Number
										Lead Length 2x 4 mm	at 100 kHz	at 100 kHz, 85°C			
			A <sub>pk</sub>	nH	mΩ				A <sub>rms</sub>	(°C/W)					
700	2,000	0.0082	7.5	13.5	18.0	15.0	9,500	38,000,000	78	10	78	2.3	51	747I1820(1)00(2)	R747I1820(1)00(2)
700	2,000	0.0082	9.0	12.5	18.0	15.0	9,500	38,000,000	78	10	78	2.3	50	747I1820(1)60(2)	R747I1820(1)60(2)
700	2,000	0.010	8.5	14.5	18.0	15.0	9,500	38,000,000	95	10	64	2.6	48	747I2100(1)00(2)	R747I2100(1)00(2)
700	2,000	0.010	13.0	12.0	18.0	15.0	9,500	38,000,000	95	10	64	2.6	45	747I2100(1)60(2)	R747I2100(1)60(2)
700	2,000	0.012	10.0	16.0	18.0	15.0	9,500	38,000,000	114	10	66	2.6	44	747I2120(1)00(2)	R747I2120(1)00(2)
700	2,000	0.012	13.0	12.0	18.0	15.0	9,500	38,000,000	114	10	66	2.6	45	747I2120(1)60(2)	R747I2120(1)60(2)
700	2,000	0.015	10.0	16.0	18.0	15.0	9,500	38,000,000	143	10	53	2.9	44	747I2150(1)00(2)	R747I2150(1)00(2)
700	2,000	0.018	11.0	19.0	18.0	15.0	9,500	38,000,000	171	10	44	3.4	40	747I2180(1)00(2)	R747I2180(1)00(2)
700	2,000	0.0082	6.0	15.0	26.5	22.5	4,500	18,000,000	37	16	78	2.4	43	747N1820(1)00(2)	R747N1820(1)00(2)
700	2,000	0.010	6.0	15.0	26.5	22.5	4,500	18,000,000	45	16	64	2.7	43	747N2100(1)00(2)	R747N2100(1)00(2)
700	2,000	0.012	6.0	15.0	26.5	22.5	4,500	18,000,000	54	16	66	2.6	43	747N2120(1)00(2)	R747N2120(1)00(2)
700	2,000	0.015	6.0	15.0	26.5	22.5	4,500	18,000,000	68	16	53	2.9	43	747N2150(1)00(2)	R747N2150(1)00(2)
700	2,000	0.018	7.0	16.0	26.5	22.5	4,500	18,000,000	81	16	44	3.3	41	747N2180(1)00(2)	R747N2180(1)00(2)
700	2,000	0.022	8.5	17.0	26.5	22.5	4,500	18,000,000	99	16	36	3.8	38	747N2220(1)00(2)	R747N2220(1)00(2)
700	2,000	0.027	8.5	17.0	26.5	22.5	4,500	18,000,000	122	16	29	4.2	38	747N2270(1)00(2)	R747N2270(1)00(2)
700	2,000	0.033	10.0	18.5	26.5	22.5	4,500	18,000,000	149	16	29	4.4	36	747N2330(1)00(2)	R747N2330(1)00(2)
700	2,000	0.039	10.0	18.5	26.5	22.5	4,500	18,000,000	176	16	24	4.8	36	747N2390(1)00(2)	R747N2390(1)00(2)
700	2,000	0.047	11.0	20.0	26.5	22.5	4,500	18,000,000	212	16	20	5.4	34	747N2470(1)00(2)	R747N2470(1)00(2)
700	2,000	0.056	13.0	22.0	26.5	22.5	4,500	18,000,000	252	16	17	6.1	31	747N2560(1)00(2)	R747N2560(1)00(2)
700	2,000	0.068	13.0	22.0	26.5	22.5	4,500	18,000,000	306	16	19	5.8	31	747N2680(1)00(2)	R747N2680(1)00(2)
700	2,000	0.039	9.0	17.0	32.0	27.5	700	2,800,000	27	18	24	4.8	35	747R2390(1)00(2)	R747R2390(1)00(2)
700	2,000	0.047	9.0	17.0	32.0	27.5	700	2,800,000	33	18	20	5.3	35	747R2470(1)00(2)	R747R2470(1)00(2)
700	2,000	0.056	9.0	17.0	32.0	27.5	700	2,800,000	39	18	17	5.8	35	747R2560(1)00(2)	R747R2560(1)00(2)
700	2,000	0.068	11.0	20.0	32.0	27.5	700	2,800,000	48	18	19	5.8	31	747R2680(1)00(2)	R747R2680(1)00(2)
700	2,000	0.082	11.0	20.0	32.0	27.5	700	2,800,000	57	18	16	6.4	31	747R2820(1)00(2)	R747R2820(1)00(2)
700	2,000	0.10	13.0	22.0	32.0	27.5	700	2,800,000	70	18	13	7.3	29	747R3100(1)00(2)	R747R3100(1)00(2)
700	2,000	0.12	13.0	22.0	32.0	27.5	700	2,800,000	84	18	11	8.1	29	747R3120(1)00(2)	R747R3120(1)00(2)
700	2,000	0.15	14.0	28.0	32.0	27.5	700	2,800,000	105	18	8	9.5	26	747R3150(1)00(2)	R747R3150(1)00(2)
700	2,000	0.18	14.0	28.0	32.0	27.5	700	2,800,000	126	18	9	9.3	26	747R3180(1)00(2)	R747R3180(1)00(2)
700	2,000	0.22	18.0	33.0	32.0	27.5	700	2,800,000	154	18	7	11.0	23	747R3220(1)00(2)	R747R3220(1)00(2)
700	2,000	0.27	18.0	33.0	32.0	27.5	700	2,800,000	189	18	6	12.2	23	747R3270(1)00(2)	R747R3270(1)00(2)
700	2,000	0.33	22.0	37.0	32.0	27.5	700	2,800,000	231	18	5	14.1	21	747R3330(1)00(2)	R747R3330(1)00(2)
700	2,000	0.15	11.0	22.0	41.5	37.5	400	1,600,000	60	20	8	9.3	27	747W3150(1)00(2)	R747W3150(1)00(2)
700	2,000	0.18	13.0	24.0	41.5	37.5	400	1,600,000	72	20	9	9.5	25	747W3180(1)00(2)	R747W3180(1)00(2)
700	2,000	0.22	16.0	28.5	41.5	37.5	400	1,600,000	88	20	7	11.1	23	747W3220(1)20(2)	R747W3220(1)20(2)
700	2,000	0.27	16.0	28.5	41.5	37.5	400	1,600,000	108	20	6	12.3	23	747W3270(1)00(2)	R747W3270(1)00(2)
700	2,000	0.33	19.0	32.0	41.5	37.5	400	1,600,000	132	20	5	14.2	21	747W3330(1)20(2)	R747W3330(1)20(2)
700	2,000	0.39	19.0	32.0	41.5	37.5	400	1,600,000	156	20	4	15.4	21	747W3390(1)00(2)	R747W3390(1)00(2)
700	2,000	0.47	20.0	40.0	41.5	37.5	400	1,600,000	188	20	3	17.7	19	747W3470(1)20(2)	R747W3470(1)20(2)
700	2,000	0.56	20.0	40.0	41.5	37.5	400	1,600,000	224	20	3	19.4	19	747W3560(1)00(2)	R747W3560(1)00(2)
700	2,000	0.68	24.0	44.0	41.5	37.5	400	1,600,000	272	20	2	22.3	17	747W3680(1)00(2)	R747W3680(1)00(2)
700	2,000	0.82	24.0	44.0	41.5	37.5	400	1,600,000	328	20	6	14.1	17	747W3820(1)00(2)	R747W3820(1)00(2)
700	2,000	1.0	30.0	45.0	41.5	37.5	400	1,600,000	400	20	5	16.2	16	747W4100(1)00(2)	R747W4100(1)00(2)
900	2,200	0.0010	6.0	15.0	26.5	22.5	2,500	11,000,000	3	16	637	0.6	43	749N1100(1)00(2)	R749N1100(1)00(2)
900	2,200	0.0012	6.0	15.0	26.5	22.5	2,500	11,000,000	3	16	531	0.7	43	749N1120(1)00(2)	R749N1120(1)00(2)
900	2,200	0.0015	6.0	15.0	26.5	22.5	2,500	11,000,000	4	16	424	0.8	43	749N1150(1)00(2)	R749N1150(1)00(2)
900	2,200	0.0018	6.0	15.0	26.5	22.5	2,500	11,000,000	5	16	354	1.0	43	749N1180(1)00(2)	R749N1180(1)00(2)
900	2,200	0.0022	6.0	15.0	26.5	22.5	2,500	11,000,000	6	16	289	1.2	43	749N1220(1)00(2)	R749N1220(1)00(2)
900	2,200	0.0027	6.0	15.0	26.5	22.5	2,500	11,000,000	7	16	236	1.4	43	749N1270(1)00(2)	R749N1270(1)00(2)
900	2,200	0.0033	6.0	15.0	26.5	22.5	2,500	11,000,000	8	16	193	1.5	43	749N1330(1)00(2)	R749N1330(1)00(2)
900	2,200	0.0039	6.0	15.0	26.5	22.5	2,500	11,000,000	10	16	163	1.7	43	749N1390(1)00(2)	R749N1390(1)00(2)
900	2,200	0.0047	6.0	15.0	26.5	22.5	2,500	11,000,000	12	16	135	1.8	43	749N1470(1)00(2)	R749N1470(1)00(2)

(1) Insert lead and packaging code. See Ordering Options Table for available options.

(2) J = 5%, K = ±10%

(\*) I<sub>rms</sub> value that leads to a ΔT of ≈ 20°C in the hot spot > T<sub>HS</sub> = T<sub>AMB</sub> + ΔT = 85°C + 20°C = 105°C

**Table 1 – Ratings & Part Number Reference cont.**

VAC	VDC	Cap Value (µF)	Dimensions in mm			Lead Spacing (S)	dV/dt (V/µs)	Max K <sub>0</sub> (V <sup>2</sup> /µs)	I <sub>pk</sub>	ESL	ESR max	I <sub>rms</sub> max (*)	R <sub>th</sub>	KEMET Internal Part Number	Customer Part Number
										Lead Length 2x 4 mm	at 100 kHz	at 100 kHz, 85°C			
			A <sub>pk</sub>	nH	mΩ				A <sub>rms</sub>	(°C/W)					
900	2,200	0.0056	6.0	15.0	26.5	22.5	2,500	11,000,000	14	16	114	2.0	43	749N1560(1)00(2)	R749N1560(1)00(2)
900	2,200	0.0068	6.0	15.0	26.5	22.5	2,500	11,000,000	17	16	94	2.2	43	749N1680(1)00(2)	R749N1680(1)00(2)
900	2,200	0.0082	7.0	16.0	26.5	22.5	2,500	11,000,000	21	16	78	2.5	41	749N1820(1)00(2)	R749N1820(1)00(2)
900	2,200	0.010	7.0	16.0	26.5	22.5	2,500	11,000,000	25	16	64	2.8	41	749N2100(1)00(2)	R749N2100(1)00(2)
900	2,200	0.012	8.5	17.0	26.5	22.5	2,500	11,000,000	30	16	66	2.8	38	749N2120(1)00(2)	R749N2120(1)00(2)
900	2,200	0.015	10.0	18.5	26.5	22.5	2,500	11,000,000	38	16	53	3.2	36	749N2150(1)00(2)	R749N2150(1)00(2)
900	2,200	0.018	10.0	18.5	26.5	22.5	2,500	11,000,000	45	16	44	3.6	36	749N2180(1)00(2)	R749N2180(1)00(2)
900	2,200	0.022	11.0	20.0	26.5	22.5	2,500	11,000,000	55	16	36	4.0	34	749N2220(1)00(2)	R749N2220(1)00(2)
900	2,200	0.027	13.0	22.0	26.5	22.5	2,500	11,000,000	68	16	29	4.7	31	749N2270(1)00(2)	R749N2270(1)00(2)
900	2,200	0.033	13.0	22.0	26.5	22.5	2,500	11,000,000	83	16	29	4.7	31	749N2330(1)00(2)	R749N2330(1)00(2)
900	2,200	0.022	9.0	17.0	32.0	27.5	1,500	6,600,000	33	18	36	4.0	35	749R2220(1)00(2)	R749R2220(1)00(2)
900	2,200	0.027	9.0	17.0	32.0	27.5	1,500	6,600,000	41	18	29	4.4	35	749R2270(1)00(2)	R749R2270(1)00(2)
900	2,200	0.033	11.0	20.0	32.0	27.5	1,500	6,600,000	50	18	29	4.7	31	749R2330(1)00(2)	R749R2330(1)00(2)
900	2,200	0.039	11.0	20.0	32.0	27.5	1,500	6,600,000	59	18	24	5.1	31	749R2390(1)00(2)	R749R2390(1)00(2)
900	2,200	0.047	13.0	22.0	32.0	27.5	1,500	6,600,000	71	18	20	5.8	29	749R2470(1)00(2)	R749R2470(1)00(2)
900	2,200	0.056	13.0	22.0	32.0	27.5	1,500	6,600,000	84	18	17	6.4	29	749R2560(1)00(2)	R749R2560(1)00(2)
900	2,200	0.068	14.0	28.0	32.0	27.5	1,500	6,600,000	102	18	19	6.4	26	749R2680(1)00(2)	R749R2680(1)00(2)
900	2,200	0.082	14.0	28.0	32.0	27.5	1,500	6,600,000	123	18	16	7.0	26	749R2820(1)00(2)	R749R2820(1)00(2)
900	2,200	0.10	18.0	33.0	32.0	27.5	1,500	6,600,000	150	18	13	8.3	23	749R3100(1)00(2)	R749R3100(1)00(2)
900	2,200	0.12	18.0	33.0	32.0	27.5	1,500	6,600,000	180	18	11	9.1	23	749R3120(1)00(2)	R749R3120(1)00(2)
900	2,200	0.15	18.0	33.0	32.0	27.5	1,500	6,600,000	225	18	8	10.1	23	749R3150(1)00(2)	R749R3150(1)00(2)
900	2,200	0.068	11.0	22.0	41.5	37.5	900	3,960,000	61	20	19	6.3	27	749W2680(1)00(2)	R749W2680(1)00(2)
900	2,200	0.082	13.0	24.0	41.5	37.5	900	3,960,000	74	20	16	7.1	25	749W2820(1)20(2)	R749W2820(1)20(2)
900	2,200	0.10	13.0	24.0	41.5	37.5	900	3,960,000	90	20	13	7.9	25	749W3100(1)00(2)	R749W3100(1)00(2)
900	2,200	0.12	16.0	28.5	41.5	37.5	900	3,960,000	108	20	11	9.1	23	749W3120(1)20(2)	R749W3120(1)20(2)
900	2,200	0.15	16.0	28.5	41.5	37.5	900	3,960,000	135	20	8	10.2	23	749W3150(1)00(2)	R749W3150(1)00(2)
900	2,200	0.18	19.0	32.0	41.5	37.5	900	3,960,000	162	20	9	10.5	21	749W3180(1)20(2)	R749W3180(1)20(2)
900	2,200	0.22	19.0	32.0	41.5	37.5	900	3,960,000	198	20	7	11.6	21	749W3220(1)00(2)	R749W3220(1)00(2)
900	2,200	0.27	20.0	40.0	41.5	37.5	900	3,960,000	243	20	6	13.5	19	749W3270(1)00(2)	R749W3270(1)00(2)
900	2,200	0.33	20.0	40.0	41.5	37.5	900	3,960,000	297	20	5	14.9	19	749W3330(1)00(2)	R749W3330(1)00(2)
900	2,200	0.39	24.0	44.0	41.5	37.5	900	3,960,000	351	20	4	16.9	17	749W3390(1)00(2)	R749W3390(1)00(2)
900	2,200	0.47	24.0	44.0	41.5	37.5	900	3,960,000	423	20	3	18.5	17	749W3470(1)00(2)	R749W3470(1)00(2)
VAC	VDC	Cap Value	T	H	L	Lead Spacing (S)	dV/dt (V/µs)	Max K <sub>0</sub> (V <sup>2</sup> /µs)	A <sub>pk</sub>	nH	mΩ	A <sub>rms</sub>	(°C/W)	KEMET Internal Part Number	Customer Part Number
									I <sub>pk</sub>	ESL	ESR	I <sub>rms</sub> max (*)	R <sub>th</sub>		

(1) Insert lead and packaging code. See Ordering Options Table for available options.

(2) J = 5%, K = ±10%

(\*) I<sub>rms</sub> value that leads to a ΔT of ≈ 20°C in the hot spot > T<sub>HS</sub> = T<sub>AMB</sub> + ΔT = 85°C + 20°C = 105°C

## Soldering Process

The implementation of the RoHS directive has resulted in the selection of SnAgCu (SAC) alloys or SnCu alloys as a primary solder. This has increased the liquidus temperature from that of 183°C for SnPb eutectic alloy to 217 – 221°C for the new alloys. As a result, the heat stress to the components, even in wave soldering, has increased considerably due to higher pre-heat and wave temperatures. Polypropylene capacitors are especially sensitive to heat (the melting point of polypropylene is 160 – 170°C). Wave soldering can be destructive, especially for mechanically small polypropylene capacitors (with lead spacing of 5 mm to 15 mm), and great care has to be taken during soldering. The recommended solder profiles from KEMET should be used. Please consult KEMET with any questions. In general, the wave soldering curve from IEC Publication 61760–1 Edition 2 serves as a solid guideline for successful soldering. Please see Figure 1.

Reflow soldering is not recommended for through-hole film capacitors. Exposing capacitors to a soldering profile in excess of the above recommended limits may result in degradation or permanent damage to the capacitors.

Do not place the polypropylene capacitor through an adhesive curing oven to cure resin for surface mount components. Insert through-hole parts after the curing of surface mount parts. Consult KEMET to discuss the actual temperature profile in the oven, if through-hole components must pass through the adhesive curing process. A maximum two soldering cycles is recommended. Please allow time for the capacitor surface temperature to return to a normal temperature before the second soldering cycle.

### Manual Soldering Recommendations

The following is recommended for manual soldering with a soldering iron.



The soldering iron tip temperature should be set at 350°C (+10°C maximum) with the soldering duration not to exceed more than 3 seconds.

### Wave Soldering Recommendations

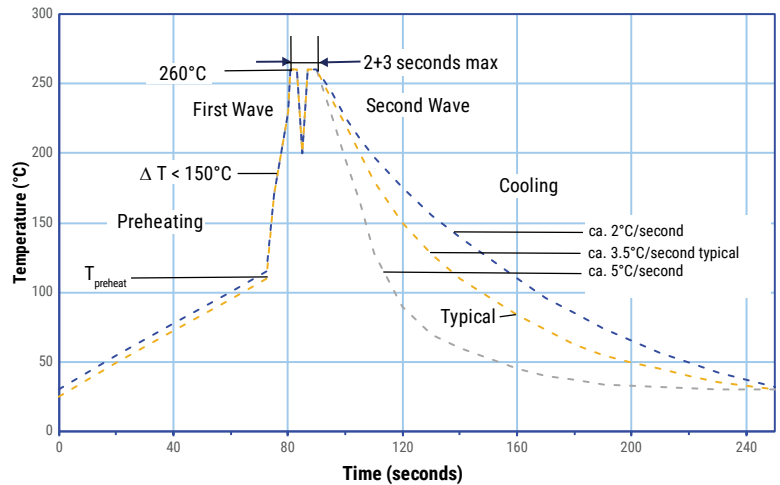



## Soldering Process cont.

### Wave Soldering Recommendations cont.

1. The table indicates the maximum set-up temperature of the soldering process  
Figure 1.

Dielectric Film Material	Maximum Preheat Temperature		Maximum Peak Soldering Temperature	
	Capacitor Pitch ≤ 15 mm	Capacitor Pitch > 15 mm	Capacitor Pitch ≤ 15 mm	Capacitor Pitch > 15 mm
Polyester	130°C	130°C	270°C	270°C
Polypropylene	110°C	130°C	260°C	270°C
Paper	130°C	140°C	270°C	270°C
Polyphenylene Sulphide	150°C	160°C	270°C	270°C

2. The maximum temperature measured inside the capacitor:

Set the temperature so that inside the element the maximum temperature is below the limit:

Dielectric Film Material	Maximum temperature measured inside the element
Polyester	160°C
Polypropylene	110°C
Paper	160°C
Polyphenylene Sulphide	160°C

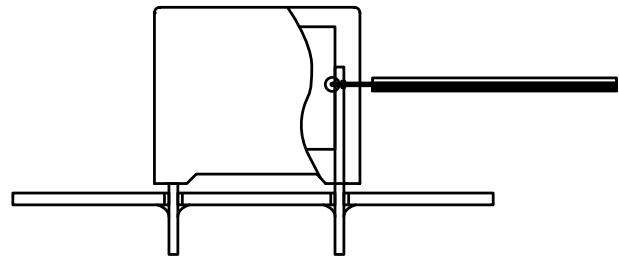

*Temperature monitored inside the capacitor.*

### Selective Soldering Recommendations

Selective dip soldering is a variation of reflow soldering. In this method, the printed circuit board with through-hole components to be soldered is preheated and transported over the solder bath as in normal flow soldering without touching the solder. When the board is over the bath, it is stopped and pre-designed solder pots are lifted from the bath with molten solder only at the places of the selected components, and pressed against the lower surface of the board to solder the components.

The temperature profile for selective soldering is similar to the double wave flow soldering outlined in this document, **however, instead of two baths, there is only one bath with a time from 3 to 10 seconds.** In selective soldering, the risk of overheating is greater than in double wave flow soldering. Great care must be taken so that the parts are not overheated.

## Construction

### 2 Sections

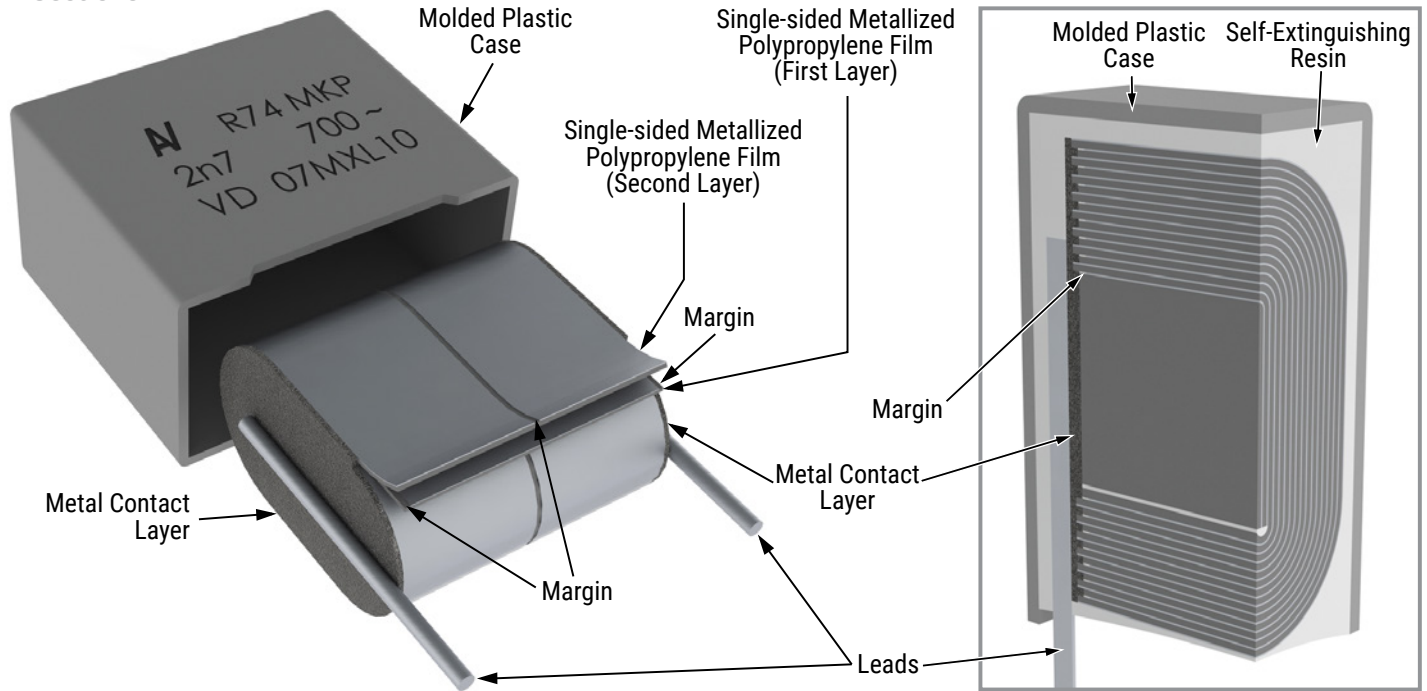

### Winding Schemes

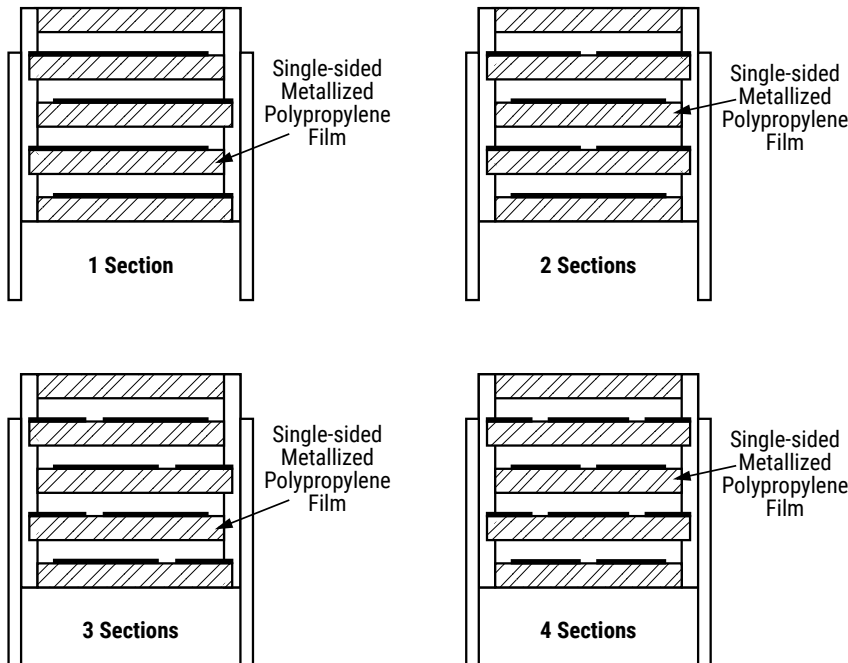

## Marking

Pitch – 10, 15 & 22.5

Marking Variants\*

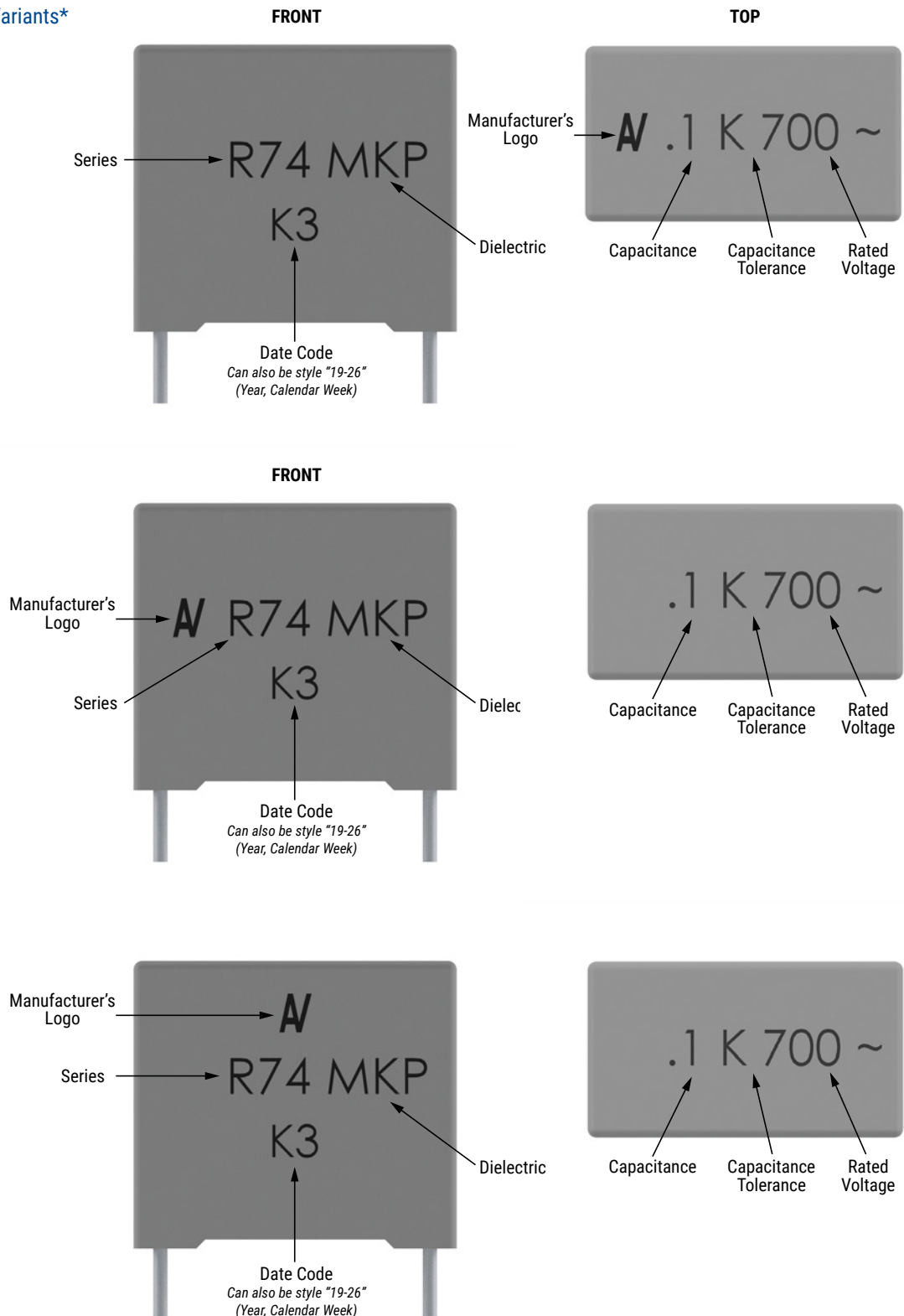

\* Differences are caused by technology (Clichee or ink) and technic (production line).

## Marking cont.

Pitch – 10, 15, 22.5, 27.5 & 37.5

Marking Variants\*

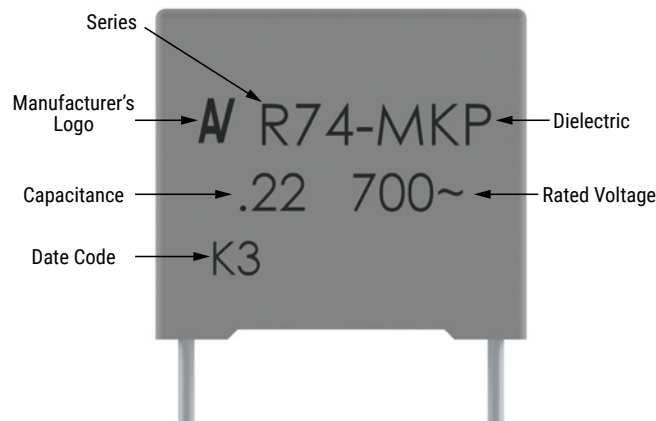
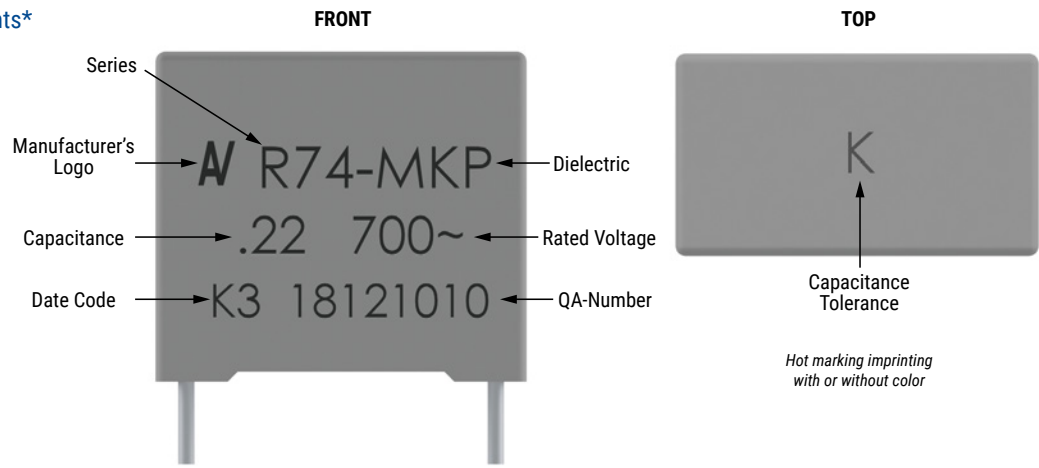

Pitch – 22.5, 27.5 & 37.5

Marking Variants\*

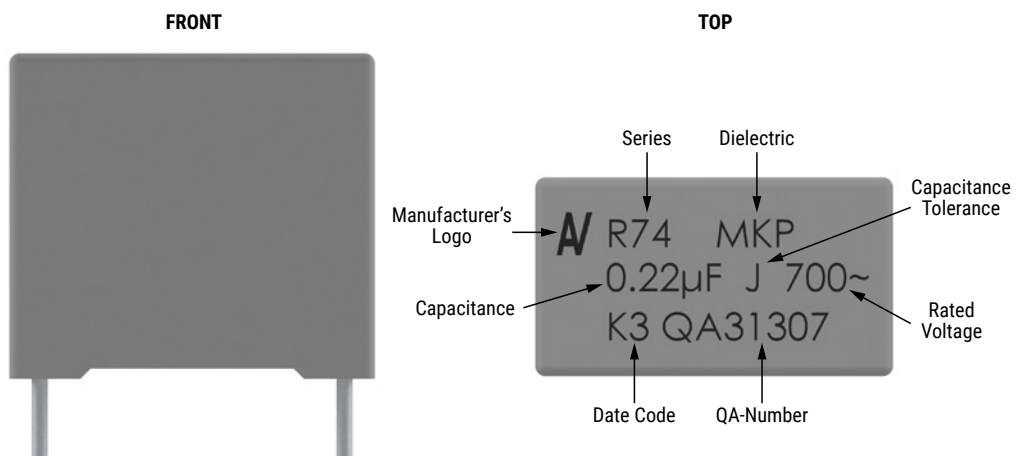

\* Differences are caused by technology (Clichee or ink) and technic (production line).

## Marking cont.

Manufacturing Date Code (IEC-60062)			
Year	Code	Month	Code
2020	M	January	1
2021	N	February	2
2022	P	March	3
2023	R	April	4
2024	S	May	5
2025	T	June	6
2026	U	July	7
2027	V	August	8
2028	W	September	9
2029	X	October	0
2030	A	November	N
2031	B	December	D
2032	C		
2033	D		
2034	E		
2035	F		
2036	H		
2037	J		
2038	K		
2039	L		
2040	M		

## Packaging Quantities

Lead Spacing	Thickness (mm)	Height (mm)	Length (mm)	Bulk Short Leads	Bulk Long Leads		Standard Reel ø 355 mm	Large Reel ø 500 mm	Ammo Taped
	Lead and Packaging Code			AA - JB JE - JH	JM	40 - 50	GY	CK	DQ
10	4.0	9.0	13.0	2,000	2,200	1,800	750	1,500	1,000
	5.0	11.0	13.0	1,300	2,000	1,500	600	1,250	800
	6.0	12.0	13.0	1,000	1,800	1,200	500	1,000	680
15	4.0	10.0	18.0	2,500	1,500	1,500	750	1,500	1,000
	5.0	11.0	18.0	2,000	1,250	1,000	600	1,250	800
	6.0	12.0	18.0	1,750	1,000	900	500	1,000	680
	7.5	13.5	18.0	1,000	800	700	350	800	500
	8.5	14.5	18.0	1,000	650	500	300	700	440
	9.0	12.5	18.0	1,000	700	520	270	650	410
	10.0	16.0	18.0	750	550	500	270	600	380
	11.0	19.0	18.0	450	400	350	270	500	340
	13.0	12.0	18.0	750	520	490	200	480	280
22.5	6.0	15.0	26.5	805	450	500	300	700	464
	7.0	16.0	26.5	700	450	500	250	550	380
	8.5	17.0	26.5	468	350	300	250	450	280
	10.0	18.5	26.5	396	350	300	160	350	235
	11.0	20.0	26.5	360	200	250	160	350	217
	13.0	22.0	26.5	300	150	200	130	300	-
27.5	9.0	17.0	32.0	816	-	408	230	450	-
	11.0	20.0	32.0	560	-	336	190	350	-
	13.0	12.0	32.0	672	-	288	-	-	-
	13.0	22.0	32.0	480	-	288	150	300	-
	13.0	25.0	32.0	480	-	288	-	-	-
	14.0	28.0	32.0	352	-	176	-	-	-
	18.0	33.0	32.0	256	-	128	-	-	-
	22.0	37.0	32.0	168	-	112	-	-	-
	24.0	15.0	32.0	336	-	144	-	-	-
37.5	11.0	22.0	41.5	420	-	252	-	-	-
	13.0	24.0	41.5	360	-	216	-	-	-
	16.0	28.5	41.5	216	-	108	-	-	-
	19.0	32.0	41.5	192	-	96	-	-	-
	20.0	40.0	41.5	126	-	84	-	-	-
	24.0	15.0	41.5	252	-	108	-	-	-
	24.0	19.0	41.5	216	-	108	-	-	-
	24.0	44.0	41.5	108	-	72	-	-	-
	30.0	45.0	41.5	90	-	60	-	-	-

## Lead Taping & Packaging (IEC 60286-2)

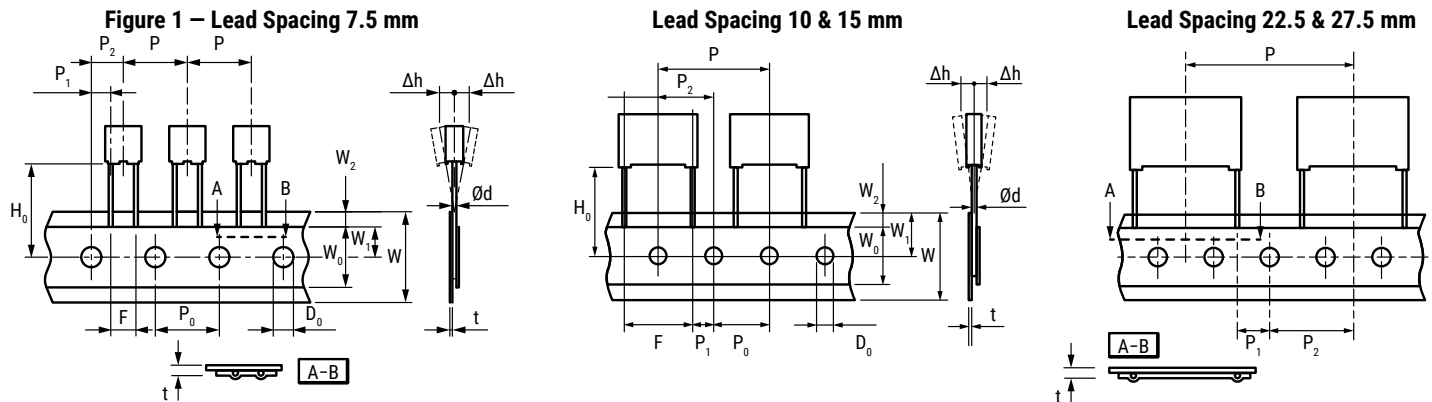

## Taping Specification

Description	Symbol	Dimensions (mm)					Tolerance
		Lead Spacing					
		7.5 Figure 1	10.0 Figure 2	15.0 Figure 2	22.5 Figure 3	27.5 Figure 3	
Lead wire diameter	d	0.5 – 0.6	0.6	0.6 – 0.8	0.8	0.8	±0.05
Taping lead space	P	12.7	25.4	25.4	38.1	38.1	±1
Feed hole lead space *	P <sub>0</sub>	12.7	12.7	12.7	12.7	12.7	±0.2 **
Centering of the lead wire	P <sub>1</sub>	2.6	7.7	5.2	7.8	5.3	±0.7
Centering of the body	P <sub>2</sub>	6.35	12.7	12.7	19.05	19.05	±1.3
Lead spacing ***	F	7.5	10.0	15.0	22.5	27.5	+0.6/-0.1
Component alignment	Δh	0	0	0	0	0	±2
Component deviation	Δp	0	0	0	0	0	±1
Height of component from tape center	H <sub>0</sub> ****	18.5	18.5	18.5	18.5	18.5	±0.5
Carrier tape width	W	18	18	18	18	18	+1/-0.5
Hold down tape width	W <sub>0</sub>	6	9	10	10	10	Minimum
Hole position	W <sub>1</sub>	9	9	9	9	9	±0.5
Hold down tape position	W <sub>2</sub>	3	3	3	3	3	Maximum
Feed hole diameter	D <sub>0</sub>	4	4	4	4	4	±0.2
Total tape thickness	t	0.7	0.7	0.7	0.7	0.7	±0.2

\* Available also 15 mm.

\*\* Maximum 1 mm on 20 lead spacing.

\*\*\* 15 mm and 10 mm taped to 7.5 mm (crimped leads) available upon request.

\*\*\*\* H<sub>0</sub> = 16.5 mm is available upon request.

## Lead Taping & Packaging (IEC 60286-2) cont.

### Ammo Specifications

Dimensions (mm)		
H	W	T
360	340	59

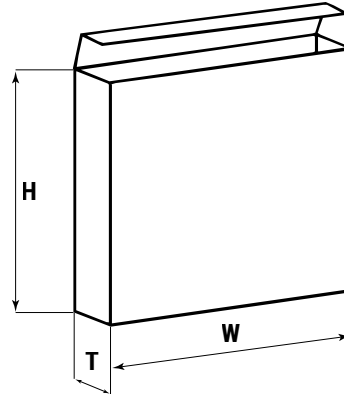

### Reel Specifications

Dimensions (mm)		
D	H	W
355	30	55 Maximum
500	25	

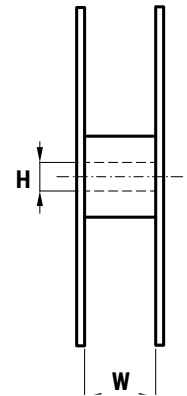
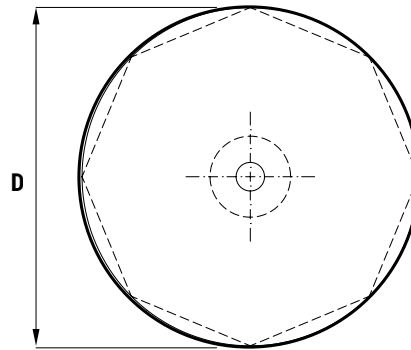



## KEMET Electronics Corporation Sales Offices

For a complete list of our global sales offices, please visit [www.kemet.com/sales](http://www.kemet.com/sales).

---

### Disclaimer

YAGEO Corporation and its affiliates do not recommend the use of commercial or automotive grade products for high reliability applications or manned space flight.

All product specifications, statements, information and data (collectively, the "Information") in this datasheet are subject to change. The customer is responsible for checking and verifying the extent to which the Information contained in this publication is applicable to an order at the time the order is placed. All Information given herein is believed to be accurate and reliable, but it is presented without guarantee, warranty, or responsibility of any kind, expressed or implied.

Statements of suitability for certain applications are based on KEMET Electronics Corporation's ("KEMET") knowledge of typical operating conditions for such applications, but are not intended to constitute – and KEMET specifically disclaims – any warranty concerning suitability for a specific customer application or use. The Information is intended for use only by customers who have the requisite experience and capability to determine the correct products for their application. Any technical advice inferred from this Information or otherwise provided by KEMET with reference to the use of KEMET's products is given gratis, and KEMET assumes no obligation or liability for the advice given or results obtained.

Although KEMET designs and manufactures its products to the most stringent quality and safety standards, given the current state of the art, isolated component failures may still occur. Accordingly, customer applications which require a high degree of reliability or safety should employ suitable designs or other safeguards (such as installation of protective circuitry or redundancies) in order to ensure that the failure of an electrical component does not result in a risk of personal injury or property damage.

Although all product-related warnings, cautions and notes must be observed, the customer should not assume that all safety measures are indicated or that other measures may not be required.

Additional information about production site flexibility can be found [here](#)

*KEMET is a registered trademark of KEMET Electronics Corporation.*