

# HCZ120N80M1A

## SiC Automotive Silicon Carbide Power MOSFET

1200 V, 30 A, 80 mΩ

### Features

- High switching speed with a low gate charge
- Fast intrinsic diode with low reverse recovery
- Robust Avalanche Capability
- 100% Avalanche Tested
- Pb-free, Halogen Free, and RoHS Compliant
- AEC Q101 Qualified

$BV_{DSS, T_C=25^\circ C}$	$I_D, T_C=25^\circ C$	$R_{DS(on), typ}$	$Q_{g, typ}$
1200 V	30 A	80 mΩ	52 nC

### Benefits

- System efficiency improvement
- Higher frequency applicability
- Increased power density
- Reduced cooling effort

### Applications

- xEV
- Solar inverter
- EV charging station
- UPS
- Industrial power supply

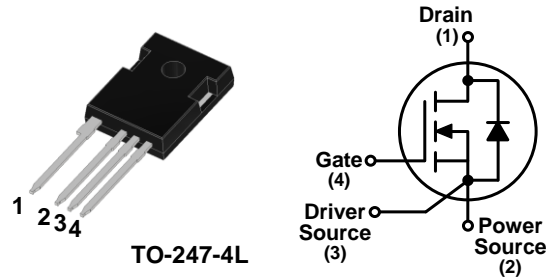

### Absolute Maximum Ratings ( $T_C = 25^\circ C$ unless otherwise noted)

Symbol	Parameter	Value	Unit
$V_{DSS}$	Drain to Source Voltage	1200	V
$V_{GS}$	Gate to Source Voltage (DC)	-10 / +22	V
$V_{GSop}$	Recommended Operation Value	-5 / +18	V
$I_D$	Drain Current	Continuous ( $T_C = 25^\circ C$ )	30
		Continuous ( $T_C = 100^\circ C$ )	21
$I_{DM}$	Drain Current	Pulsed (Note1)	80
$P_D$	Power Dissipation	( $T_C = 25^\circ C$ )	150
		Derate Above $25^\circ C$	1.00
$T_J, T_{STG}$	Operating and Storage Temperature Range	-55 to 175	$^\circ C$
$T_L$	Maximum Lead Temperature for Soldering, 1/8" from Case for 10 Seconds	260	$^\circ C$

※Note 1 : Limited by maximum junction temperature.

### Thermal Characteristics

Symbol	Parameter	Value	Unit
$R_{\theta JC}$	Thermal Resistance, Junction to Case, Max.	1.00	$^\circ C/W$
$R_{\theta JA}$	Thermal Resistance, Junction to Ambient, Max.	40	

### Package Marking and Ordering Information

Part Number	Top Marking	Package	Packing Method	Quantity
HCZ120N80M1A	HCZ120N80M1A	TO-247-4L	Tube	30 units

**Electrical Characteristics** ( $T_C = 25^\circ\text{C}$  unless otherwise noted)

Symbol	Parameter	Test Conditions	Min	Typ	Max	Unit
<b>Off Characteristics</b>						
$BV_{DSS}$	Drain to Source Breakdown Voltage	$V_{GS} = 0\text{ V}, I_D = 1\text{ mA}$	1200			V
$I_{DSS}$	Zero Gate Voltage Drain Current	$V_{DS} = 1200\text{ V}, V_{GS} = 0\text{ V}$		1	100	$\mu\text{A}$
		$V_{DS} = 1200\text{ V}, V_{GS} = 0\text{ V}, T_J = 175^\circ\text{C}$		5		
$I_{GSS}$	Gate-Source Leakage Current	$V_{GS} = +22\text{ V}, V_{DS} = 0\text{ V}$			+100	$\text{nA}$
		$V_{GS} = -10\text{ V}, V_{DS} = 0\text{ V}$			-100	
<b>On Characteristics</b>						
$V_{GS(th)}$	Gate Threshold Voltage	$V_{GS} = V_{DS}, I_D = 5.0\text{ mA}$ (tested after $V_{GS} = 22\text{ V}, 1\text{ ms pulse}$ )	2.0	3.0	4.5	V
$R_{DS(on)}$	Static Drain to Source On Resistance	$V_{GS} = 18\text{ V}, I_D = 15\text{ A}$		80	110	$\text{m}\Omega$
		$V_{GS} = 18\text{ V}, I_D = 15\text{ A}, T_J = 175^\circ\text{C}$		128		
$g_{fs}$	Transconductance	$V_{DS} = 20\text{ V}, I_D = 15\text{ A}$		11.4		S
<b>Dynamic Characteristics</b>						
$C_{iss}$	Input Capacitance	$V_{DS} = 800\text{ V}, V_{GS} = 0\text{ V}, f = 250\text{ kHz}$		880		$\text{pF}$
$C_{oss}$	Output Capacitance			64		
$C_{rss}$	Reverse Capacitance			5		
$E_{oss}$	Stored Energy in Output Capacitance	$V_{DS} = 0\text{ V to } 800\text{ V}, V_{GS} = 0\text{ V}$		26		$\mu\text{J}$
$C_{o(er)}$	Energy Related Output Capacitance			80		$\text{pF}$
$C_{o(tr)}$	Time Related Output Capacitance			142		
$Q_{g(tot)}$	Total Gate Charge	$V_{DS} = 800\text{ V}, I_D = 15\text{ A},$ $V_{GS} = -5\text{ V} / 18\text{ V},$ Inductive load		52		$\text{nC}$
$Q_{gs}$	Gate to Source Charge			13		
$Q_{gd}$	Gate to Drain "Miller" Charge			17		
$R_G$	Internal Gate Resistance	$f = 1\text{ MHz}$		4.0		$\Omega$
<b>Switching Characteristics</b>						
$t_{d(on)}$	Turn-On Delay Time	$V_{DS} = 800\text{ V}, I_D = 15\text{ A},$ $V_{GS} = -5\text{ V} / 18\text{ V}, R_G = 2\ \Omega,$ FWD : HCH120S10D1, Inductive load		14		$\text{ns}$
$t_r$	Turn-On Rise Time			9		
$t_{d(off)}$	Turn-Off Delay Time			24		
$t_f$	Turn-Off Fall Time			8		$\mu\text{J}$
$E_{on}$	Turn-on Switching Energy			75		
$E_{off}$	Turn-off Switching Energy			47		
$E_{tot}$	Total Switching Energy			122		
<b>Source-Drain Diode Characteristics</b>						
$I_S$	Maximum Continuous Diode Forward Current			30		A
$I_{SM}$	Maximum Pulsed Diode Forward Current			80		
$V_{SD}$	Diode Forward Voltage	$V_{GS} = -5\text{ V}, I_{SD} = 15\text{ A}$		4.1		V
$t_{rr}$	Reverse Recovery Time	$V_{DD} = 800\text{ V}, I_{SD} = 15\text{ A},$ $di_F/dt = 3000\text{ A}/\mu\text{s},$ Includes $Q_{oss}$		12		ns
$Q_{rr}$	Reverse Recovery Charge			122		nC

Typical Performance Characteristics

Figure 1. On-Region Characteristics  $T_J = -40^\circ\text{C}$

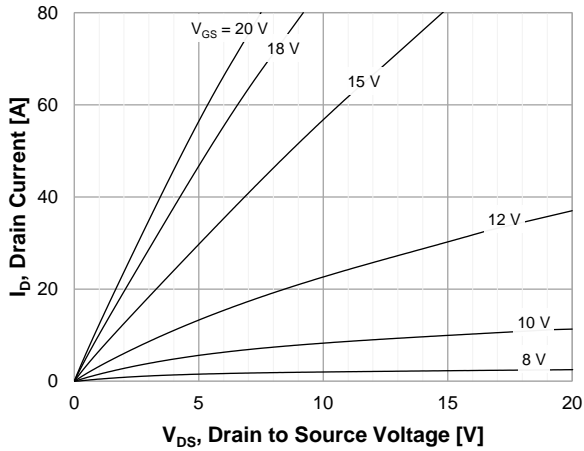

Figure 2. On-Region Characteristics  $T_J = 25^\circ\text{C}$

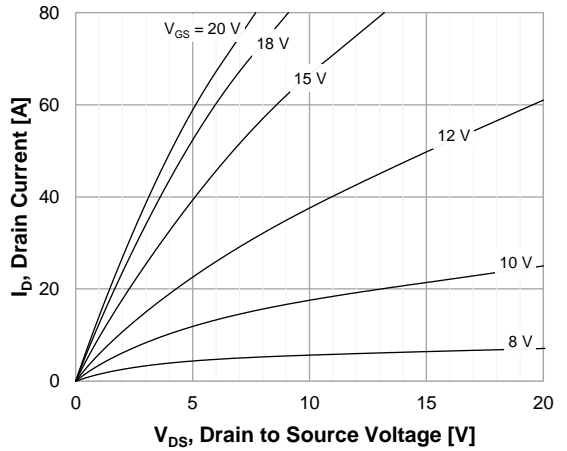

Figure 3. On-Region Characteristics  $T_J = 175^\circ\text{C}$

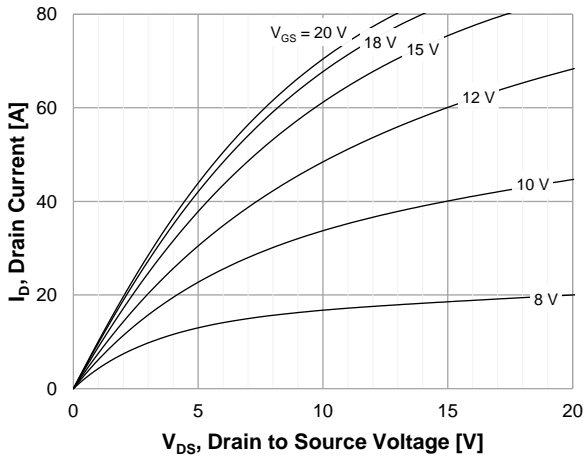

Figure 4. Normalized On-Resistance Characteristics vs. Temperature

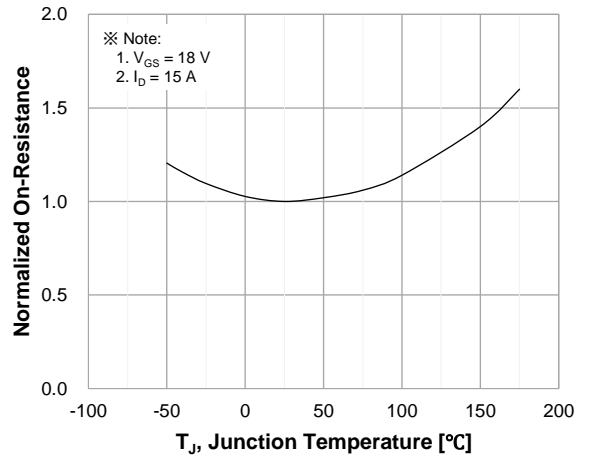

Figure 5. Transfer Characteristics

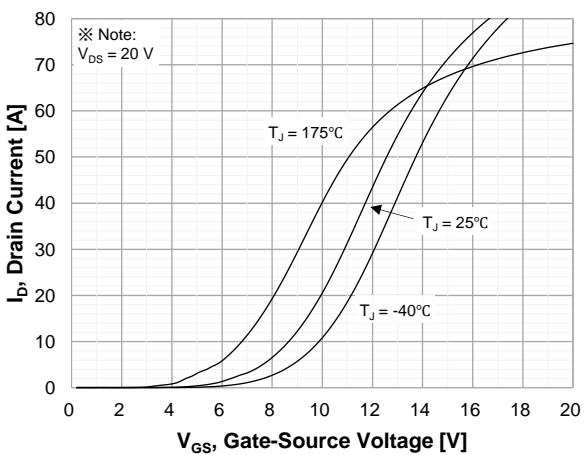
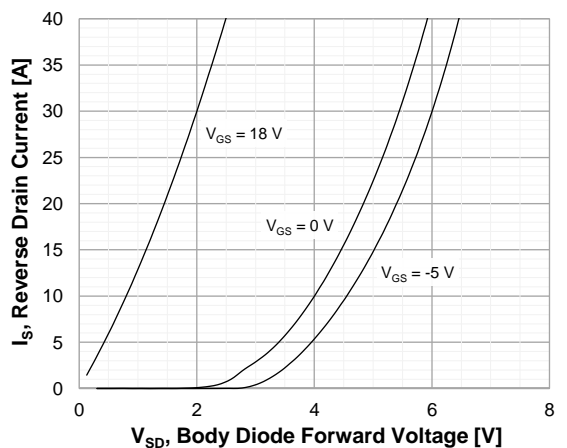

Figure 6. Diode Forward Voltage Characteristics vs. Source-Drain Current  $T_J = -40^\circ\text{C}$



Typical Performance Characteristics

Figure 7. Diode Forward Voltage Characteristics vs. Source-Drain Current  $T_J = 25^\circ\text{C}$

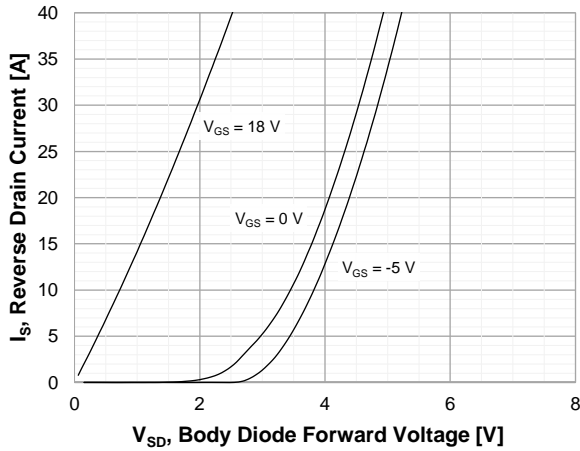

Figure 8. Diode Forward Voltage Characteristics vs. Source-Drain Current  $T_J = 175^\circ\text{C}$

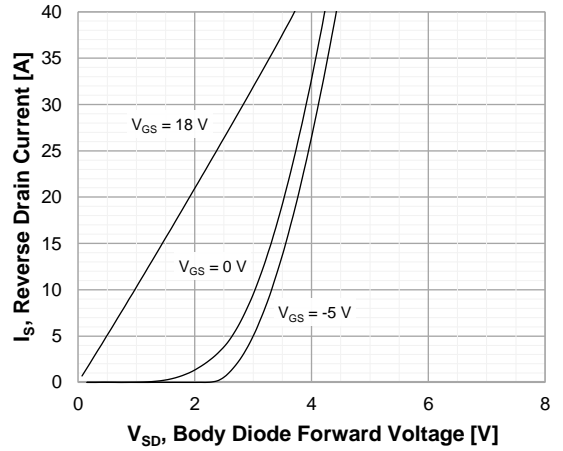

Figure 9. Threshold Voltage vs. Temperature

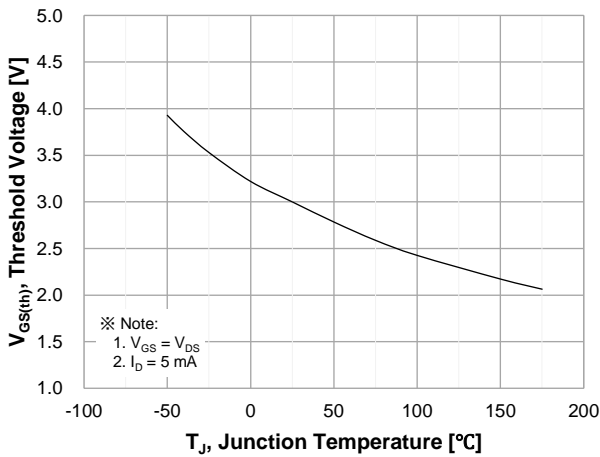

Figure 10. Gate Charge Characteristics

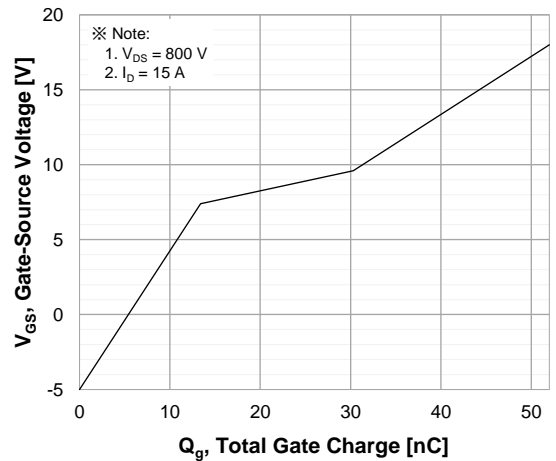

Figure 11. Stored Energy in Output Capacitance

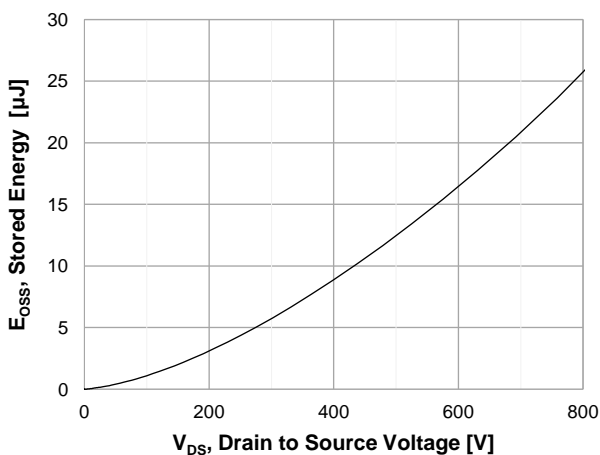
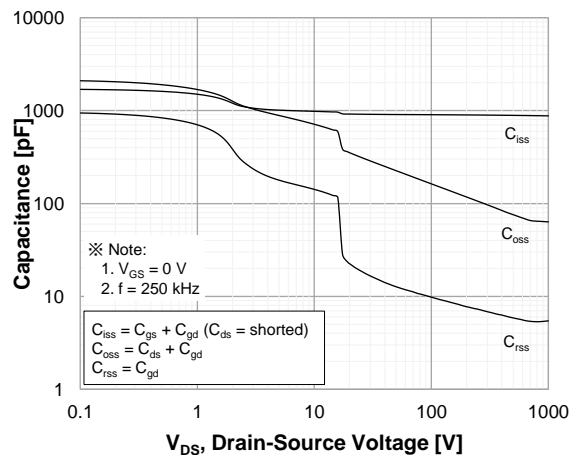

Figure 12. Capacitance Characteristics



Typical Performance Characteristics

Figure 13. Continuous Drain Current Derating vs. Case Temperature

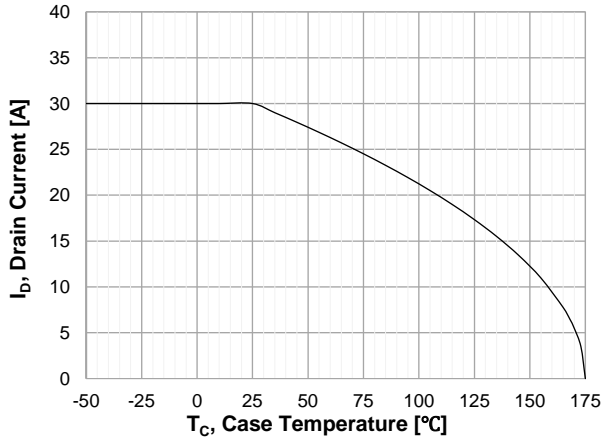

Figure 14. Maximum Power Dissipation Derating vs. Case Temperature

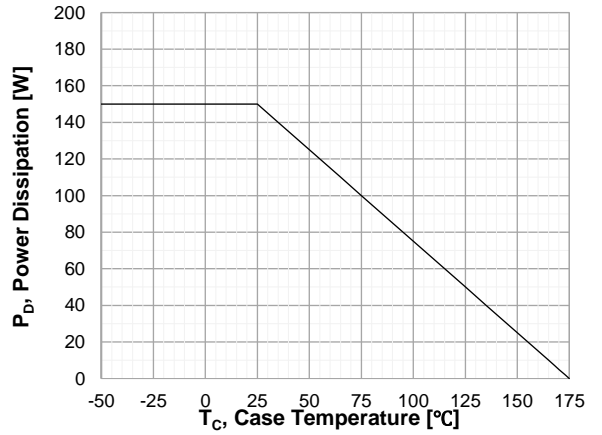

Figure 15. Typ. Switching Losses vs. Drain Current

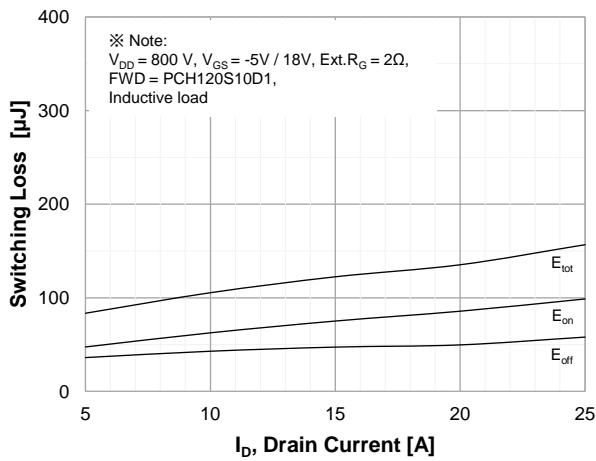

Figure 16. Typ. Switching Losses vs. Gate Resistance

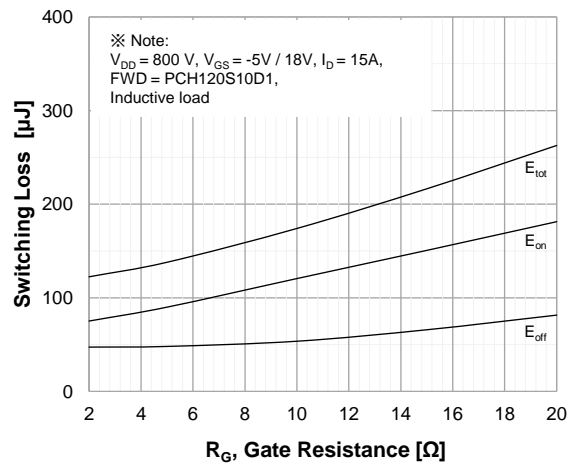

Figure 17. Typ. Switching Losses vs. Drain Current

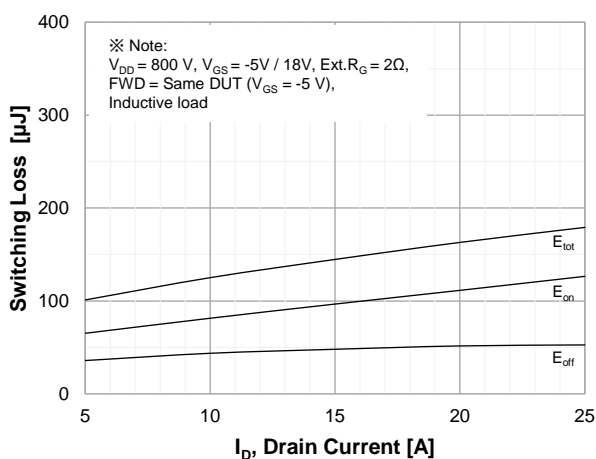
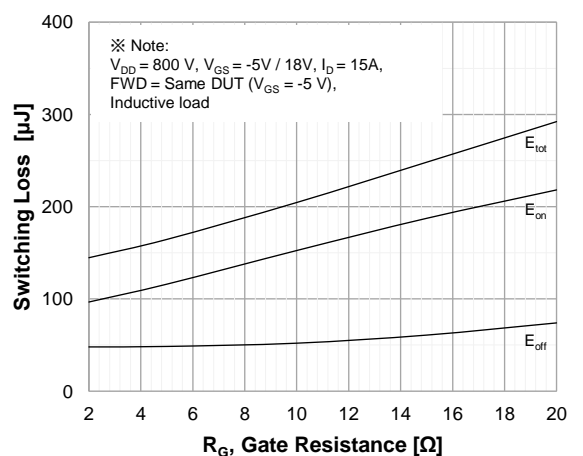

Figure 18. Typ. Switching Losses vs. Gate Resistance



Typical Performance Characteristics

Figure 19. Maximum Safe Operating Area

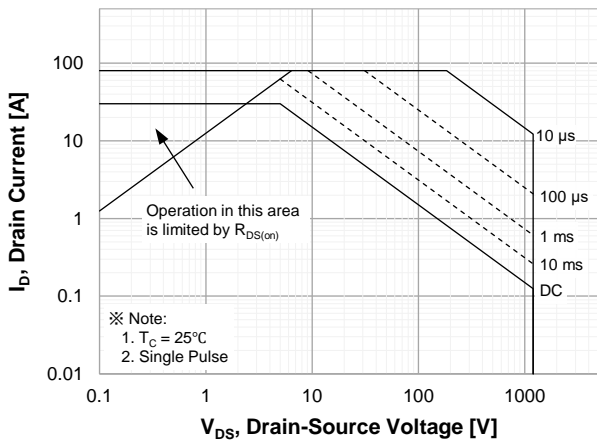

Figure 20. Transient Thermal Response Curve

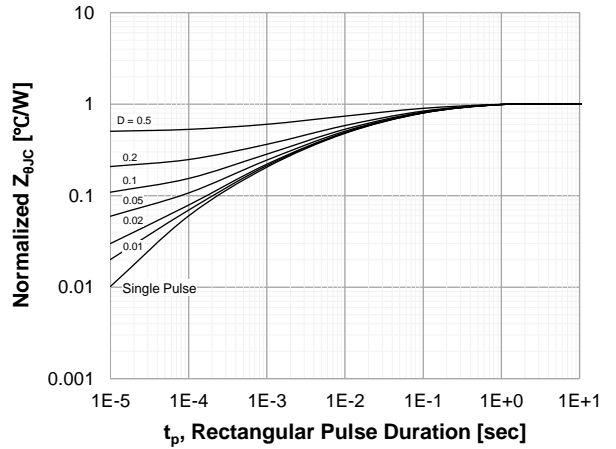

Figure 21. Inductive Load Switching Test Circuit and Waveforms

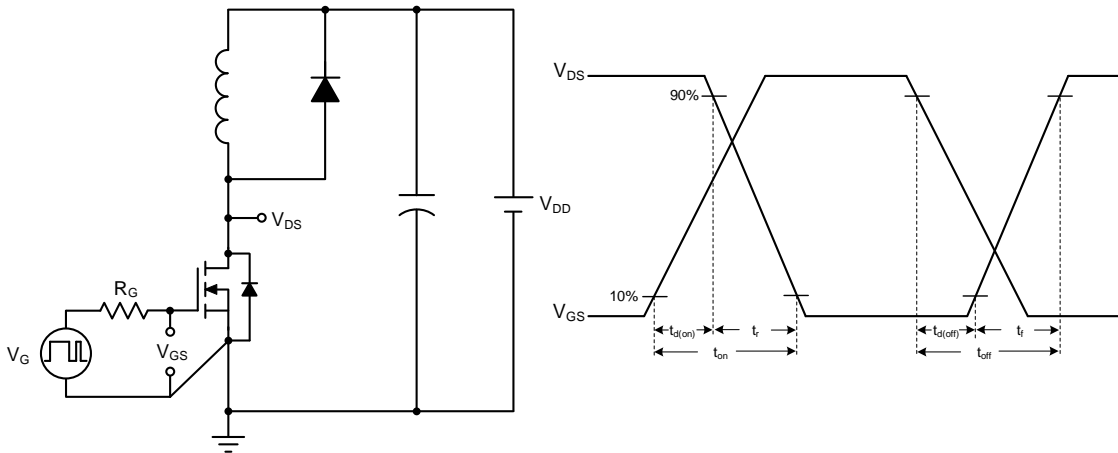
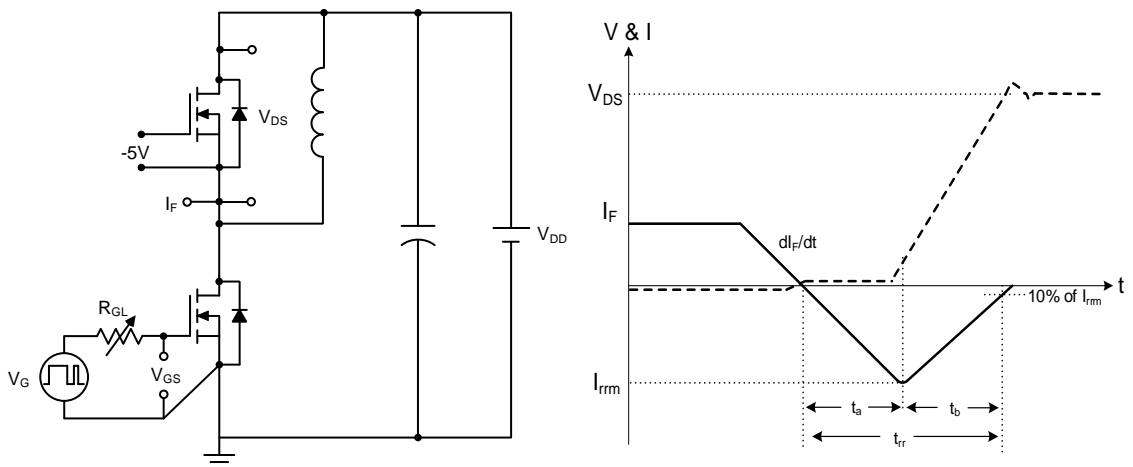
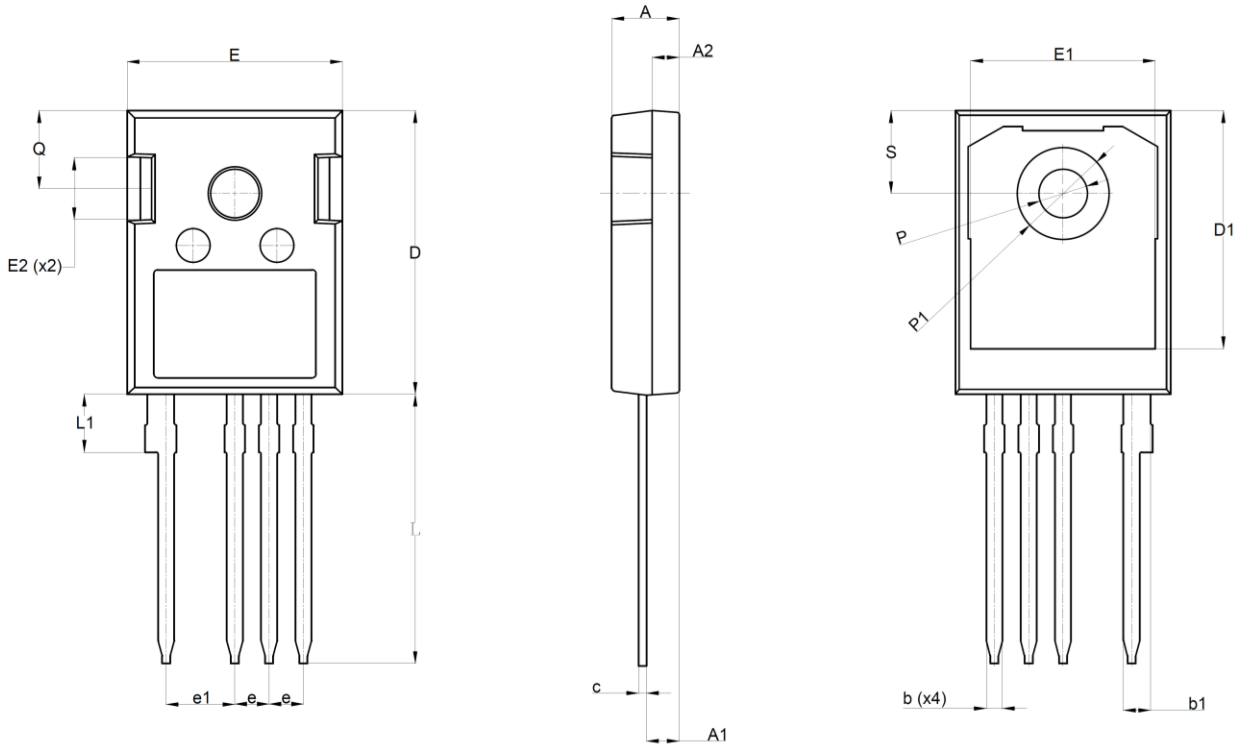

Figure 22. Peak Diode Recovery  $dv/dt$  Test Circuit and Waveforms



Package Outlines  
**TO-247-4L**



SYMBOL	Common		
	DIMENSIONS MILLIMETER		
	MIN.	NOM.	MAX.
A	4.80	5.00	5.20
A1	2.29	2.42	2.54
A2	1.90	2.00	2.10
b	1.10	1.20	1.30
b1	1.86	2.01	2.15
c	0.50	0.60	0.70
D	20.90	21.00	21.10
D1	17.43	17.63	17.83
E	15.75	15.94	16.13
E1	13.46	13.66	13.86
E2	4.32	4.58	4.83
e	2.54 BSC.		
e1	5.08 BSC.		
L	19.80	19.95	20.10
L1	-	-	4.30
P	3.56	3.61	3.66
P1	6.75	6.80	6.85
Q	5.38	5.79	6.20
S	6.15 BSC.		