

Part Numbering System

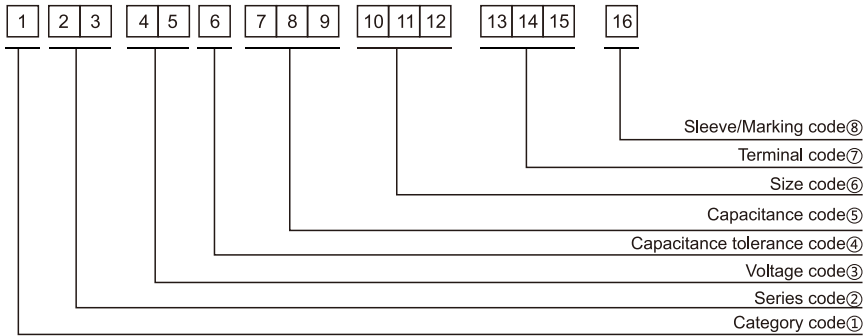

① Category code

Type	Code
	1
Electrolytic Capacitor	E
Conductive Polymer	S

② Series code

Series name	Code	
	2	3
WH	W	H
CD11GE	G	E
CD11GES	G	X
CD11GAS	G	W
CD11GHS	G	S
NR	N	R
PZ	P	Z

③ Voltage code

WV (V _{dc})	Code	
	4	5
2.5	0	E
3	0	D
4	0	G
6.3	0	J
6.8	0	C
7	0	Q
7.5	0	A
10	1	A
12	1	T
16	1	C
25	1	E
35	1	V
40	1	G
50	1	H
63	1	J
80	1	B
100	1	K
120	2	B
160	2	C
180	2	L
200	2	D
220	2	N
250	2	E
315	2	F
350	2	V
380	2	P
400	2	G
420	2	T
450	2	W
500	2	H
550	2	J
600	2	K

④ Capacitance tolerance code

Tol. (%)	Code
	6
-10~+10	K
-20~+20	M
-10~+30	Q
-10~+20	V
0~+20	A
-5~+20	C
-10~-20	B
-5~+5	D
0~+10	E
-5~-20	F
-15~+5	N

⑤ Capacitance code

Cap (μF)	Code		
	7	8	9
0.10	R	1	0
0.22	R	2	2
0.33	R	3	3
0.47	R	4	7
0.68	R	6	8
1	0	1	0
2.2	2	R	2
3.3	3	R	3
4.7	4	R	7
6.8	6	R	8
10	1	0	0
22	2	2	0
33	3	3	0
47	4	7	0
68	6	8	0
100	1	0	1
220	2	2	1
330	3	3	1
470	4	7	1
680	6	8	1
1000	1	0	2
2200	2	2	2
3300	3	3	2
4700	4	7	2
6800	6	8	2
10000	1	0	3
22000	2	2	3
33000	3	3	3
68000	6	8	3

⑥ Size code

ΦD (mm)	Code
10	
4	C
5	D
6.3	E
8	F
10	G
11	H
12	J
12.5	W
13	K
14	X
16	L
18	M
19	Z
20	N
22	O
25	P
30	Q
35	R
40	Y
51.6	S
64.3	T
76.9	U
91	V
100	A

L (mm)	Code	
	11	12
5	0	5
7	0	7
11	1	1
12	1	2
16	1	6
20	2	0
25	2	5
30	3	0
35	3	5
40	4	0
46	4	6
50	5	0
60	6	0
80	8	0
100	A	0
115	B	5
120	C	0
130	D	0
140	E	0
160	G	0
200	K	0
220	M	0
236	N	6
250	P	0

⑦ Terminal code

Specification	Code	Size	
	13	14	15
Bulk packing	O	-	-
Taping (SMD Type)	D	0	0
Φ4~8 Taping F=5.0mm	P	5	0
Φ10~12.5 Taping F=5.0mm	B	5	0
Lead Cut L=3.5mm	C	3	5
Lead Cut L=11.0mm	C	B	0
Lead Forming & Cut L=4.5mm	F	-	-
Kink & Cut L=4.5mm	J	-	-
Snap-in type Terminal 4.0mm in length	K	-	-
Three Terminals	T	-	-
Ring clip mounting standard design	A	0	0
Ring clip mounting special design	S	-	-

⑧ Sleeve/Marking code

Sleeve/Marking	Code
	16
PVC	C
PET	T
Dark blue	B
Bright red	R
Sky-blue	S
Light blue	T
Pink	Z
Black	H
Purple-blue	V
Red	O

Lead Forming
Taping Specifications

Fig.1 code: X



Fig.2 code: B



Fig.3 code: B

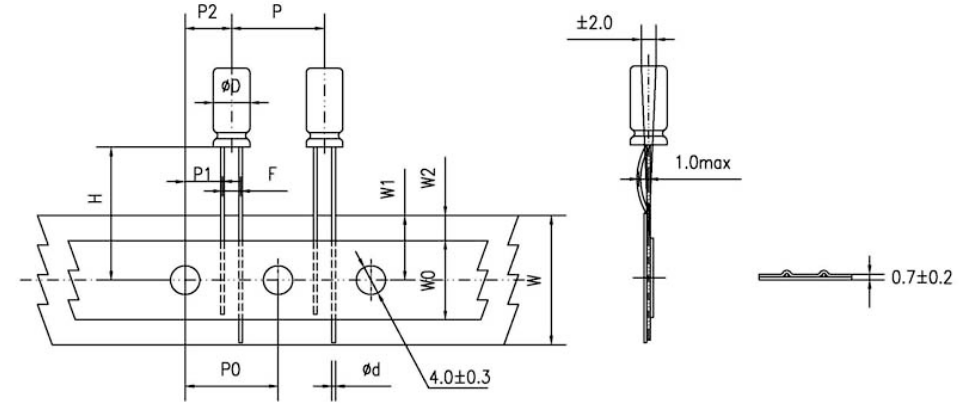

Fig.4 code: P



Lead Forming

Specification Fig.1 & Fig.2 & Fig.3

Items	Symbol	Case size										Tolerance		
		4*5 4*7		5*5 5*7		5*11		6.3*5	6.3*7 6.3*9	6.3*11 6.3*12	8*5/7 8*9/11 8*11.5 8*12		8*16 8*20	10*9/12 10*12.5 10*13/16 10*20/25
Pin Code		X	B	X	B	X	B	B	B	B	B	B	B	
Lead wire diameter	Φd	0.45		0.45		0.5		0.45	0.5	0.5	0.45/0.5	0.6	0.6	±0.05
Pitch of body	P	12.7		12.7		12.7		12.7	12.7	12.7	12.7	12.7	12.7	±1.0
Feed hole pitch	P0	12.7		12.7		12.7		12.7	12.7	12.7	12.7	12.7	12.7	±0.2
Distance from hole center to lead	P1	5.1	5.6	5.1	5.35	5.1	5.35	5.1	5.1	5.1	4.6	4.6	3.85	±0.7
Distance from feed hole center to body center	P2	6.35		6.35		6.35		6.35	6.35	6.35	6.35	6.35	6.35	±1.0
Lead-to-lead distance	F	2.5	1.5	2.5	2.0	2.5	2.0	2.5	2.5	2.5	3.5	3.5	5.0	±0.5
Height of body from tape center	H	18.5		18.5		18.5		18.5	18.5	18.5	18.5	18.5	18.5	±0.75
Base tape width	W	18.0		18.0		18.0		18.0	18.0	18.0	18.0	18.0	18.0	±0.5
Adhesive tape width	W0	6.0		6.0		6.0		6.0	6.0	8.0	8.0	8.0	11.0	min
Hole position	W1	9.0		9.0		9.0		9.0	9.0	9.0	9.0	9.0	9.0	+0.75 -0.5
Hole down tape position	W2	3.0		3.0		3.0		3.0	3.0	3.0	3.0	3.0	3.0	max

Specification Fig.4

Items	Symbol	Case size									Tolerance
		4*5 4*7	5*5	5*7	5*11	6.3*5	6.3*7 6.3*9	6.3*11 6.3*12	8*5/7 8*9/11 8*11.5/12	8*16 8*20	
Pin Code		P	P	P	P	P	P	P	P	P	
Lead wire diameter	Φd	0.45	0.45	0.45	0.5	0.45	0.5	0.5	0.45/0.5	0.6	±0.05
Pitch of body	P	12.7	12.7	12.7	12.7	12.7	12.7	12.7	12.7	12.7	±1.0
Feed hole pitch	P0	12.7	12.7	12.7	12.7	12.7	12.7	12.7	12.7	12.7	±0.2
Distance from hole center to lead	P1	3.85	3.85	3.85	3.85	3.85	3.85	3.85	3.85	3.85	±0.7
Distance from feed hole center to body center	P2	6.35	6.35	6.35	6.35	6.35	6.35	6.35	6.35	6.35	±1.0
Lead-to-lead distance	F	1.5	2.0	2.0	2.0	2.5	2.5	2.5	3.5	3.5	±0.5
Lead to lead distance	F1	5.0	5.0	5.0	5.0	5.0	5.0	5.0	5.0	5.0	+0.8 -0.2
Height of body from tape center	H	18.5	18.5	18.5	18.5	18.5	18.5	18.5	18.5	18.5	±0.75
Lead wire clinch height	H0	16.0	16.0	16.0	16.0	16.0	16.0	16.0	16.0	16.0	±0.5
Base tape width	W	18.0	18.0	18.0	18.0	18.0	18.0	18.0	18.0	18.0	±0.5
Adhesive tape width	W0	6.0	6.0	6.0	6.0	6.0	6.0	8.0	8.0	8.0	min
Hole position	W1	9.0	9.0	9.0	9.0	9.0	9.0	9.0	9.0	9.0	+0.75 -0.5
Hole down tape position	W2	3.0	3.0	3.0	3.0	3.0	3.0	3.0	3.0	3.0	max

Lead Forming

Lead Forming & Cut

Code:C
RANGE: $\Phi 4\sim\Phi 18$



Code:F
RANGE: $\Phi 4\sim\Phi 8$



ΦD	F	L	ΦD	F	L
4	1.5	3.0~12.0	4	5.0	3.5, 4.5, 5.0, 7.0
5	2.0	3.0~12.0	5	5.0	3.5, 4.5, 5.0, 7.0
6.3	2.5	3.0~12.0	6.3	5.0	3.5, 4.5, 5.0, 7.0
8	3.5	3.0~12.0	8	5.0	3.5, 4.5, 5.0, 7.0
10	5.0	3.0~12.0	-	-	-
12.5	5.0	3.0~12.0	-	-	-
16	7.5	3.0~12.0	-	-	-
18	7.5	3.0~12.0	-	-	-

Code:J
RANGE: $\Phi 10\sim\Phi 18$



ΦD	F	L
10	5.0	4.0, 4.5, 5.0
12.5	5.0	4.0, 4.5, 5.0
16	7.5	4.0, 4.5, 5.0
18	7.5	4.0, 4.5, 5.0

Solering Recommendation

■ Flow Soldering(Radial Lead Type)

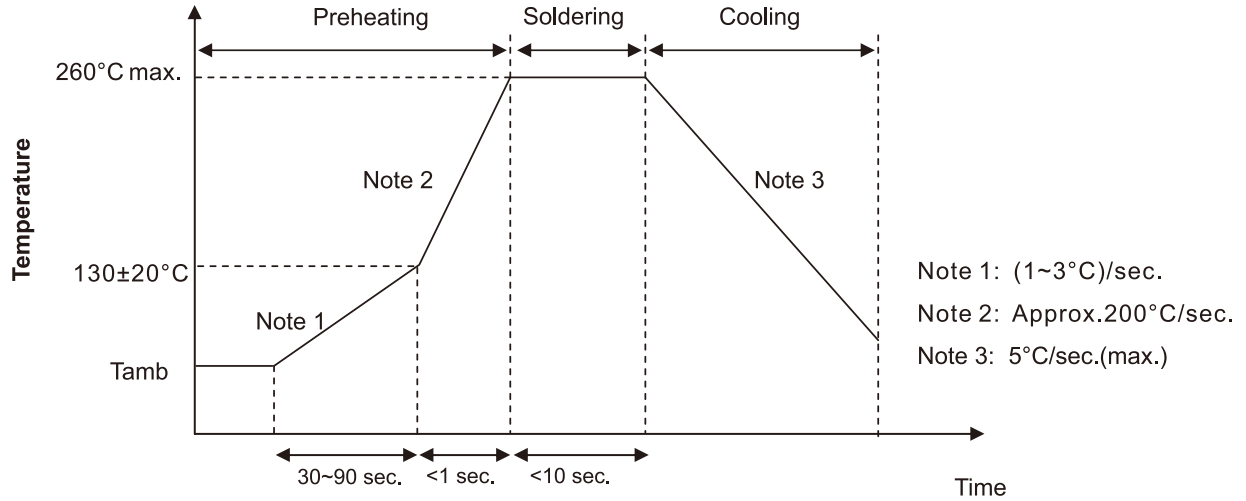

■ Reflow Soldering

- (For Polymer SMD Type)

Recommended Reflow Profile

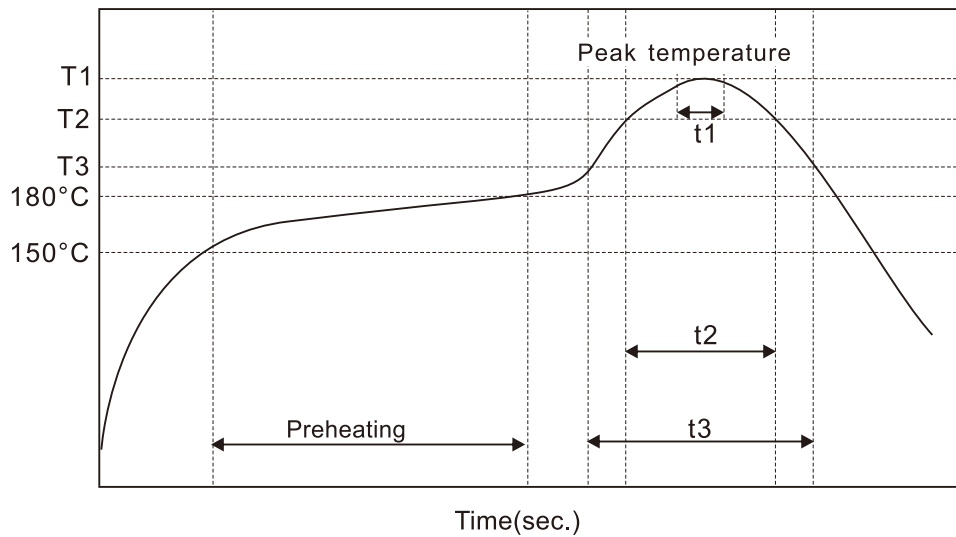

Item	Preheating	T1(°C)	T2(°C)	T3(°C)	t1(sec.)	t2(sec.)	t3(sec.)	Reflow cycle
Condition 1	150°C to 180°C Within 90sec.	≤260	230	200	≤10	≤40	≤60	1
Condition 2		≤250	230	200	≤10	≤40	≤60	2

● (For Liquid SMD Type)

Case size: $\Phi 6.3$ – $\Phi 10$ mm:

- Temperature at surface of capacitor shall not exceed $T^{\circ}\text{C}$.
- The duration for over 200°C temperature and $T_1^{\circ}\text{C}$ at surface of capacitor shall not exceed t and t_1 seconds, respectively.
- Preheat shall be done at 100°C to 200°C and for Maximum 180 seconds.

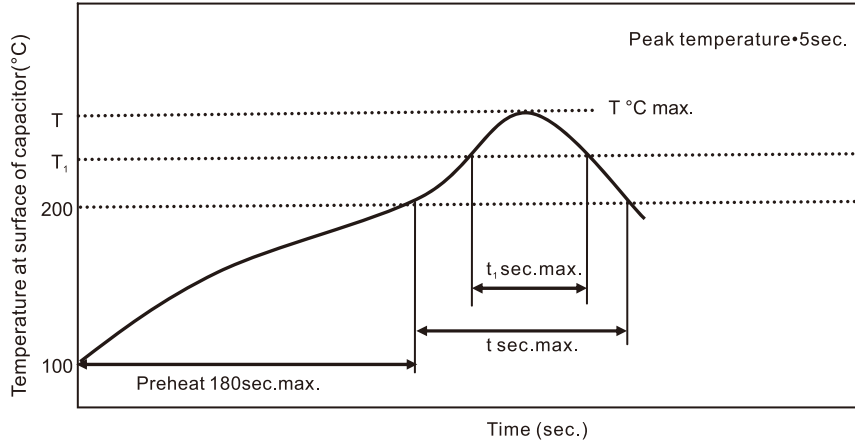

Case size (mm)	$T(^{\circ}\text{C})$ ①	$T_1(^{\circ}\text{C})$	$t(\text{sec.})$ ②	$t_1(\text{sec.})$ ③	Reflow cycle
$\Phi 6.3$	250	230	90	40	1
$\Phi 8$	240	230	90	30	1
$\Phi 10$	235	230	60	30	1

- ① Peak temperature
- ② The duration over 200°C (max.)
- ③ The duration over $T_1^{\circ}\text{C}$
- Please contact us if capacitors are subject to the conditions other than the allowable range of reflow.

Case size: $\Phi 12.5$ – $\Phi 18$ mm:

- Temperature at surface of capacitor shall not exceed $T^{\circ}\text{C}$.
- The duration for over 200°C temperature and $T_1^{\circ}\text{C}$ at surface of capacitor shall not exceed t and t_1 seconds, respectively.
- Preheat shall be done at 100°C to 180°C and for Maximum 150 seconds.

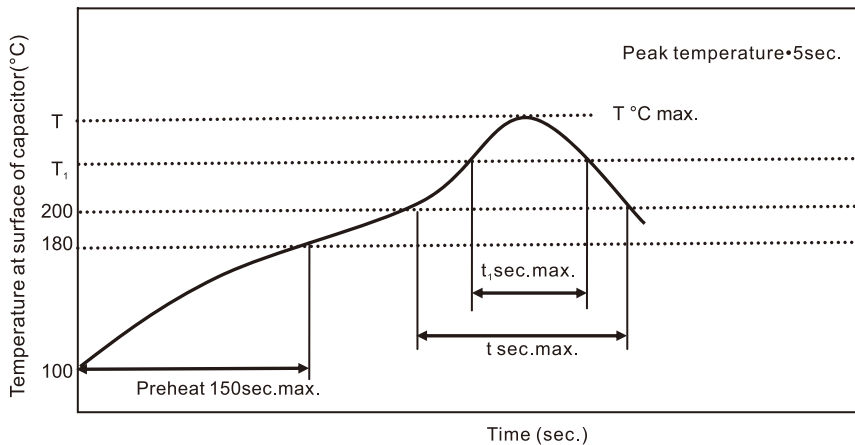

Case size (mm)	$T(^{\circ}\text{C})$ ①	$T_1(^{\circ}\text{C})$	$t(\text{sec.})$ ②	$t_1(\text{sec.})$ ③	Reflow cycle
$\Phi 12.5$ – $\Phi 18$	240	230	60	30	1

- ① Peak temperature
- ② The duration over 200°C (max.)
- ③ The duration over $T_1^{\circ}\text{C}$
- Please contact us if capacitors are subject to the conditions other than the allowable range of reflow.

WH series

- Standard series for general purpose
- Wide temperature range from -40 °C to +105 °C
- Endurance: +105 °C 2,000 hours
- RoHS Compliant



SPECIFICATIONS

Items	Characteristics												
Category Temperature Range	-40~+105 °C (6.3~100 V _{dc})						-25~+105°C(160~500 V _{dc})						
Rated Voltage Range	6.3~500 V _{dc}												
Capacitance Tolerance	±20%(M) (at 20°C, 120Hz)												
Leakage Current	6.3~100 V _{dc}						160~500 V _{dc}						Where, I:Max. leakage current (µA), C:Nominal capacitance (µF), V: Rated voltage (V) (at 20°C)
	I≤0.03CV or 4µA (at 1 minute) I≤0.01CV or 3µA (at 2 minutes) Whichever is greater						CV		After 1 minute		After 5 minutes		
							CV≤1,000		I≤0.1CV+40µA		I≤0.03CV+15µA		
Dissipation Factor (tanδ)	Rated Voltage(V _{dc})	6.3	10	16	25	35	50	63	100	160~250	350~400	450	500
	tanδ (max.)	0.26	0.19	0.16	0.14	0.12	0.10	0.09	0.08	0.20	0.24	0.24	0.24
	When nominal capacitance exceeds 1,000µF, add 0.02 to the value above for each 1,000µF increase. (at 20°C, 120Hz)												
Low Temperature Characteristics (Max. Impedance Ratio)	Rated Voltage(V _{dc})	6.3	10	16	25	35	50	63	100	160~250	350~400	450	500
	Z(-25°C)/Z(+20°C)	5	4	3	2				3		6	6	8
	Z(-40°C)/Z(+20°C)	12	10	8	5	4	3		-		-	-	-
Endurance	The following specifications shall be satisfied when the capacitors are restored to 20°C after DC voltage plus the rated ripple current is applied for 2,000 hours at 105°C.												
	Capacitance Change	≤±20% of the initial value											
	D.F. (tanδ)	≤200% of the initial specified value											
	Leakage Current	≤The initial specified value											
Shelf Life	The following specifications shall be satisfied when the capacitors are restored to 20°C after exposing them for 1,000 hours at 105°C without voltage applied.												
	Capacitance Change	≤±20% of the initial value											
	D.F. (tanδ)	≤200% of the initial specified value											
	Leakage Current	≤200% of the initial specified value											

DIMENSIONS[mm]

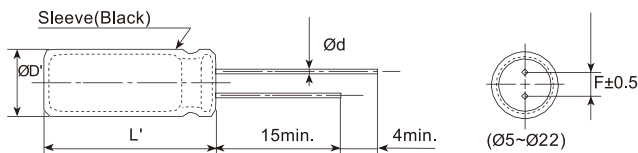

ØD	5	6.3	8	10	12.5	16	18	22
Ød	0.5	0.5	0.5	0.6	0.6	0.8	0.8	0.8
F	2.0	2.5	3.5	5.0	5.0	7.5	7.5	10.0
ØD'	ØD+0.5max.							
L'	L+2max.							

PART NUMBERING SYSTEM

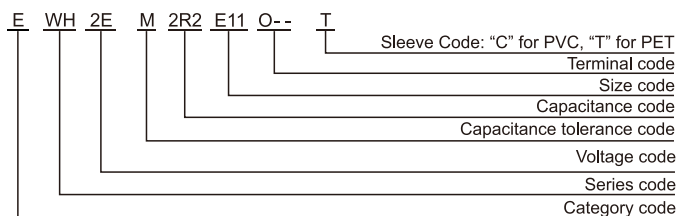

RATED RIPPLE CURRENT MULTIPLIERS

Frequency correction factor for ripple current

Cap.(µF) \ Freq.(Hz)	50	120	300	1k	10k	100k
Cap.<10	0.65	1.00	1.35	1.75	2.30	2.50
10≤Cap.<100	0.75	1.00	1.25	1.50	1.75	1.80
100≤Cap.≤1000	0.80	1.00	1.15	1.30	1.40	1.50
Cap.>1000	0.85	1.00	1.03	1.05	1.08	1.08

The endurance of capacitors is shortened with internal heating produced by ripple current at the rate of halving the lifetime with every 5 °C rise. When long life performance is required in actual use, the rms ripple current has to be reduced.

WH series

■ STANDARD RATINGS

WV (V _{dc})	Cap (μF)	Size ΦDxL(mm)	tanδ	Rated ripple current (mA _{rms} /105°C,120Hz)
6.3(0J)	33	5*11	0.26	54
	47	5*11	0.26	64
	100	5*11	0.26	94
	220	5*11	0.26	140
	330	6.3*11	0.26	190
	470	6.3*11	0.26	230
	1000	8*12	0.26	380
	2200	10*20	0.28	710
	3300	10*20	0.30	840
	4700	12.5*20	0.32	1090
	6800	12.5*25	0.36	1350
	10000	16*25	0.44	1650
	15000	16*35	0.54	2010
	22000	18*40	0.68	2350
10(1A)	22	5*11	0.19	46
	33	5*11	0.19	57
	47	5*11	0.19	68
	100	5*11	0.19	100
	220	6.3*11	0.19	170
	330	6.3*11	0.19	200
	470	8*11	0.19	250
	1000	10*12.5	0.19	460
	2200	10*20	0.21	760
	3300	12.5*20	0.23	1000
	4700	12.5*25	0.25	1260
	6800	16*25	0.29	1570
	10000	16*35	0.37	1890
	15000	18*35	0.47	2180
16(1C)	10	5*11	0.16	34
	22	5*11	0.16	51
	33	5*11	0.16	63
	47	5*11	0.16	75
	100	5*11	0.16	110
	220	6.3*11	0.16	180
	330	8*11	0.16	260
	470	8*12	0.16	310
	1000	10*16	0.16	560
	2200	12.5*20	0.18	920
	3300	12.5*25	0.20	1170
	4700	16*25	0.22	1480
	6800	16*30	0.26	1780
	10000	18*35	0.34	2060
25(1E)	4.7	5*11	0.14	25
	10	5*11	0.14	36
	22	5*11	0.14	54
	33	5*11	0.14	67
	47	5*11	0.14	80
	100	6.3*11	0.14	130
	220	8*11	0.14	230
	330	8*12	0.14	310
	470	10*12.5	0.14	380
	1000	10*20	0.14	680
	2200	12.5*25	0.16	1090
	3300	16*25	0.18	1400
	4700	16*30	0.20	1710
	6800	18*35	0.24	2040

WV (V _{dc})	Cap (μF)	Size ΦDxL(mm)	tanδ	Rated ripple current (mA _{rms} /105°C,120Hz)
35(1V)	4.7	5*11	0.12	28
	10	5*11	0.12	41
	22	5*11	0.12	61
	33	5*11	0.12	75
	47	5*11	0.12	90
	100	6.3*11	0.12	150
	220	8*12	0.12	270
	330	10*12.5	0.12	350
	470	10*16	0.12	460
	1000	12.5*20	0.12	810
	2200	16*25	0.14	1260
	3300	16*35	0.16	1610
	4700	18*35	0.18	1910
	50(1H)	0.10	5*11	0.10
0.22		5*11	0.10	2.9
0.33		5*11	0.10	4.3
0.47		5*11	0.10	6.2
1.0		5*11	0.10	13
2.2		5*11	0.10	20
3.3		5*11	0.10	25
4.7		5*11	0.10	30
10		5*11	0.10	40
22		5*11	0.10	65
33		6.3*11	0.10	90
47		6.3*11	0.10	110
100		8*11	0.10	180
220		10*12.5	0.10	300
330	10*16	0.10	410	
470	10*20	0.10	530	
1000	12.5*25	0.10	950	
2200	16*35	0.12	1470	
3300	18*35	0.14	1770	
63(1J)	10	5*11	0.09	46
	22	5*11	0.09	71
	33	6.3*11	0.09	100
	47	6.3*11	0.09	120
	100	10*12.5	0.09	215
	220	10*16	0.09	335
	330	10*20	0.09	510
	470	12.5*20	0.09	640
	1000	16*25	0.09	930
	100(1K)	0.10	5*11	0.08
0.22		5*11	0.08	3.4
0.33		5*11	0.08	5.0
0.47		5*11	0.08	7.1
1.0		5*11	0.08	15
2.2		5*11	0.08	21
3.3		5*11	0.08	29
4.7		5*11	0.08	62
10		6.3*11	0.08	54
22		8*11	0.08	93
33		8*12	0.08	130
47		10*12.5	0.08	165
100		10*20	0.08	265
220		12.5*25	0.08	440

Radial Type

WH series

■ STANDARD RATINGS

WV (V _{dc})	Cap (μF)	Size ΦDxL(mm)	tanδ	Rated ripple current (mArms/105°C, 120Hz)
100(1K)	330	16*25	0.08	540
	470	16*30	0.08	715
	1000	18*40	0.08	985
160(2C)	3.3	6.3*11	0.20	32
	4.7	6.3*11	0.20	38
	10	8*12	0.20	65
		10*12	0.20	76
		10*12	0.20	98
	22	10*16	0.20	108
		10*20	0.20	120
		10*16	0.20	158
	33	10*20	0.20	165
		10*20	0.20	182
		12.5*20	0.20	205
	47	12.5*20	0.20	265
		12.5*25	0.20	318
		16*25	0.20	335
	220	16*30	0.20	568
330		18*35	0.20	710
470		18*40	0.20	870
200(2D)	1	6.3*11	0.20	16
	2.2	6.3*11	0.20	22
	3.3	6.3*11	0.20	32
	4.7	8*12	0.20	48
		8*12	0.20	78
	10	10*12	0.20	82
		10*16	0.20	86
		10*16	0.20	128
	22	10*20	0.20	132
		10*20	0.20	185
		12.5*20	0.20	194
	47	12.5*20	0.20	225
		12.5*25	0.20	308
		12.5*25	0.20	318
	100	16*25	0.20	345
		16*25	0.20	446
		16*30	0.20	560
	220	16*35	0.20	678
		18*30	0.20	695
		330	18*35	0.20
470	18*45	0.20	938	
250(2E)	2.2	6.3*11	0.20	22
	3.3	6.3*11	0.20	32
		8*12	0.20	34
		6.3*11	0.20	38
	4.7	8*12	0.20	48
		10*12	0.20	75
	10	10*16	0.20	84
		10*20	0.20	128
	22	12.5*20	0.20	145
		10*20	0.20	150
	33	12.5*20	0.20	185
		12.5*20	0.20	232
	47	12.5*25	0.20	245
		16*25	0.20	370
		16*30	0.20	400
150	16*35	0.20	468	
	18*35	0.20	660	
	18*40	0.20	702	
330	18*40	0.20	730	

WV (V _{dc})	Cap (μF)	Size ΦDxL(mm)	tanδ	Rated ripple current (mArms/105°C, 120Hz)
350(2V)	0.47	6.3*11	0.24	11
	1	6.3*11	0.24	16
	2.2	8*12	0.24	26
	3.3	8*12	0.24	34
		10*12	0.24	38
	4.7	8*12	0.24	48
		10*12	0.24	52
		10*12	0.24	68
	10	10*16	0.24	82
		10*20	0.24	88
		22	12.5*20	0.24
	33	12.5*20	0.24	184
		16*20	0.24	198
		16*25	0.24	250
	68	16*25	0.24	336
100	18*30	0.24	398	
400(2G)	1	6.3*11	0.24	16
	2.2	6.3*11	0.24	30
	3.3	8*12	0.24	34
		8*12	0.24	35
	4.7	10*12	0.24	38
		8*12	0.24	48
	10	10*12	0.24	52
		10*16	0.24	98
		10*20	0.24	115
	22	12.5*25	0.24	192
		16*20	0.24	258
		16*25	0.24	305
	47	16*30	0.24	465
		18*25	0.24	445
		18*25	0.24	474
100	16*40	0.24	544	
	18*30	0.24	532	
	18*35	0.24	588	
150	18*40	0.24	668	
450(2W)	0.47	8*12	0.24	11
	1	8*12	0.24	18
	2.2	8*12	0.24	25
	3.3	10*12	0.24	32
		10*16	0.24	40
	4.7	10*20	0.24	55
		10*20	0.24	90
	10	12.5*20	0.24	100
		12.5*25	0.24	168
		16*20	0.24	185
	33	16*25	0.24	215
		16*30	0.24	344
		18*30	0.24	455
	68	18*30	0.24	472
		18*35	0.24	530
18*40		0.24	582	
150	18*50	0.24	700	
500(2H)	4.7	10*20	0.24	60
	10	12.5*20	0.24	115
	15	12.5*25	0.24	140
	22	16*25	0.24	185
	33	18*25	0.24	215
	47	18*35	0.24	345
	68	18*40	0.24	455
	82	18*50	0.24	520
	100	22*40	0.24	550
	120	22*46	0.24	580