

5-160491-2 ✓ ACTIVE

FASTON | FASTON 187

TE Internal #: 5-160491-2

Receptacle, 18 – 14 AWG Wire Size, 1.03 – 2.62 mm² Wire Size,
Mating Tab Width 4.75 mm [.187 in], Straight, Brass, FASTON 187,
Quick Disconnects

[View on TE.com >](#)



Terminals & Splices > Quick Disconnects

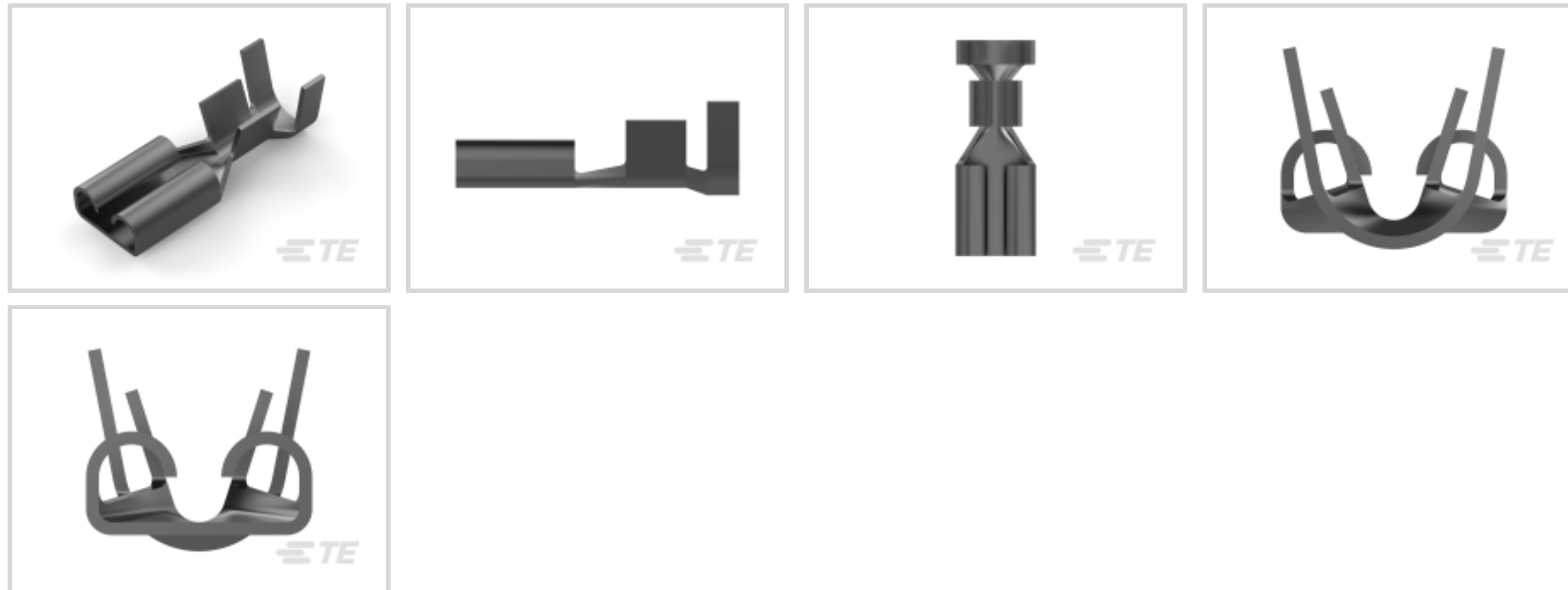

Quick Disconnect Terminal Type: **Receptacle**

Wire Size: 1.03 – 2.62 mm²

Mating Tab Width: 4.75 mm [.187 in]

Mating Tab Thickness: .81 mm [.032 in]

Features

Product Type Features

Insertion Force	Normal
-----------------	--------

Configuration Features

Connection Capacity	Single
---------------------	--------

Compatible With Wire & Cable Type	Discrete Wire
-----------------------------------	---------------

Contact Features

Quick Disconnect Terminal Type	Receptacle
--------------------------------	------------

Mating Tab Width	4.75 mm [.187 in]
------------------	-------------------

Mating Tab Thickness	.81 mm [.032 in]
----------------------	------------------

Terminal Orientation	Straight
----------------------	----------

Contact Base Material	Brass
-----------------------	-------

Terminal Plating Material	Tin
---------------------------	-----

Crimp Type	F-Crimp
------------	---------

Barrel Type	Open
-------------	------

Termination Features



Product Terminates To	Wire & Cable
-----------------------	--------------

Mechanical Attachment

Extraction Force	70 Newton
------------------	-----------

Wire Insulation Support	With
-------------------------	------

Mating Retention Type	Dimple
-----------------------	--------

Dimensions

Terminal Material Thickness	.3 mm[.012 in]
-----------------------------	----------------

Product Length	16 mm[.63 in]
----------------	---------------

Compatible Insulation Diameter Range	3 – 4 mm[.118 – .157 in]
--------------------------------------	--------------------------

Wire Size	1.03 – 2.62 mm ²
-----------	-----------------------------

Usage Conditions

Insulation Option	Uninsulated
-------------------	-------------

Operating Temperature Range	-40 – 110 °C[-40 – 230 °F]
-----------------------------	----------------------------

Industry Standards

Compatible With Agency/Standards Products	CSA, UL
---	---------

Packaging Features

Packaging Quantity	500
--------------------	-----

Packaging Method	Loose Piece/Carton
------------------	--------------------

Product Compliance

[For compliance documentation, visit the product page on TE.com>](#)

EU RoHS Directive 2011/65/EU	Compliant
------------------------------	-----------

EU ELV Directive 2000/53/EC	Compliant
-----------------------------	-----------

China RoHS 2 Directive MIIT Order No 32, 2016	No Restricted Materials Above Threshold
---	---

EU REACH Regulation (EC) No. 1907/2006	Current ECHA Candidate List: JUNE 2024 (241) Candidate List Declared Against: JUNE 2024 (241) Does not contain REACH SVHC
--	---

Halogen Content	Low Halogen - Br, Cl, F, I < 900 ppm per homogenous material. Also BFR/CFR/PVC Free
-----------------	---

Solder Process Capability	Not applicable for solder process capability
---------------------------	--

Product Compliance Disclaimer

This information is provided based on reasonable inquiry of our suppliers and represents our current actual knowledge based on the information they provided. This information is subject to change. The part numbers that TE has identified as EU RoHS compliant have a maximum concentration of 0.1% by weight in homogenous materials for lead, hexavalent chromium, mercury, PBB, PBDE, DBP, BBP, DEHP, DIBP, and 0.01% for cadmium, or qualify for an exemption to these limits as defined in the Annexes of Directive 2011/65/EU (RoHS2). Finished electrical and electronic equipment products will be CE marked as required by Directive 2011/65/EU. Components may not be CE marked. Additionally, the part numbers that TE has identified as EU ELV compliant have a maximum concentration of 0.1% by weight in homogenous materials for lead, hexavalent chromium, and mercury, and 0.01% for cadmium, or qualify for an exemption to these limits as defined in the Annexes of Directive 2000/53/EC (ELV). Regarding the REACH Regulation, the information TE provides on SVHC in articles for this part number is based on the latest European Chemicals Agency (ECHA) 'Guidance on requirements for substances in articles' posted at this URL: <https://echa.europa.eu/guidance-documents/guidance-on-reach>

Compatible Parts



TE Part # 63699-1
ADAPTER 187 FASTON TPBR



TE Part # 170141-2
187 FASTON, FLAG, REC., 20-16 AWG, TPBR



TE Part # 1742597-1
ADAPTER, FASTON, 250 REC, 187 TAB, BR



TE Part # 675930-1
CCII DAHT FASTON 187 20-14 ASSY BR

Also in the Series | FASTON 187



Crimp Terminal Housings(41)



Insertion & Extraction Tools(1)



Joints & Splices(1)



PCB Terminals(42)



Quick Disconnects(208)



Splices(1)

Customers Also Bought

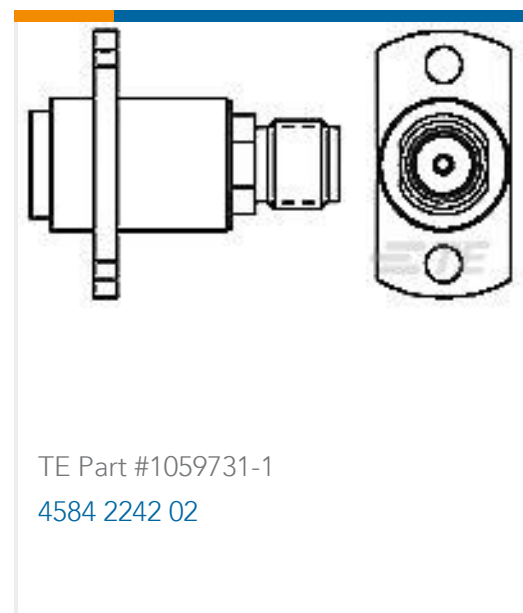
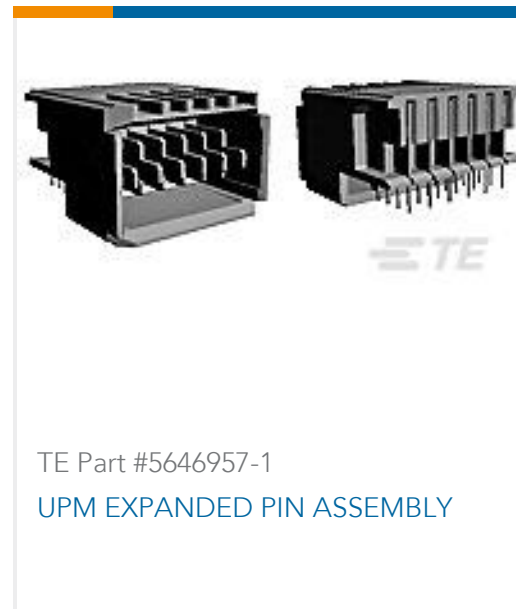
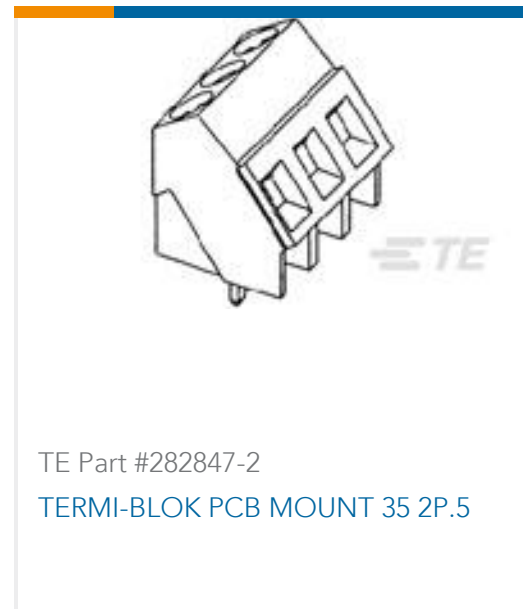

Documents

Product Drawings

[187 FASTON REC 18-14 AWG TPBR](#)

English

CAD Files

Customer View Model

[ENG_CVM_CVM_5-160491-2_K.2d_dxf.zip](#)

English

3D PDF

3D

Customer View Model

[ENG_CVM_CVM_5-160491-2_K.3d_igs.zip](#)

English

Customer View Model

[ENG_CVM_CVM_5-160491-2_K.3d_stp.zip](#)

English

By downloading the CAD file I accept and agree to the [Terms and Conditions](#) of use.

Product Specifications



EBGeneral Application Specification for Open Barrel Terminals**

English

Application Specification

English

Application Specification

English

Agency Approvals

UL Report

English