

SP4010 Series

0.48pF Diode Array

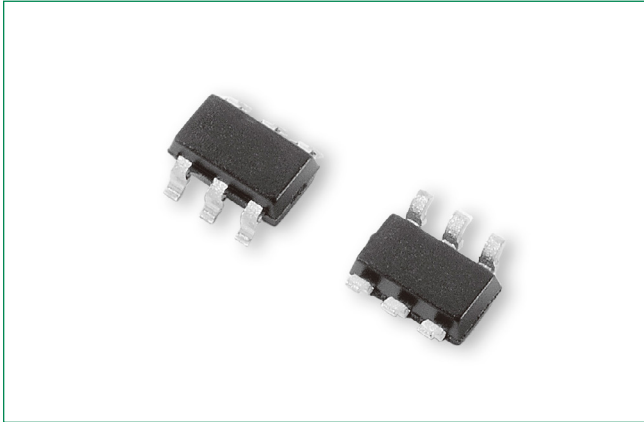

Additional Information



Resources



Accessories



Samples

Pinout

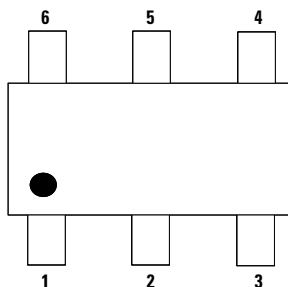

Description

The SP4010 integrates 2 channels of ultra low capacitance asymmetrical protection for electronic equipment that may experience destructive electrostatic discharges (ESD). These robust components can safely absorb repetitive ESD strikes above the maximum contact level specified in the IEC 61000-4-2 international standard ($\pm 30\text{kV}$ contact discharge) without performance degradation.

The extremely low off-state capacitance also makes it ideal for protecting high speed signal lines such as USB3.0, HDMI, USB2.0, and eSATA.

Features & Benefits

- ESD, IEC 61000-4-2, $\pm 30\text{kV}$ contact, $\pm 30\text{kV}$ air
- EFT, IEC 61000-4-4, 40A (tP=5/50ns)
- Lightning, IEC 61000-4-5 2nd edition, 23A (tP=8/20 μs)
- Low capacitance of 0.48pF @0V, 1MHz (TYP) per I/O
- Low leakage current of 0.2 μA (MAX) at 10V
- Moisture Sensitivity Level (MSL -1)
- Halogen free, lead free and RoHS compliant

Applications

- LCD/PDP TVs
- External Storages
- DVD/Blu-ray Players
- Desktops
- MP3/PMP
- Set Top Boxes
- Smartphones
- Ultrabooks/Notebooks
- Digital Cameras

Functional Block Diagram

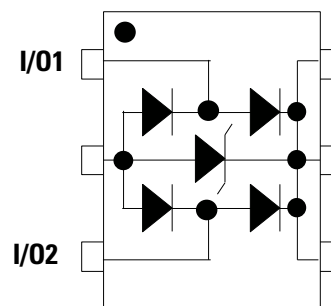

Life Support Note:

Not Intended for Use in Life Support or Life Saving Applications

The products shown herein are not designed for use in life sustaining or life saving applications unless otherwise expressly indicated.

SP4010 Series

0.48pF Diode Array

Absolute Maximum Ratings

Symbol	Parameter	Value	Units
I_{PP}	Peak Current ($t_p=8/20\mu s$)	23	A
T_{OP}	Operating Temperature	-40 to 125	°C
T_{STOR}	Storage Temperature	-55 to 150	°C

Caution: Stresses above those listed in "Absolute Maximum Ratings" may cause permanent damage to the component. This is a stress only rating and operation of the component at these or any other conditions above those indicated in the operational sections of this specification is not implied.

Electrical Characteristics ($T_{OP}=25^\circ C$)

Parameter	Symbol	Test Conditions	Min	Typ	Max	Units
Reverse Standoff Voltage	V_{RWM}	$I_R = 1\mu A$			10	V
Breakdown Voltage	V_{BR}	$I_R = 1mA$, I/O to I/O	10.5	12.5		V
Reverse Leakage Current	I_{LEAK}	$V_R=10V$, I/O to I/O		0.01	0.2	μA
Clamp Voltage ¹	V_C	$I_{PP}=16A$, $t_p=8/20\mu s$, I/O to I/O		27.5	29	V
		$I_{PP}=23A$, $t_p=8/20\mu s$, I/O to I/O		39	43	V
Dynamic Resistance ²	R_{DYN}	TLP, $t_p=100ns$, I/O to I/O		0.7		Ω
ESD Withstand Voltage ¹	V_{ESD}	IEC 61000-4-2 (Contact Discharge)	± 30			kV
		IEC 61000-4-2 (Air Discharge)	± 30			kV
Diode Capacitance ¹	$C_{I/O-I/O}$	Reverse Bias=0V, $f=1MHz$, I/O to I/O		0.48	1	pF

Note:

- Parameter is guaranteed by design and/or component characterization.
- Transmission Line Pulse (TLP) with 100ns width, 2ns rise time, and average window $t_1=70ns$ to $t_2=90ns$

Positive Transmission Line Pulsing (TLP) Plot

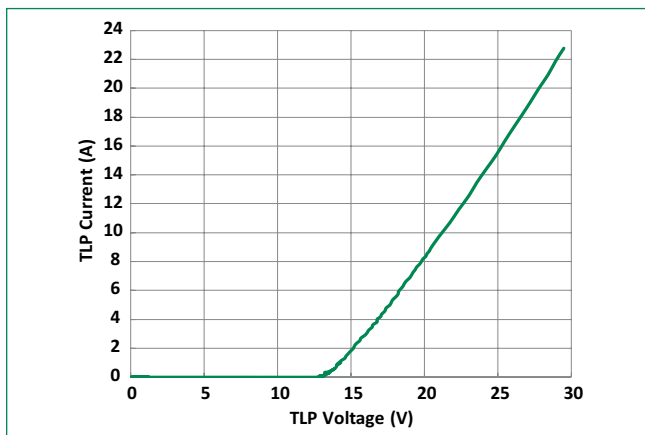

Negative Transmission Line Pulsing (TLP) Plot

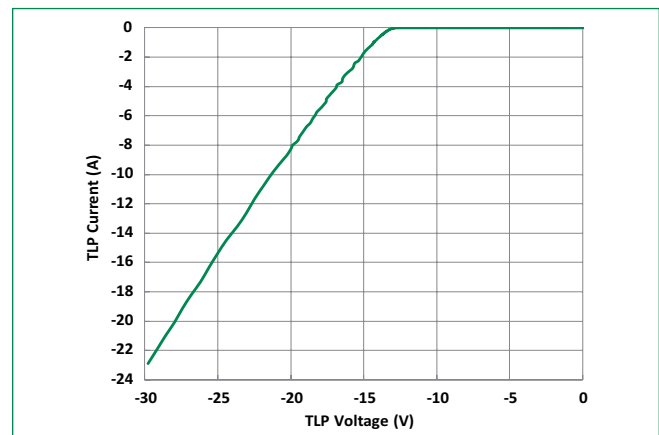

SP4010 Series

0.48pF Diode Array

Clamping Voltage vs. IPP for 8/20 μs waveshape

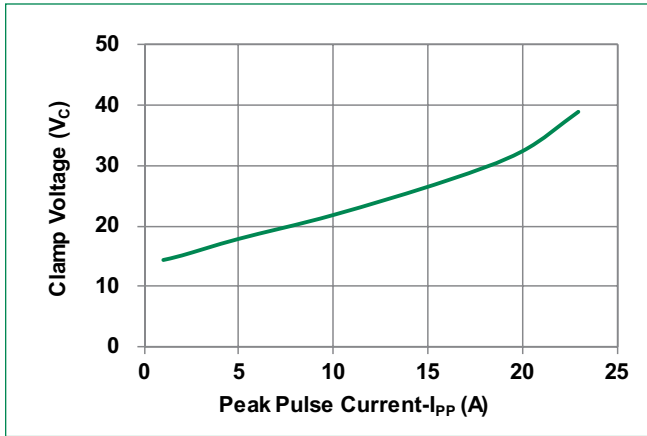

8/20 μs Pulse Waveform

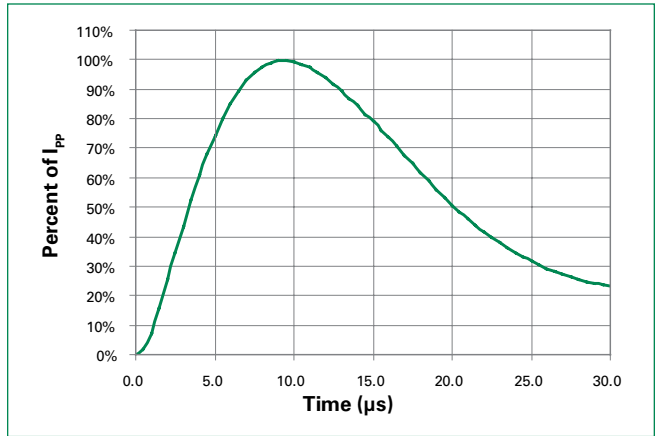

IEC 61000-4-2 +8 kV Contact ESD Clamping Voltage

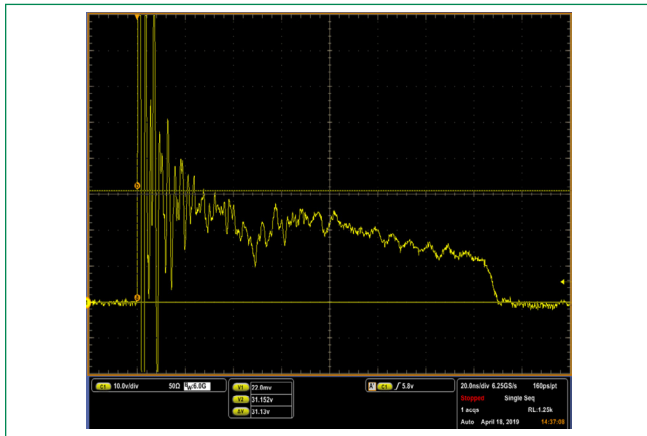

IEC 61000-4-2 -8 kV Contact ESD Clamping Voltage

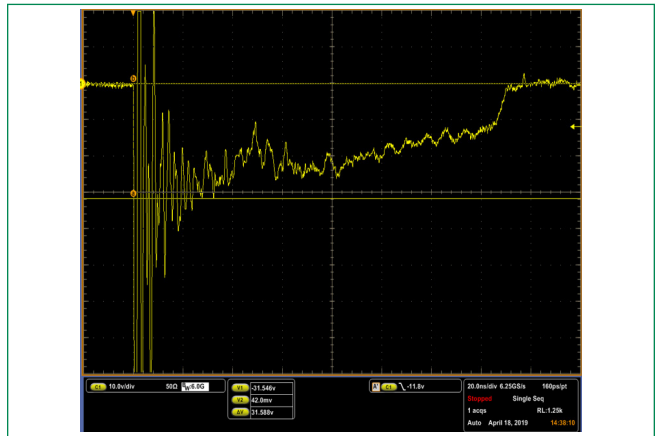

SP4010 Series

0.48pF Diode Array

Soldering Parameters

Reflow Condition		Pb – Free assembly
Pre Heat	- Temperature Min ($T_{s(min)}$)	150°C
	- Temperature Max ($T_{s(max)}$)	200°C
	- Time (min to max) (t_s)	60 – 180 secs
Average ramp up rate (Liquidus) Temp (T_L) to peak		3°C/second max
$T_{s(max)}$ to T_L - Ramp-up Rate		3°C/second max
Reflow	- Temperature (T_L) (Liquidus)	217°C
	- Temperature (t_L)	60 – 150 seconds
Peak Temperature (T_p)		260 ^{+0/-5} °C
Time within 5°C of actual peak Temperature (t_p)		20 – 40 seconds
Ramp-down Rate		6°C/second max
Time 25°C to peak Temperature (T_p)		8 minutes Max.
Do not exceed		260°C

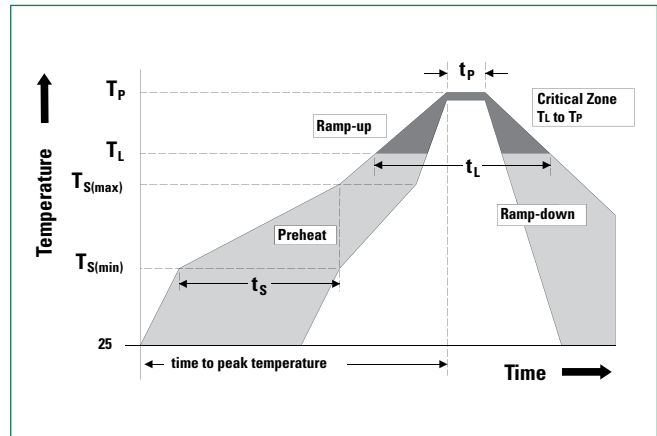

Ordering Information

Part Number	Package	Min. Order Qty.
SP4010-02HTG	SOT23-6L	3000

Product Characteristics

Lead Plating	Matte tin
Lead Material	Copper Alloy
Lead Coplanarity	0.0004 inches (0.102mm)
Substrate Material	Silicon
Body Material	Molded Compound
Flammability	UL Recognized compound meeting flammability rating V-0

Part Marking System

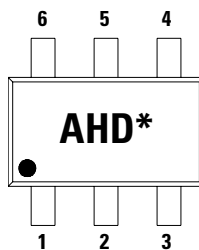

AH : Part code
D : Assembly code
* : Date code

Part Numbering System

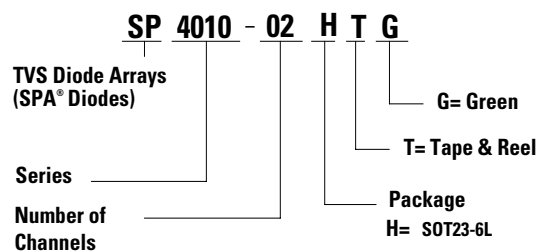

SP4010 Series

0.48pF Diode Array

Package Dimensions – SOT23-6L

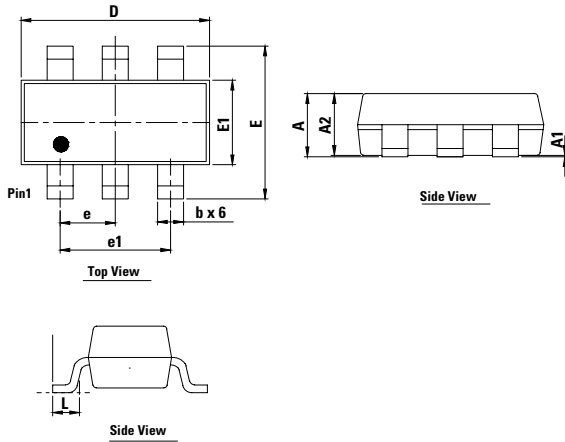

Symbol	Millimeters		
	Min	Nom	Max
A	-	-	1.45
A1	0.00	-	0.15
A2	0.90	1.15	1.30
D	2.75	2.90	3.05
E	2.60	2.80	3.00
E1	1.45	1.60	1.75
e	0.95 BSC		
e1	1.90 BSC		
L	0.30	0.50	0.60
∅	0°	4°	8°

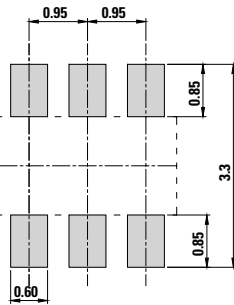

Recommended soldering pad layout (unit :mm)

Embossed Carrier Tape & Reel Specification – SOT23-6L

8mm TAPE AND REEL

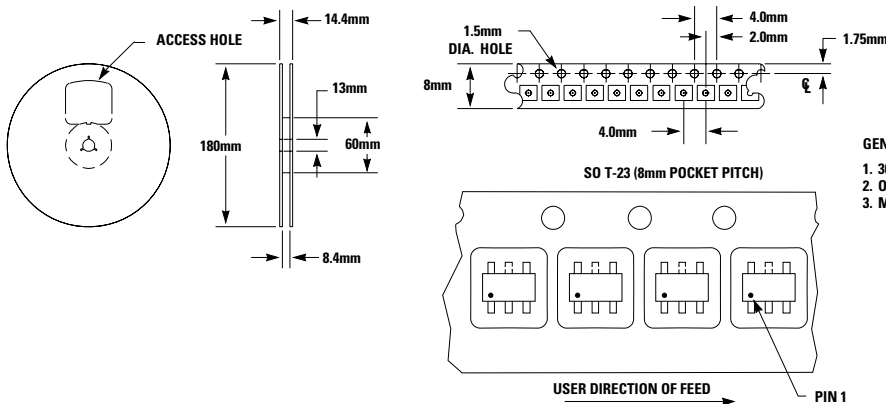

Disclaimer Notice - Information furnished is believed to be accurate and reliable. However, users should independently evaluate the suitability of and test each product selected for their own applications. Littelfuse products are not designed for, and may not be used in, all applications. Read complete Disclaimer Notice at <http://www.littelfuse.com/disclaimer-electronics>.