



承 认 书

SPECIFICATION FOR APPROVAL

客户名称 CUSTOMER: _____

品名 DESCRIPTION: ZH型压接式条形连接器

料号 CUSERTOMER PART NO: A1501

客户确认 APPROVED SIGNATURES

核准 APPROVAL: _____

日期 DATE: _____

工程 ENGINEERING: _____

日期 DATE: _____

品管 QC: _____

日期 DATE: _____

承认结果: 承认 不承认

重新送样

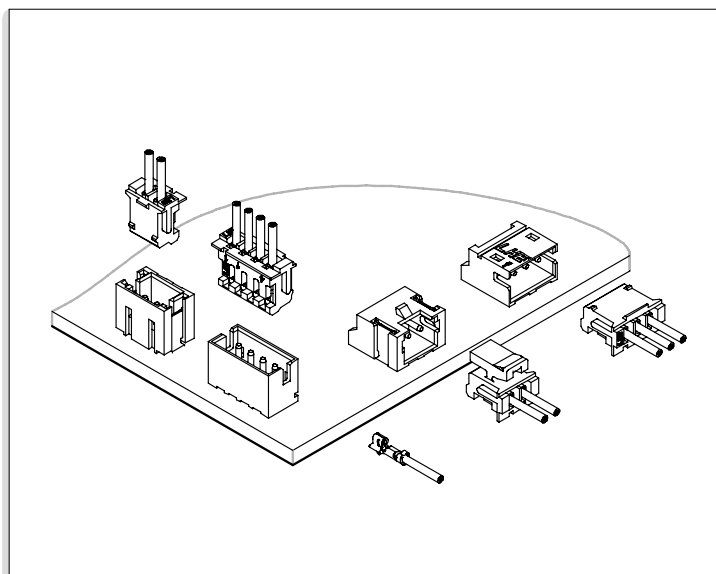

规格 Specifications

1. 极数 Poles: 2 to 16P
2. 额定电流 Current rating: 1.0A AC,DC
3. 额定电压 Voltage rating: 50V AC,DC
4. 温度范围 Temperature range: -25°C to +105°C
(含通电温度上升值)
(Including temperature rise in applying electrical current)
5. 接触电阻 Contact resistance: 初期 Initial value / $\leq 20m\Omega$
环境测试后 After environmental testing / $\leq 30m\Omega$
6. 绝缘电阻 Insulation resistance: $\geq 500M\Omega$
7. 耐电压 Withstanding voltage: 500V AC/minute
8. 适用线规 Applicable wire: AWG #32 to #26
9. 适用基板厚度 Applicable PC board thickness: 1.2~1.6mm



目录(COVER)	1
料号说明(DESCRIPTION OF ITEM NUMBER)	2
系列说明和安装尺寸(Series illustrated and Mounting Measurement)	5
图纸(DRAWING)	9
产品性能测试(PERFORMANCE TEST)	21
实验报告(TEST REPORT)	26
认证(CERTIFICATION)	29
PA66 RoHS报告(PA66 RoHS REPORT)	39
端子 RoHS报告(TERMINAL RoHS REPORT)	50
LCP RoHS 报告(LCP RoHS REPORT)	58
MSDS	69
反馈与建议(FEEDBACK AND SUGGESTIONS)	82

制订 Edit: 王夫 日期 DATE: 2024-05-10

审核 Check: 天琴 日期 DATE: 2024-05-10

批准 Approval: 季育文 日期 DATE: 2024-05-10

壳体料号说明 HOUSING

A 1501 - S H B 02 X2 - N* - * - ** - ** - ** - ** - **

A: Wire to Board Connectors
 B: Board-in Connectors
 C: Wire to Wire Connectors
 D: Hard Splices Connectors
 F: FFC/FPC Connectors
 I: IDC

系列号 Series Number

特征类别(默认空)
 Feature Category: S=锁片型

产品类别 H=壳体 Housing
 P=密封件 Water Proofing
 Product Category: F=配件 Fitting

同类别多型号序号(默认空)
 Same Series Different Type: B-ZZ

单列极数 The Pin Number of Single Row: 01-**

多列列数 The Pin Number of Several Row: X2~X* (无则空)

M为堵孔, *为堵孔序号(例M1.2.5)(无则空)

1=PA66	10=PC
2=PA66灼热丝-G	11=PA66无卤灼热丝
3=PA46	12=PA66高灼热丝B
4=PA6T	13=PA66增强
5=PA9T	
6=PBTP	
7=PPPO	
8=LCP	
壳体材料: 9=U=UL	

V2 UL阻燃等级标准(默认不注明)
 V0 UL阻燃等级标准
 Z=灼热丝是按照(IEC60695/GB/T5169)标准,
 符合GWIT750°C, GWFI960°C

壳体材料特性
 Housing Material Specialty: ZG=灼热丝加玻纤

OR=橙色 Orange
 P=粉色 Pink
 R=红色 Red
 VI=紫色 Violet
 Y=黄色 Yellow
 GY=灰色 Gray
 BK=黑色 Black
 G=绿色 Green
 BL=蓝色 Blue
 BR=棕色 Brown
 TR=透明白 Transparent
 W=白色 White
 EC=米白 ECRU

壳体颜色
 Housing Color: TG=透明绿 Transparent Green
 壳体材料2/3/4/5/8/12默认米色
 壳体材料7默认黑色
 壳体材料1/6/9/10/11默认白色
 壳体材料13默认透明
 (默认可为空)

无卤标识
 无卤产品加HF,有卤默认为空

客户专用代码
 Customer Special Code: 表示和常规件不同,用来代表某个客户

备注:*部分内容只在产品标签中体现! 其他特殊要求位置不固定

ZH型料号说明 Description of item number



针座料号说明 WAFER

A 1501 -DHWVB 02 X2 -N* -C* - ** - ** - * - ** - ** - ** - ** - **

A: Wire to Board Connectors
 F: FFC/FPC Connectors
 I: IDC

系列号 Series Number

DB=防呆柱+全包
 B=全包 All inclusive
 DH=防呆柱+高背型

特征类别(默认空)H=高背型 High box type
 Feature Category: D=固定防呆柱 Fixed

WV=直针座 Straight Angle
 WR=弯针座 Right Angle

产品类别
 Product Category: SV=立贴式 V-SMT
 SR=卧贴式 R-SMT

同类别多型号序号(默认空)
 Same Series Different Type: B-ZZ

单列极数 The Pin Number of Single Row: 01~**
 多列列数 The Pin Number of Several Row: X2~X* (无则空)
 N为缺针,M为堵孔,*为序号(例N1.2.5)(无则空)
 C为插针样式不同(除打点、缺针外)*为序号(无则空)

打点样式
 Point Style:K为打点,K2.4表示在第2枚,第4枚上打点,默认打点无数字标注(无则空)

接触件材料 P=磷青铜 Phos.Bronze
 Contact Material: B=黄铜 Brass

0=素材酸洗 None
 1=镀镍 Nickel Plating
 2=镀亮锡 Tin Plating
 3=镀镍氟光锡 Matt Tin-Nickel Plating
 4=镀铅锡 Tin-Lead Plating
 5=镀铜锡 Tin-Cu Plating
 6=镀镍银 Silver-Nickel Plating
 7=镀镍金 Gold-Nickel Plating
 8=镀镍局部金 Half Gold-Nickel Plating
 9=镀亮锡局部金 Half Gold-Tin Plating

表面处理
 Surface Processing: 10=镀镍亮锡 Tin-Nickel Plating (A5001默认B3)

1=PA66	6=PBT	11=PA66无卤灼热丝
2=PA66灼热丝-G	7=PPO	12=PA66高灼热丝B
3=PA46	8=LCP	13=PA66增强

壳体材料
 Housing Material: 4=PA6T 9=U=UL 10=PC

V2 UL阻燃等级标准(默认不注明)
 V0 UL阻燃等级标准
 Z=灼热丝是按照(IEC60695/GB/T5169)标准,
 符合GWIT750°C,GWFI960°C

壳体材料特性
 Housing Material Specialty: ZG=灼热丝加玻纤

其他特殊要求
 Other Special Requirements: 如:SE(对固定力要求高5N)

OR=橙色 Orange	
P=粉色 Pink	
R=红色 Red	
VI=紫色 Violet	
Y=黄色 Yellow	
GY=灰色 Gray	
BK=黑色 Black	
G=绿色 Green	
BL=蓝色 Blue	
BR=棕色 Brown	
TR=透明白 Transparent	壳体材料2/3/4/5/8/12默认米色
W=白色 White	壳体材料7默认黑色
EC=米白 ECRU	壳体材料1/6/9/10/11默认白色
Housing Color: TG=透明绿 Transparent Green	壳体材料13默认透明 (默认可为空)

无卤标识
 无卤产品加HF,有卤默认为空

客户专用代码
 Customer Special Code: 表示和常规件不同,用来代表某个客户

备注:*部分内容只在产品标签中体现! 其他特殊要求位置不固定

ZH型料号说明 Description of item number



端子料号说明 TERMINAL

A 1501 N - T 2 2 A 30 5 P 2(*)Y-1-*(*)*

A: Wire to Board Connectors
 B: Board-in Connectors
 C: Wire to Wire Connectors
 F: FFC/FPC Connectors
 I: IDC
 D: Chain Terminals and Splices

系列号 Series Number

K=直形带锁 N=直形
 Z=旗形带锁 Q=旗形
 X=横插带锁 H=横插
 Y=叉形端子 J=插片
 R=环形端子 C=圆形
 G=接线端子
 W=鲨鱼齿端子
 特征类别(默认空) B=子弹形端子
 Feature Category: U=耳扒形端子

产品类别 Product Category: T=端子 Terminal

同类别多型号序号(默认空)
 Same Series Different Type: 1-9

同型号多尺寸序号(默认空)
 Same Type Different size: 1-9

适用线规(默认空) A=小脚 B=中脚
 Applicable Wire: C=高脚 D=大脚

料带厚度单位: mm X100 (0.3X100=30 默认空)

配合厚度单位: mm X10 (0.5X10=5 默认空)
 注: 所有<灰色>说明, 为D系列分类附加料号及说明!

Z=紫铜 Copper
 S=不锈钢 Stainless Steel
 P=磷青铜 Phos.Bronze
 材质 Material: B=黄铜 Brass

0=素材酸洗 None
 1=镀镍 Nickel Plating
 2=镀亮锡 Tin Plating
 3=镀镍光锡 Matt Tin-Nickel Plating
 4=镀铅锡 Tin-Lead Plating
 5=镀铜锡 Tin-Cu Plating
 6=镀镍银 Silver-Nickel Plating
 7=镀镍金 Gold-Nickel Plating
 8=镀镍局部金 Nickel-Gold
 9=镀亮锡局部金 Half Gold-Tin Plating
 10=镀镍亮锡 Tin-Nickel Plating

表面处理
 Surface processing:

镀层厚度(默认空)

包装说明: Y=有字、N=无字

包装方式: 0=散装(袋装)、1=盘装、4=八角盘装、5=编带装 (常规默认空)

包装数量: -**K: 客户定制数量,默认数量为空

客户专用代码
 Customer Special Code: 表示和常规件不同,用来代表某个客户

其他说明: 如(U)=UL、软、低铅等

备注:表面处理内容只在产品标签中体现! 其他特殊要求位置不固定

其它料号说明 OTHER

P 0001 - B

P: Other Types

产品序号 Product Number

同型号序号 Same Series Different Type: B-Z
 (默认空)

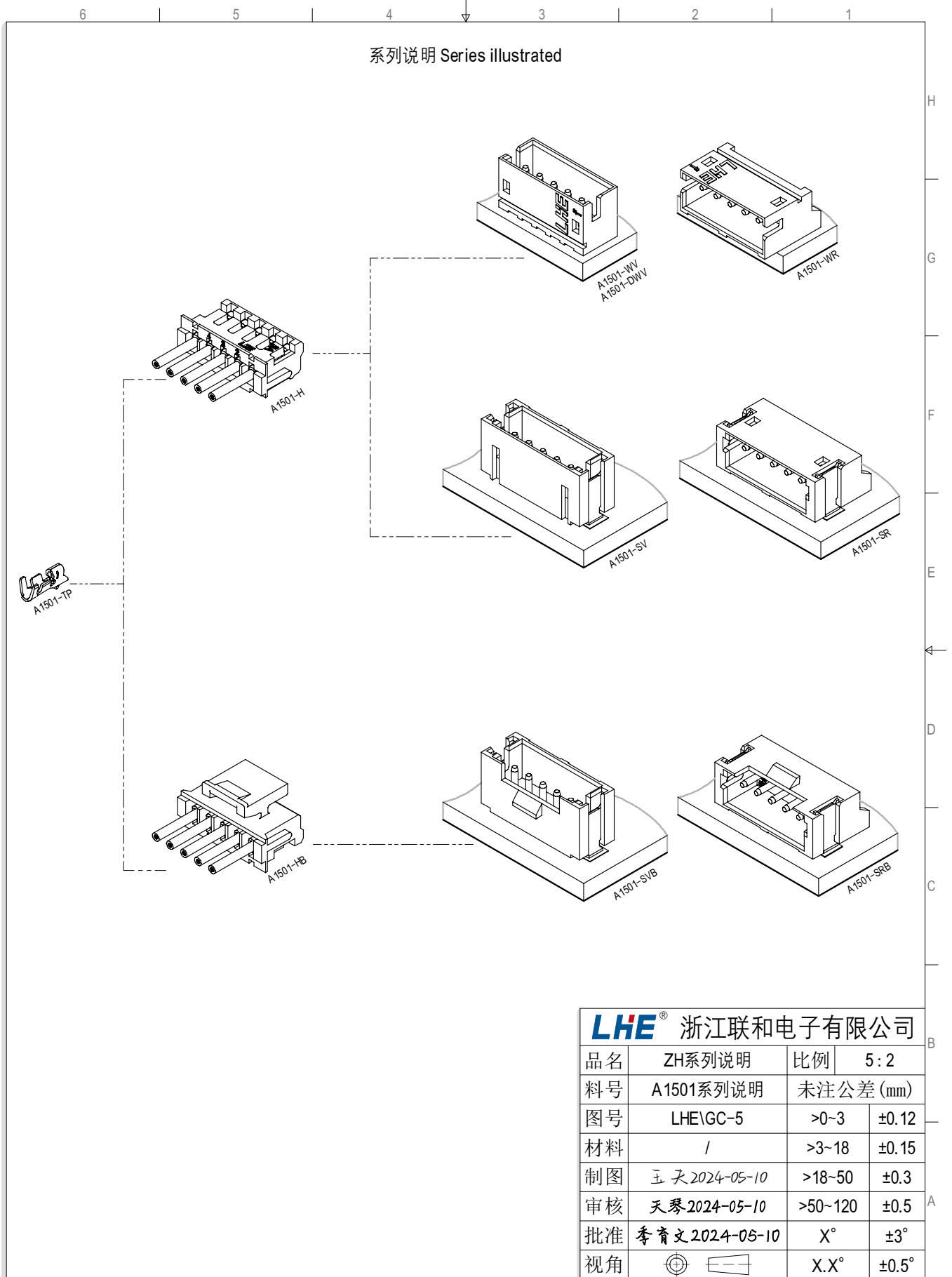

LHE® 浙江联和电子有限公司			
品名	ZH系列说明	比例	5:2
料号	A1501系列说明	未注公差(mm)	
图号	LHE\GC-5	>0~3	±0.12
材料	/	>3~18	±0.15
制图	王天2024-05-10	>18~50	±0.3
审核	天琴2024-05-10	>50~120	±0.5
批准	李育文2024-05-10	X°	±3°
视角		X.X°	±0.5°

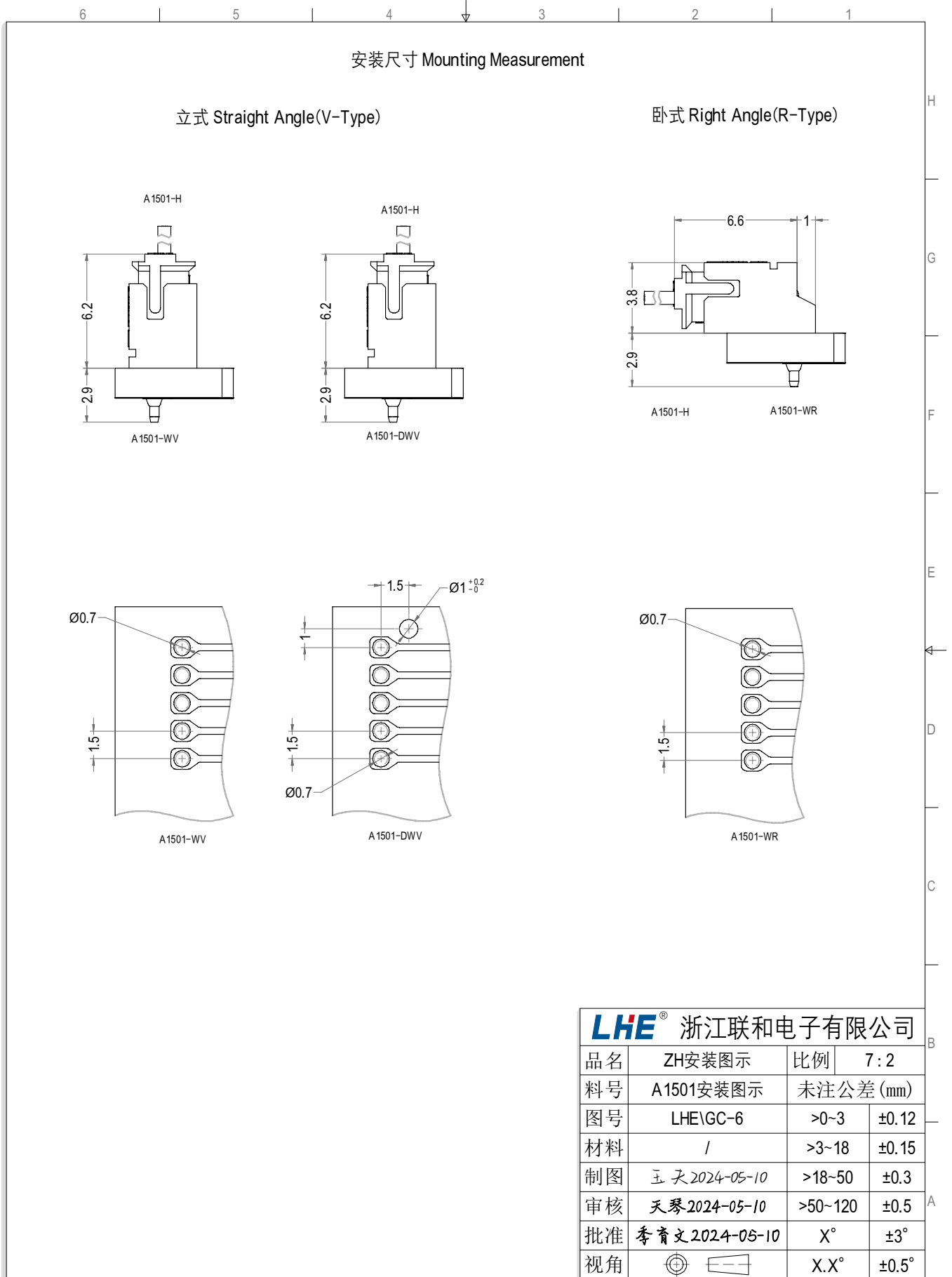

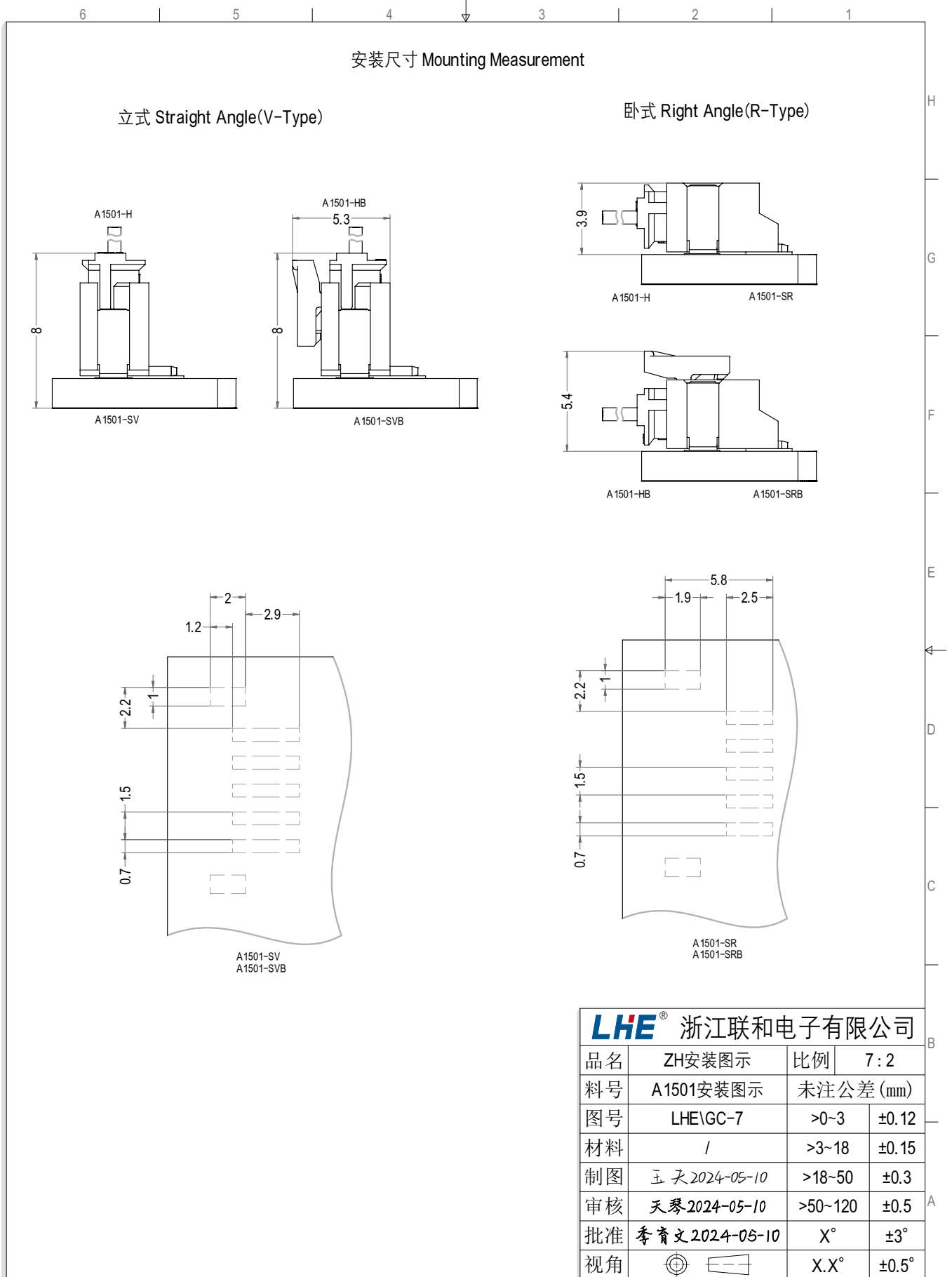

REV	修订记录	修改人	修订日期
1	增加产品特征示例	YF	2024/12/25

产品示例

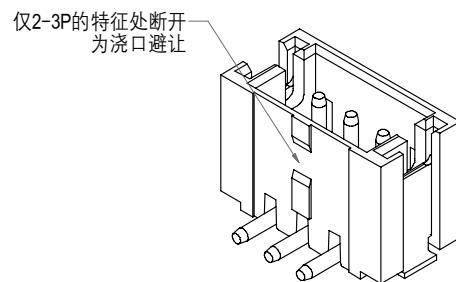
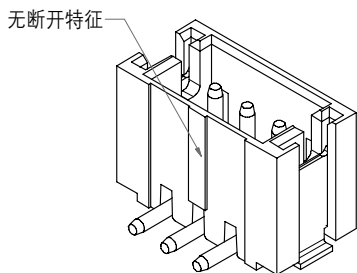
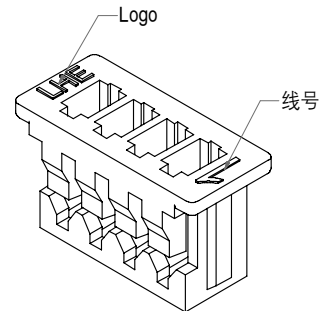
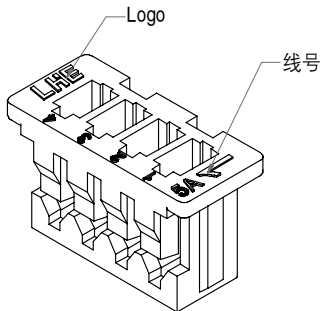
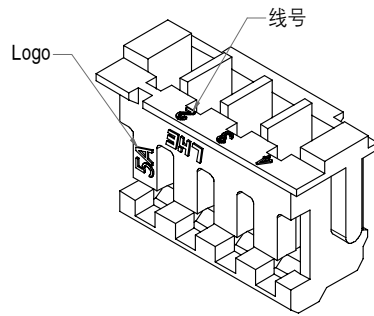
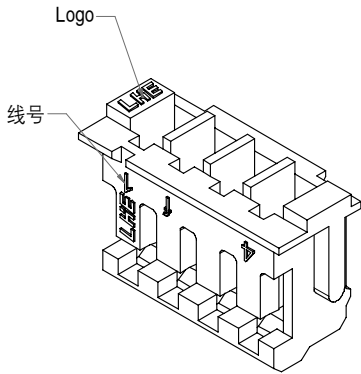

注意：
如：刻字，线号，注塑口等特征
且该特征不影响实际使用情况下位置不固定
恕不另行通告，详情请垂询本公司。

LHE® 浙江联和电子有限公司			
品名	示例说明	比例	4: 1
料号	示例说明	未注公差(mm)	
图号	LHE\GC-8	>0~3	±0.12
材料	/	>3~18	±0.15
制图	玉天 2024-12-25	>18~50	±0.3
审核	天琴 2024-12-25	>50~120	±0.5
批准	季育文 2024-12-25	X°	±3°
视角		X.X°	±0.5°

ZH型连接器承认书图面

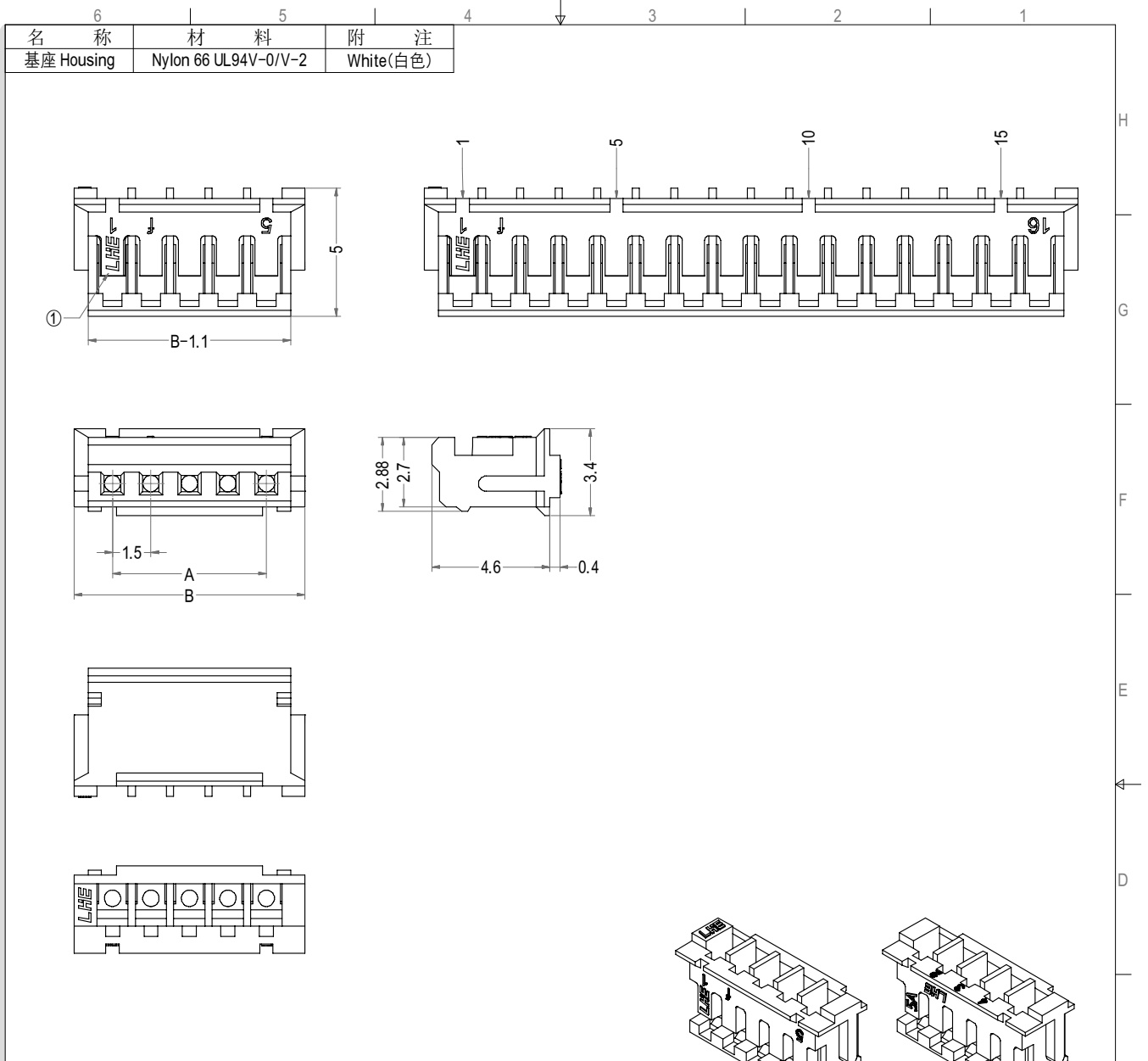

Poles	Part No.	Description	DIM=A	DIM=B
2	A1501-H02	ZH-2Y	1.50	4.50
3	A1501-H03	ZH-3Y	3.00	6.00
4	A1501-H04	ZH-4Y	4.50	7.50
5	A1501-H05	ZH-5Y	6.00	9.00
6	A1501-H06	ZH-6Y	7.50	10.50
7	A1501-H07	ZH-7Y	9.00	12.00
8	A1501-H08	ZH-8Y	10.50	13.50
9	A1501-H09	ZH-9Y	12.00	15.00
10	A1501-H10	ZH-10Y	13.50	16.50
11	A1501-H11	ZH-11Y	15.00	18.00
12	A1501-H12	ZH-12Y	16.50	19.50
13	A1501-H13	ZH-13Y	18.00	21.00
14	A1501-H14	ZH-14Y	19.50	22.50
15	A1501-H15	ZH-15Y	21.00	24.00
16	A1501-H16	ZH-16Y	22.50	25.50
17	A1501-H17	ZH-17Y	24.00	27.00
18	A1501-H18	ZH-18Y	25.50	28.50
19	A1501-H19	ZH-19Y	27.00	30.00
20	A1501-H20	ZH-20Y	28.50	31.50

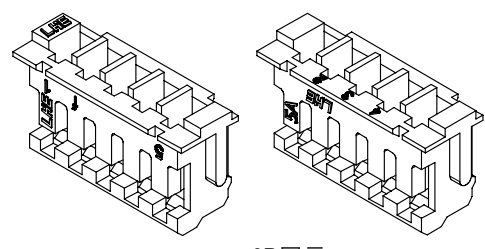

3D图示

注：有2种刻字是随机发货，不影响产品性能和使用！

LHE® 浙江联和电子有限公司			
品名	ZH-Y	比例	4:1
料号	A1501-H	未注公差(mm)	
图号	LHE\GC-9	>0~3	±0.12
材料	Nylon66UL94V-0/V-2	>3~18	±0.15
制图	王天 2024-05-10	>18~50	±0.3
审核	天琴 2024-05-10	>50~120	±0.5
批准	李育文 2024-05-10	X°	±3°
视角		X.X°	±0.5°

ZH型连接器承认书图面

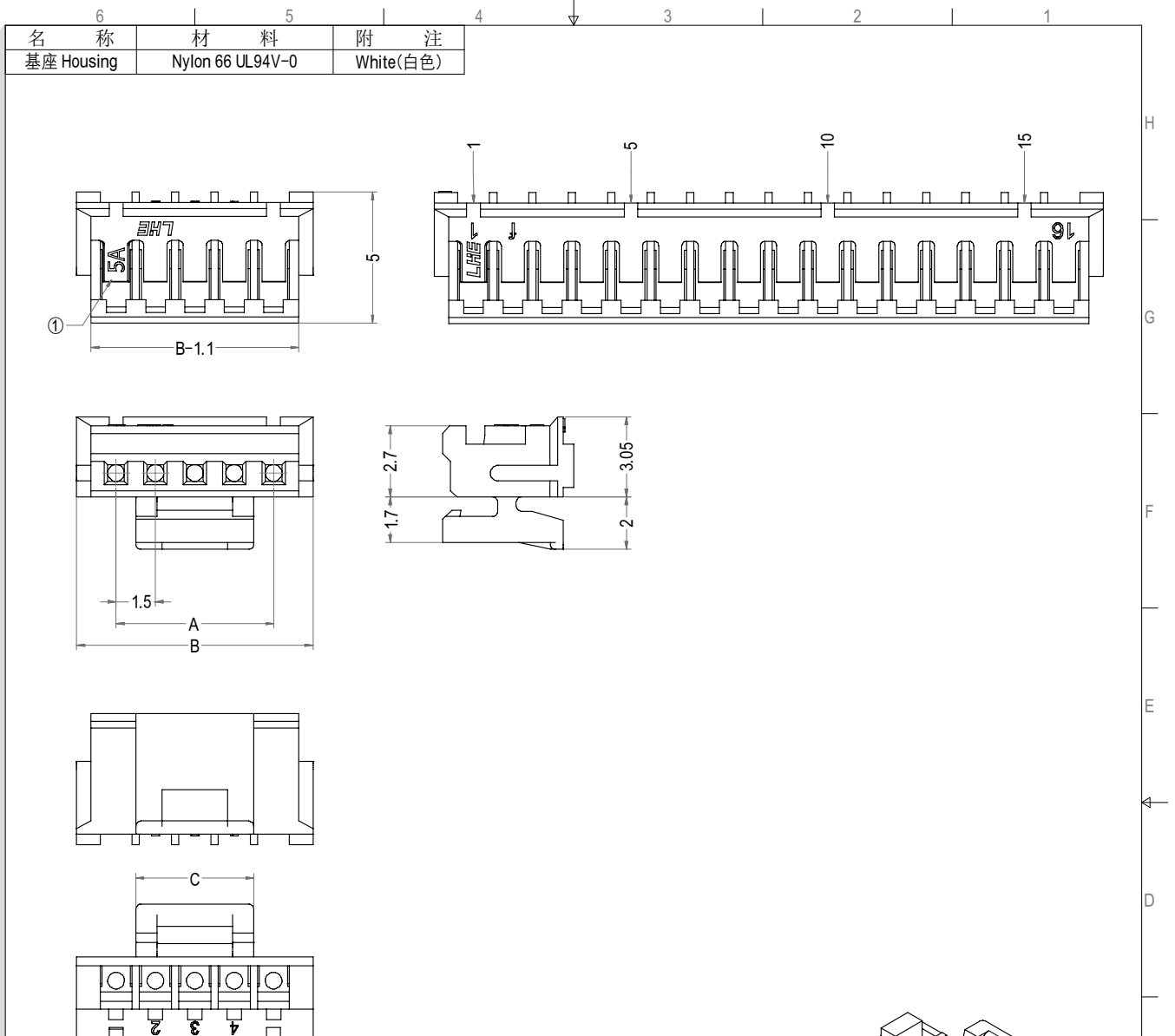

Poles	Part No.	Description	DIM=A	DIM=B	DIM=C
2	A 1501-HB02	ZHB-2Y	1.50	4.50	2.60
3	A 1501-HB03	ZHB-3Y	3.00	6.00	3.00
4	A 1501-HB04	ZHB-4Y	4.50	7.50	4.50
5	A 1501-HB05	ZHB-5Y	6.00	9.00	4.50
6	A 1501-HB06	ZHB-6Y	7.50	10.50	4.50
7	A 1501-HB07	ZHB-7Y	9.00	12.00	4.50
8	A 1501-HB08	ZHB-8Y	10.50	13.50	4.50
9	A 1501-HB09	ZHB-9Y	12.00	15.00	4.50
10	A 1501-HB10	ZHB-10Y	13.50	16.50	9.00
11	A 1501-HB11	ZHB-11Y	15.00	18.00	9.00
12	A 1501-HB12	ZHB-12Y	16.50	19.50	9.00
13	A 1501-HB13	ZHB-13Y	18.00	21.00	9.00
14	A 1501-HB14	ZHB-14Y	19.50	22.50	9.00
15	A 1501-HB15	ZHB-15Y	21.00	24.00	9.00
16	A 1501-HB16	ZHB-16Y	22.50	25.50	9.00
17	A 1501-HB17	ZHB-17Y	24.00	27.00	9.00
18	A 1501-HB18	ZHB-18Y	25.50	28.50	9.00
19	A 1501-HB19	ZHB-19Y	27.00	30.00	9.00
20	A 1501-HB20	ZHB-20Y	28.50	31.50	9.00

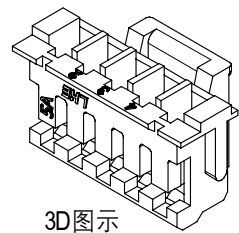

3D图示

LHE® 浙江联和电子有限公司			
品名	ZHB-Y	比例	4:1
料号	A 1501-HB	未注公差(mm)	
图号	LHE\GC-10	>0~3	±0.12
材料	Nylon 66 UL94V-0	>3~18	±0.15
制图	王天 2024-05-10	>18~50	±0.3
审核	天琴 2024-05-10	>50~120	±0.5
批准	李育文 2024-05-10	X°	±3°
视角		X.X°	±0.5°

ZH型连接器承认书图面

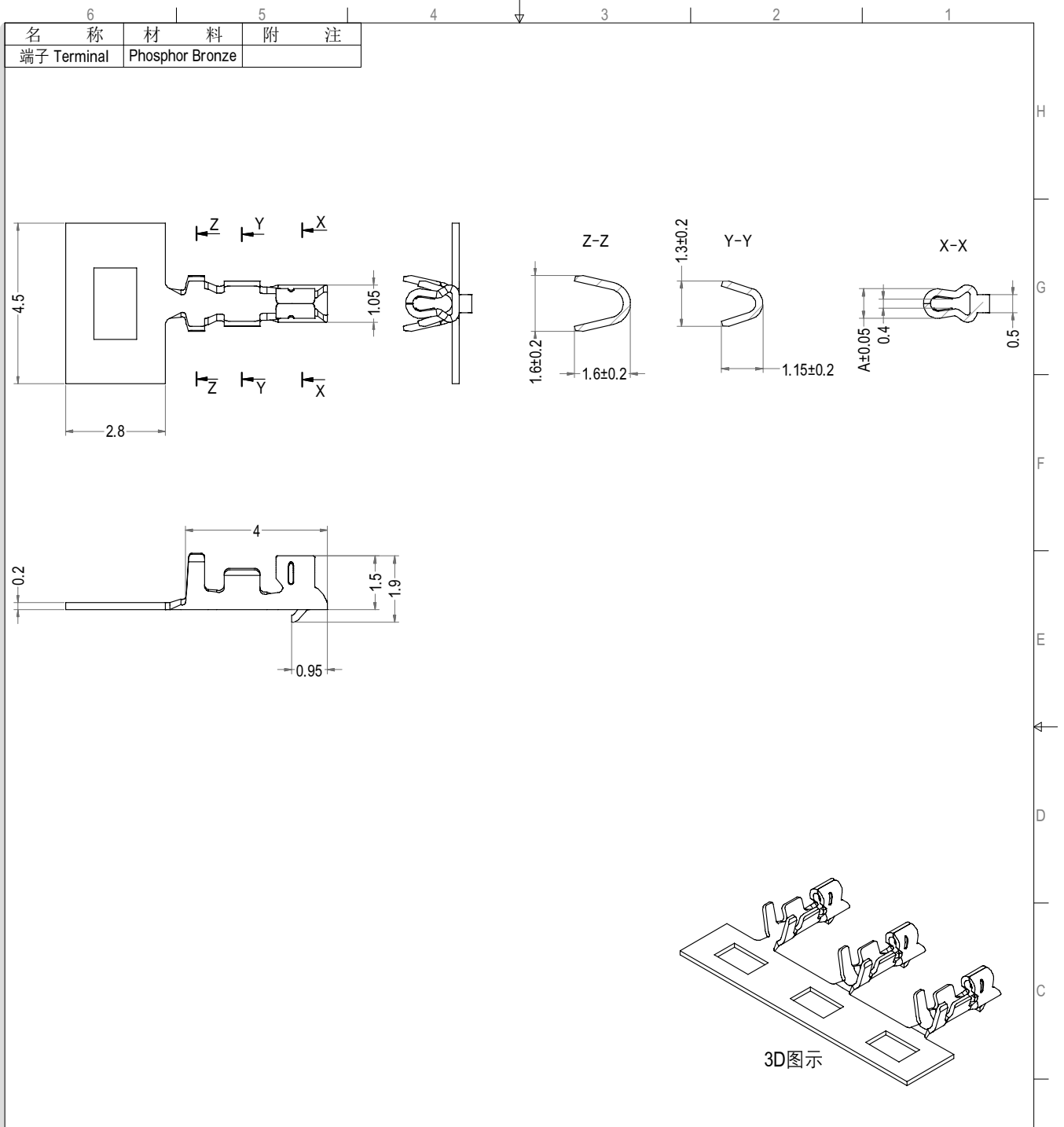

名称	材料	附注
端子 Terminal	Phosphor Bronze	

Part No.	Description	A	Finish	Qty/reel
A1501-T21P	ZH-T21	0.83	Tin	11,000pcs
A1501-T12P	ZH-T12	0.85	Tin	11,000pcs

LHE® 浙江联和电子有限公司

品名	ZH-T	比例	6:1
料号	A1501-T	未注公差(mm)	
图号	LHE\GC-11	>0~3	±0.12
材料	Phosphor Bronze	>3~18	±0.15
制图	玉天 2024-05-10	>18~50	±0.3
审核	天琴 2024-05-10	>50~120	±0.5
批准	李育文 2024-05-10	X°	±3°
视角		X.X°	±0.5°

ZH型连接器承认书图面



6	5	4	3	2	1
名称	材料	数量	附注		
基座 Housing	Nylon 66 UL94V-0	1	White(白色)		
针 Wafer	黄铜镀锡 Brass Tin	N			

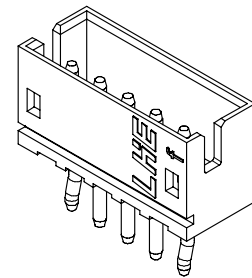
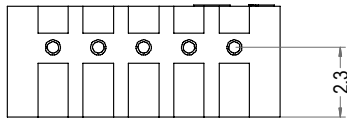
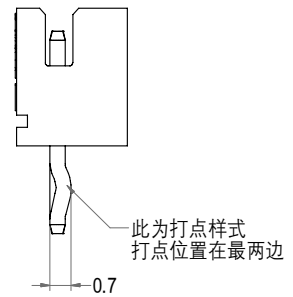
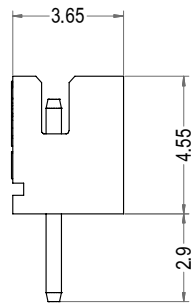
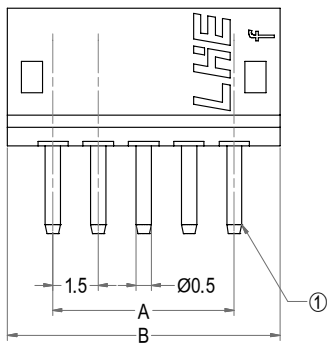
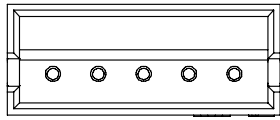

3D图示(打点样式)

Poles	Part No.1	Description 1	Part No.2	Description 2	DIM=A	DIM=B
2	A1501-WV02-K	ZH-2A打点	A1501-WV02	ZH-2A	1.50	4.50
3	A1501-WV03-K	ZH-3A打点	A1501-WV03	ZH-3A	3.00	6.00
4	A1501-WV04-K	ZH-4A打点	A1501-WV04	ZH-4A	4.50	7.50
5	A1501-WV05-K	ZH-5A打点	A1501-WV05	ZH-5A	6.00	9.00
6	A1501-WV06-K	ZH-6A打点	A1501-WV06	ZH-6A	7.50	10.50
7	A1501-WV07-K	ZH-7A打点	A1501-WV07	ZH-7A	9.00	12.00
8	A1501-WV08-K	ZH-8A打点	A1501-WV08	ZH-8A	10.50	13.50
9	A1501-WV09-K	ZH-9A打点	A1501-WV09	ZH-9A	12.00	15.00
10	A1501-WV10-K	ZH-10A打点	A1501-WV10	ZH-10A	13.50	16.50
11	A1501-WV11-K	ZH-11A打点	A1501-WV11	ZH-11A	15.00	18.00
12	A1501-WV12-K	ZH-12A打点	A1501-WV12	ZH-12A	16.50	19.50
13	A1501-WV13-K	ZH-13A打点	A1501-WV13	ZH-13A	18.00	21.00
14	A1501-WV14-K	ZH-14A打点	A1501-WV14	ZH-14A	19.50	22.50
15	A1501-WV15-K	ZH-15A打点	A1501-WV15	ZH-15A	21.00	24.00
16	A1501-WV16-K	ZH-16A打点	A1501-WV16	ZH-16A	22.50	25.50

LHE® 浙江联和电子有限公司			
品名	ZH-A	比例	4:1
料号	A1501-WV	未注公差(mm)	
图号	LHE\GC-12	>0~3	±0.12
材料	Nylon 66 UL94V-0	>3~18	±0.15
制图	王天 2024-05-10	>18~50	±0.3
审核	天琴 2024-05-10	>50~120	±0.5
批准	李育文 2024-05-10	X°	±3°
视角		X.X°	±0.5°

ZH型连接器承认书图面

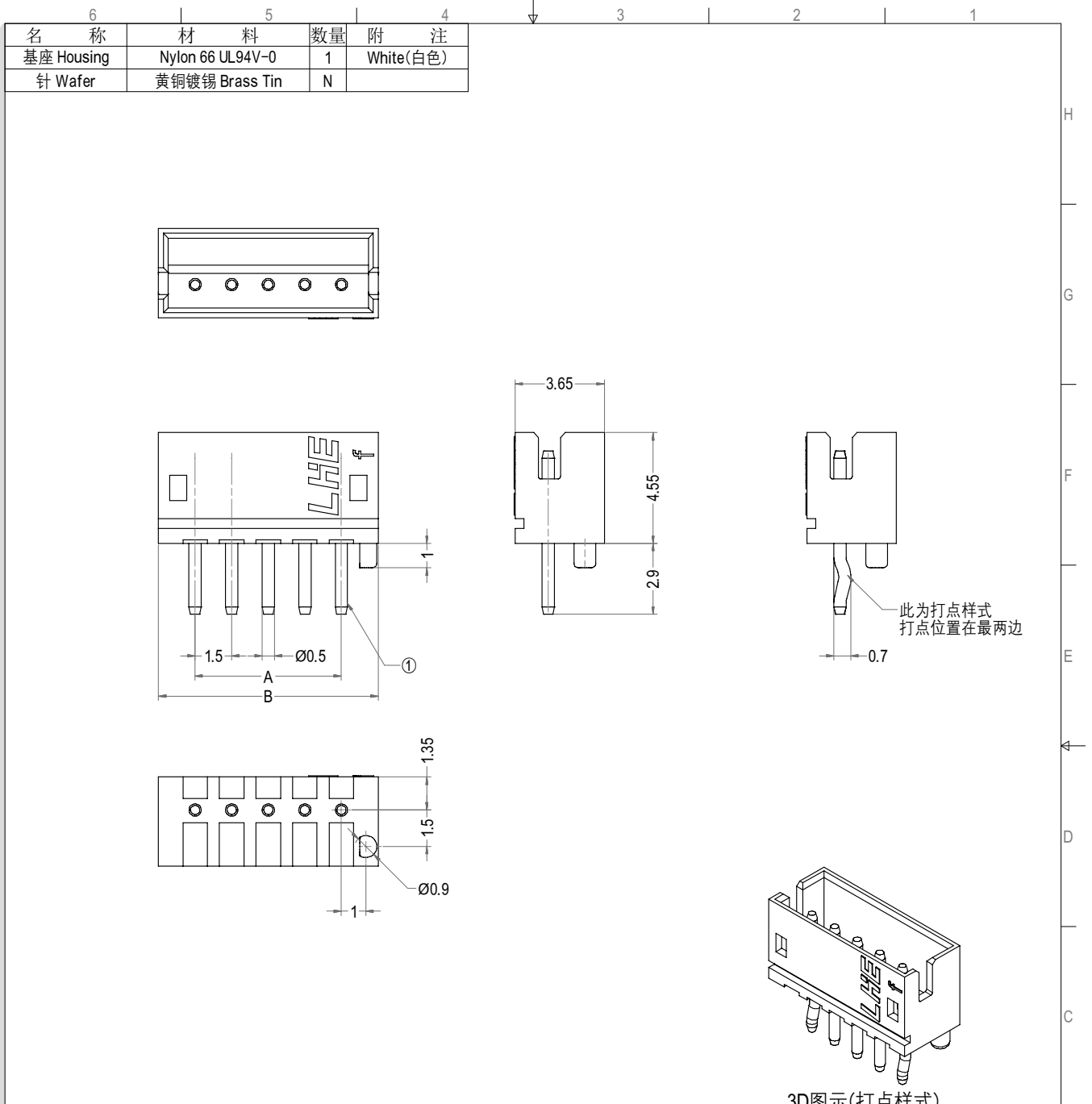

3D图示(打点样式)

Poles	Part No.1	Description 1	Part No.2	Description 2	DIM=A	DIM=B
2	A1501-DWV02-K	ZH-2AD打点	A1501-DWV02	ZH-2AD	1.50	4.50
3	A1501-DWV03-K	ZH-3AD打点	A1501-DWV03	ZH-3AD	3.00	6.00
4	A1501-DWV04-K	ZH-4AD打点	A1501-DWV04	ZH-4AD	4.50	7.50
5	A1501-DWV05-K	ZH-5AD打点	A1501-DWV05	ZH-5AD	6.00	9.00
6	A1501-DWV06-K	ZH-6AD打点	A1501-DWV06	ZH-6AD	7.50	10.50
7	A1501-DWV07-K	ZH-7AD打点	A1501-DWV07	ZH-7AD	9.00	12.00
8	A1501-DWV08-K	ZH-8AD打点	A1501-DWV08	ZH-8AD	10.50	13.50
9	A1501-DWV09-K	ZH-9AD打点	A1501-DWV09	ZH-9AD	12.00	15.00
10	A1501-DWV10-K	ZH-10AD打点	A1501-DWV10	ZH-10AD	13.50	16.50
11	A1501-DWV11-K	ZH-11AD打点	A1501-DWV11	ZH-11AD	15.00	18.00
12	A1501-DWV12-K	ZH-12AD打点	A1501-DWV12	ZH-12AD	16.50	19.50
13	A1501-DWV13-K	ZH-13AD打点	A1501-DWV13	ZH-13AD	18.00	21.00
14	A1501-DWV14-K	ZH-14AD打点	A1501-DWV14	ZH-14AD	19.50	22.50
15	A1501-DWV15-K	ZH-15AD打点	A1501-DWV15	ZH-15AD	21.00	24.00
16	A1501-DWV16-K	ZH-16AD打点	A1501-DWV16	ZH-16AD	22.50	25.50

LHE® 浙江联和电子有限公司

品名	ZH-AD	比例	4:1
料号	A1501-DWV	未注公差(mm)	
图号	LHE\GC-13	>0~3	±0.12
材料	Nylon 66 UL94V-0	>3~18	±0.15
制图	王天 2024-05-10	>18~50	±0.3
审核	天琴 2024-05-10	>50~120	±0.5
批准	李育文 2024-05-10	X°	±3°
视角		X.X°	±0.5°

ZH型连接器承认书图面



6	5	4	3	2	1
名称	材料	数量	附注		
基座 Housing	Nylon 66 UL94V-0	1	White(白色)		
针 Wafer	黄铜镀锡 Brass Tin	N			

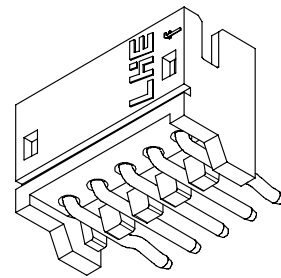
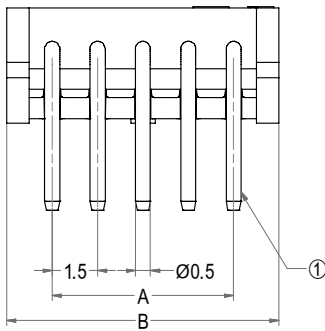
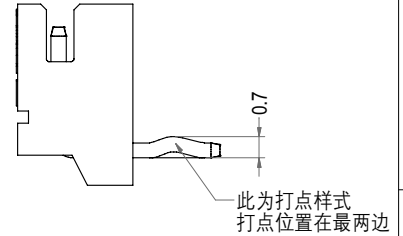
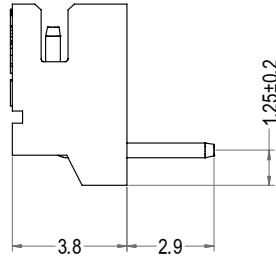
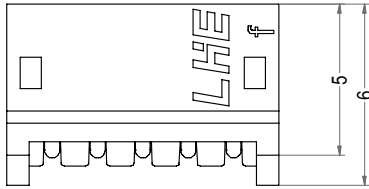
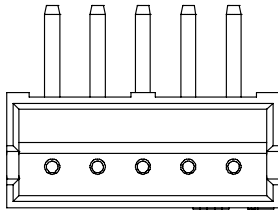

3D图示(打点样式)

Poles	Part No.1	Description 1	Part No.2	Description 2	DIM=A	DIM=B
2	A1501-WR02-K	ZH-2AWD打点	A1501-WR02	ZH-2AWD	1.50	4.50
3	A1501-WR03-K	ZH-3AWD打点	A1501-WR03	ZH-3AWD	3.00	6.00
4	A1501-WR04-K	ZH-4AWD打点	A1501-WR04	ZH-4AWD	4.50	7.50
5	A1501-WR05-K	ZH-5AWD打点	A1501-WR05	ZH-5AWD	6.00	9.00
6	A1501-WR06-K	ZH-6AWD打点	A1501-WR06	ZH-6AWD	7.50	10.50
7	A1501-WR07-K	ZH-7AWD打点	A1501-WR07	ZH-7AWD	9.00	12.00
8	A1501-WR08-K	ZH-8AWD打点	A1501-WR08	ZH-8AWD	10.50	13.50
9	A1501-WR09-K	ZH-9AWD打点	A1501-WR09	ZH-9AWD	12.00	15.00
10	A1501-WR10-K	ZH-10AWD打点	A1501-WR10	ZH-10AWD	13.50	16.50
11	A1501-WR11-K	ZH-11AWD打点	A1501-WR11	ZH-11AWD	15.00	18.00
12	A1501-WR12-K	ZH-12AWD打点	A1501-WR12	ZH-12AWD	16.50	19.50
13	A1501-WR13-K	ZH-13AWD打点	A1501-WR13	ZH-13AWD	18.00	21.00
14	A1501-WR14-K	ZH-14AWD打点	A1501-WR14	ZH-14AWD	19.50	22.50
15	A1501-WR15-K	ZH-15AWD打点	A1501-WR15	ZH-15AWD	21.00	24.00
16	A1501-WR16-K	ZH-16AWD打点	A1501-WR16	ZH-16AWD	22.50	25.50

LHE® 浙江联和电子有限公司			
品名	ZH-AWD	比例	4:1
料号	A1501-WR	未注公差(mm)	
图号	LHE\GC-14	>0~3	±0.12
材料	Nylon 66 UL94V-0	>3~18	±0.15
制图	王天 2024-05-10	>18~50	±0.3
审核	天琴 2024-05-10	>50~120	±0.5
批准	李育文 2024-05-10	X°	±3°
视角		X.X°	±0.5°

ZH型连接器承认书图面



名称	材料	数量	附注
基座 Housing	LCP	1	Beige(米黄色)
针 Wafer	黄铜 Brass Tin	N	
焊片 Solder pad	黄铜 Brass Tin	2	
CAP	LCP	1	Beige(米黄色)

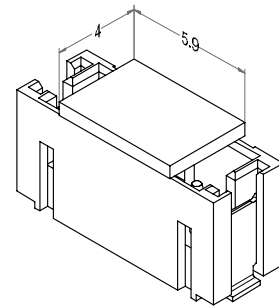
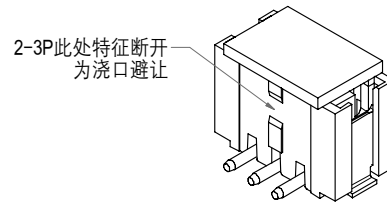
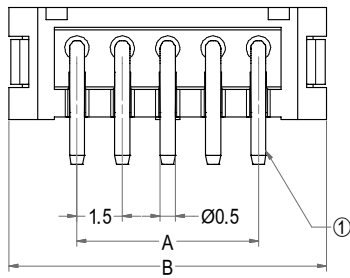
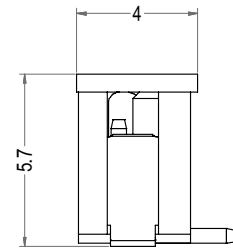
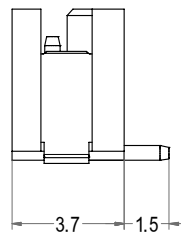
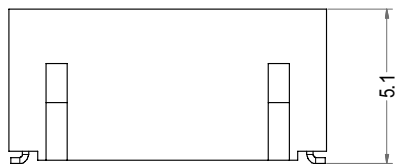

3D图示(加CAP样式)

Poles	Part No.	Description	DIM=A	DIM=B
2	A1501-SV02	ZH-2AB	1.50	6.00
3	A1501-SV03	ZH-3AB	3.00	7.50
4	A1501-SV04	ZH-4AB	4.50	9.00
5	A1501-SV05	ZH-5AB	6.00	10.50
6	A1501-SV06	ZH-6AB	7.50	12.00
7	A1501-SV07	ZH-7AB	9.00	13.50
8	A1501-SV08	ZH-8AB	10.50	15.00
9	A1501-SV09	ZH-9AB	12.00	16.50
10	A1501-SV10	ZH-10AB	13.50	18.00
11	A1501-SV11	ZH-11AB	15.00	19.50
12	A1501-SV12	ZH-12AB	16.50	21.00
13	A1501-SV13	ZH-13AB	18.00	22.50
14	A1501-SV14	ZH-14AB	19.50	24.00
15	A1501-SV15	ZH-15AB	21.00	25.50
16	A1501-SV16	ZH-16AB	22.50	27.00
17	A1501-SV17	ZH-17AB	24.00	28.50

LHE® 浙江联和电子有限公司

品名	ZH-AB	比例	4:1
料号	A1501-SV	未注公差(mm)	
图号	LHE\GC-15	>0~3	±0.12
材料	LCP	>3~18	±0.15
制图	王天 2024-05-10	>18~50	±0.3
审核	天琴 2024-05-10	>50~120	±0.5
批准	李育文 2024-05-10	X°	±3°
视角		X.X°	±0.5°

ZH型连接器承认书图面



名称	材料	数量	附注
基座 Housing	LCP	1	Beige(米黄色)
针 Wafer	黄铜 Brass Tin	N	
焊片 Solder pad	黄铜 Brass Tin	2	
CAP	LCP	1	Beige(米黄色)

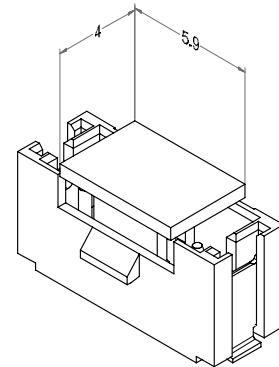
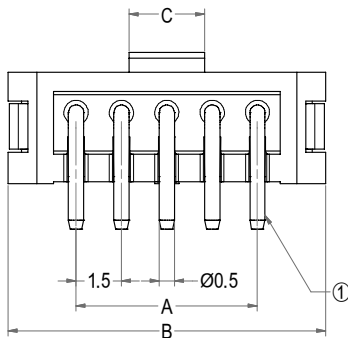
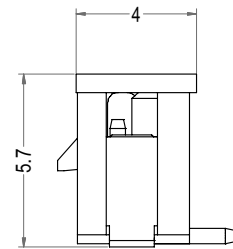
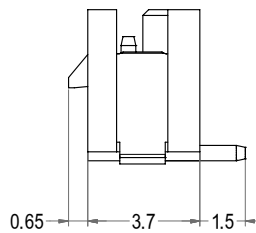
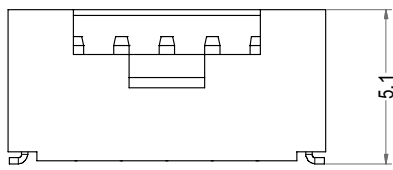

3D图示(加CAP样式)

Poles	Part No.	Description	DIM=A	DIM=B	DIM=C
2	A 1501-SVB02	ZHB-2AB	1.50	6.00	1.00
3	A 1501-SVB03	ZHB-3AB	3.00	7.50	1.00
4	A 1501-SVB04	ZHB-4AB	4.50	9.00	2.50
5	A 1501-SVB05	ZHB-5AB	6.00	10.50	2.50
6	A 1501-SVB06	ZHB-6AB	7.50	12.00	2.50
7	A 1501-SVB07	ZHB-7AB	9.00	13.50	2.50
8	A 1501-SVB08	ZHB-8AB	10.50	15.00	2.50
9	A 1501-SVB09	ZHB-9AB	12.00	16.50	2.50
10	A 1501-SVB10	ZHB-10AB	13.50	18.00	7.00
11	A 1501-SVB11	ZHB-11AB	15.00	19.50	7.00
12	A 1501-SVB12	ZHB-12AB	16.50	21.00	7.00
13	A 1501-SVB13	ZHB-13AB	18.00	22.50	7.00
14	A 1501-SVB14	ZHB-14AB	19.50	24.00	7.00
15	A 1501-SVB15	ZHB-15AB	21.00	25.50	7.00
16	A 1501-SVB16	ZHB-16AB	22.50	27.00	7.00
17	A 1501-SVB17	ZHB-17AB	24.00	28.50	7.00

LHE® 浙江联和电子有限公司			
品名	ZHB-AB	比例	4:1
料号	A1501-SVB	未注公差(mm)	
图号	LHE\GC-16	>0~3	±0.12
材料	LCP	>3~18	±0.15
制图	王天 2024-05-10	>18~50	±0.3
审核	天琴 2024-05-10	>50~120	±0.5
批准	李育文 2024-05-10	X°	±3°
视角		X.X°	±0.5°

ZH型连接器承认书图面

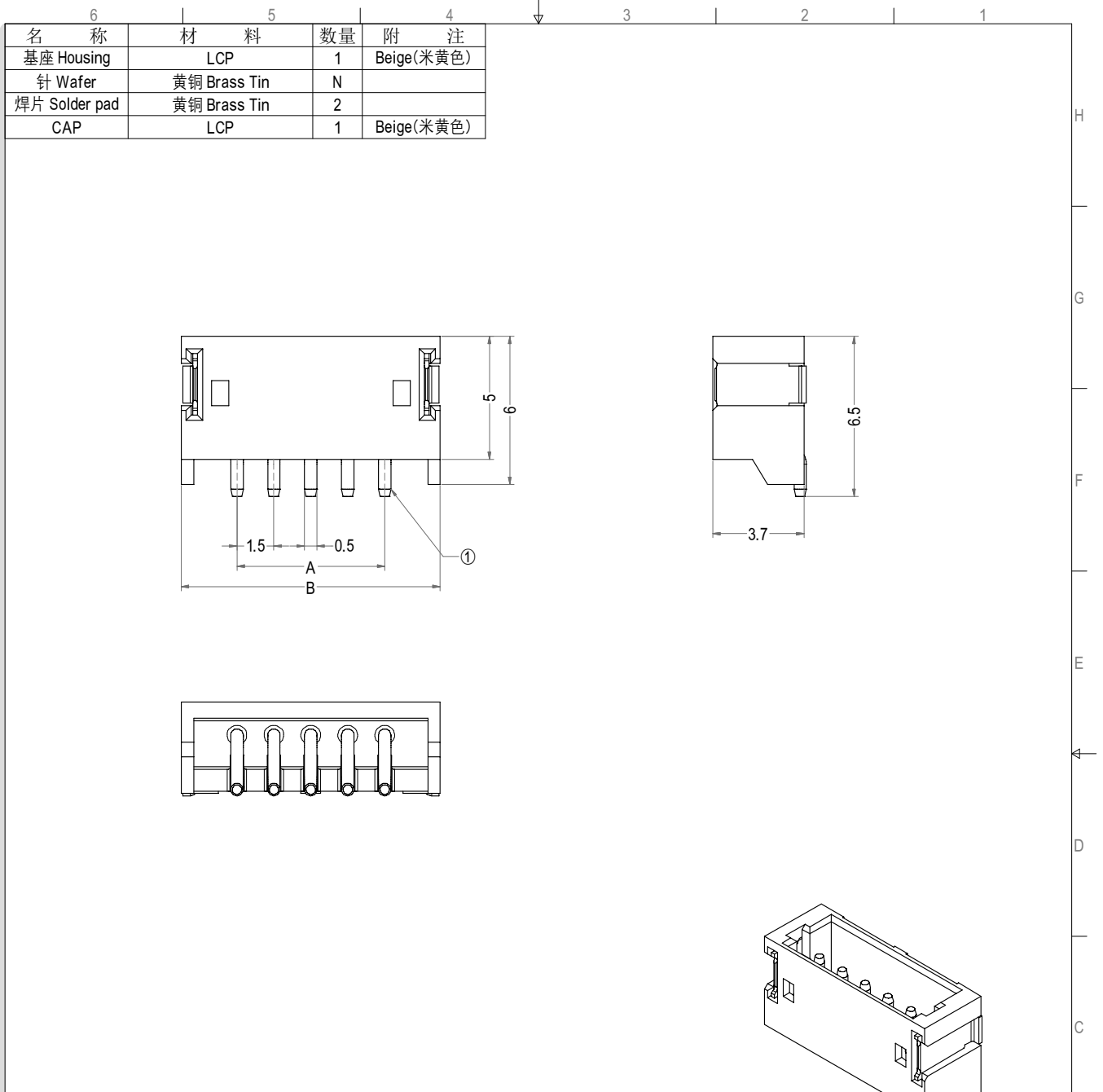

Poles	Part No.	Description	DIM=A	DIM=B
2	A1501-SR02	ZH-2AWB	1.50	6.00
3	A1501-SR03	ZH-3AWB	3.00	7.50
4	A1501-SR04	ZH-4AWB	4.50	9.00
5	A1501-SR05	ZH-5AWB	6.00	10.50
6	A1501-SR06	ZH-6AWB	7.50	12.00
7	A1501-SR07	ZH-7AWB	9.00	13.50
8	A1501-SR08	ZH-8AWB	10.50	15.00
9	A1501-SR09	ZH-9AWB	12.00	16.50
10	A1501-SR10	ZH-10AWB	13.50	18.00
11	A1501-SR11	ZH-11AWB	15.00	19.50
12	A1501-SR12	ZH-12AWB	16.50	21.00
13	A1501-SR13	ZH-13AWB	18.00	22.50
14	A1501-SR14	ZH-14AWB	19.50	24.00
15	A1501-SR15	ZH-15AWB	21.00	25.50
16	A1501-SR16	ZH-16AWB	22.50	27.00
17	A1501-SR17	ZH-17AWB	24.00	28.50

LHE® 浙江联和电子有限公司			
品名	ZH-AWB	比例	4:1
料号	A1501-SR	未注公差(mm)	
图号	LHE\GC-17	>0~3	±0.12
材料	LCP	>3~18	±0.15
制图	王天 2024-05-10	>18~50	±0.3
审核	天琴 2024-05-10	>50~120	±0.5
批准	李育文 2024-05-10	X°	±3°
视角		X.X°	±0.5°

ZH型连接器承认书图面



名称	材料	数量	附注
基座 Housing	LCP	1	Beige(米黄色)
针 Wafer	黄铜 Brass Tin	N	
焊片 Solder pad	黄铜 Brass Tin	2	
CAP	LCP	1	Beige(米黄色)

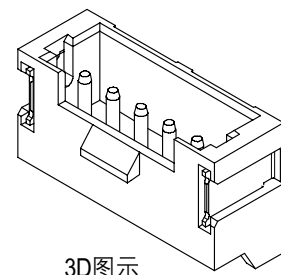
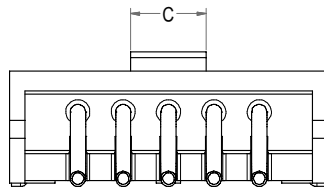
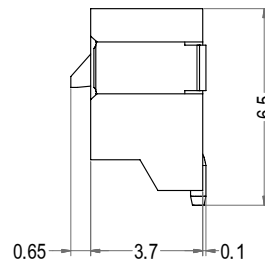
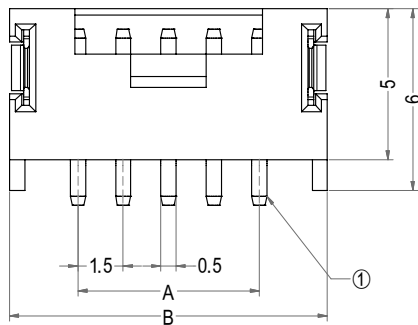

3D图示

Poles	Part No.	Description	DIM=A	DIM=B	DIM=C
2	A 1501-SRB02	ZHB-2AWB	1.50	6.00	1.00
3	A 1501-SRB03	ZHB-3AWB	3.00	7.50	1.00
4	A 1501-SRB04	ZHB-4AWB	4.50	9.00	2.50
5	A 1501-SRB05	ZHB-5AWB	6.00	10.50	2.50
6	A 1501-SRB06	ZHB-6AWB	7.50	12.00	2.50
7	A 1501-SRB07	ZHB-7AWB	9.00	13.50	2.50
8	A 1501-SRB08	ZHB-8AWB	10.50	15.00	2.50
9	A 1501-SRB09	ZHB-9AWB	12.00	16.50	2.50
10	A 1501-SRB10	ZHB-10AWB	13.50	18.00	7.00
11	A 1501-SRB11	ZHB-11AWB	15.00	19.50	7.00
12	A 1501-SRB12	ZHB-12AWB	16.50	21.00	7.00
13	A 1501-SRB13	ZHB-13AWB	18.00	22.50	7.00
14	A 1501-SRB14	ZHB-14AWB	19.50	24.00	7.00
15	A 1501-SRB15	ZHB-15AWB	21.00	25.50	7.00
16	A 1501-SRB16	ZHB-16AWB	22.50	27.00	7.00
17	A 1501-SRB17	ZHB-17AWB	24.00	28.50	7.00

LHE® 浙江联和电子有限公司			
品名	ZHB-AWB	比例	4:1
料号	A1501-SRB	未注公差(mm)	
图号	LHE\GC-18	>0~3	±0.12
材料	LCP	>3~18	±0.15
制图	王天 2024-05-10	>18~50	±0.3
审核	天琴 2024-05-10	>50~120	±0.5
批准	李育文 2024-05-10	X°	±3°
视角		X.X°	±0.5°

ZH型连接器承认书图面



6 | 5 | 4 | ↓ | 3 | 2 | 1

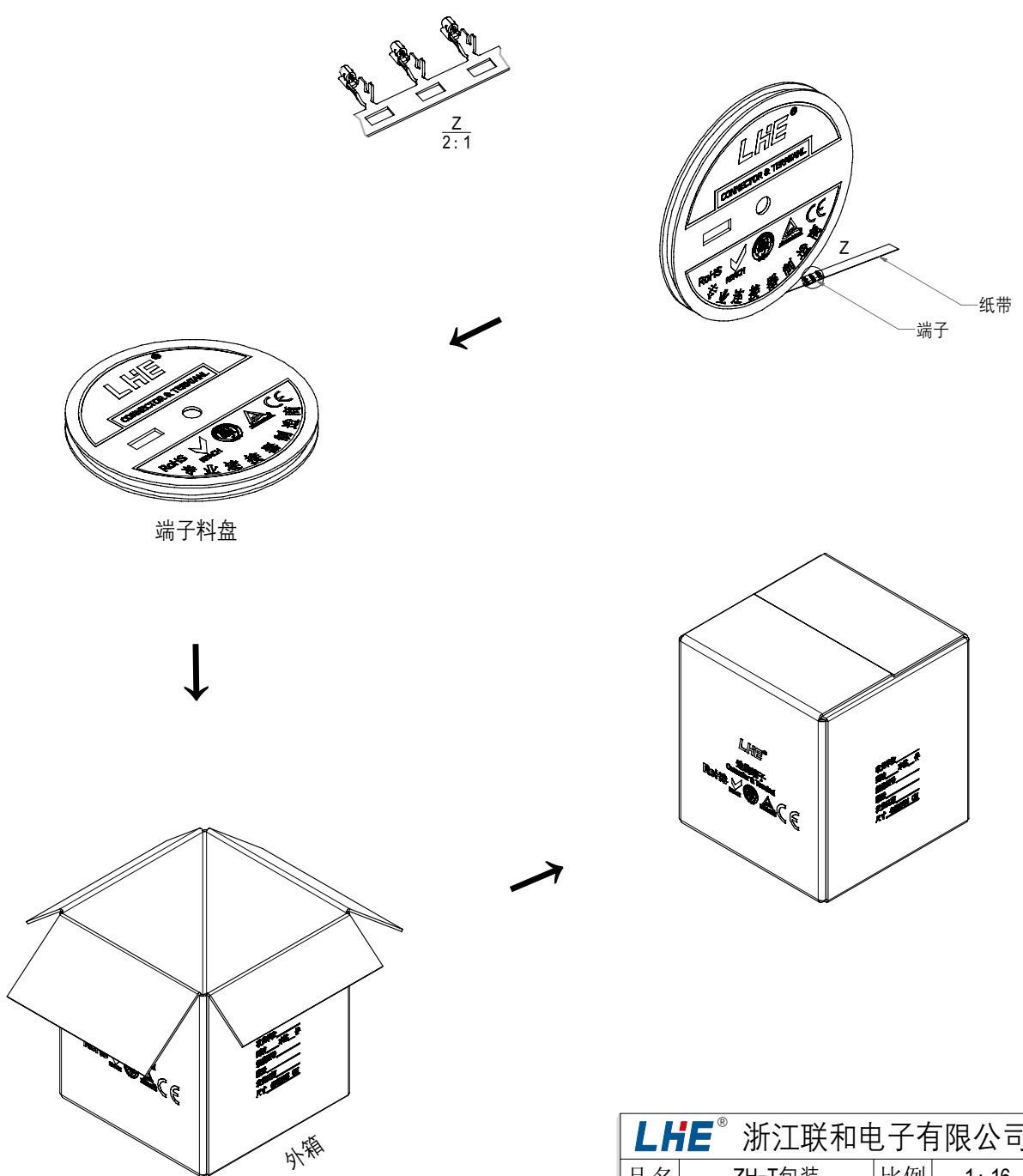

注释:

1. 产品尺寸请参照ZH-NT图纸.
2. 此示意图为产品出料方式进行说明.
3. 胶带、PE袋未在图纸中体现,请以实物为准.

Part No.	Description	Qty/reel	Reel/caton
A1501-TN	ZH-TN	11000pcs	28/Reel

LHE® 浙江联和电子有限公司

品名	ZH-T包装	比例	1:16
料号	A1501-T包装	未注公差(mm)	
图号	LHEIGC-19	>0~3	±0.12
材料	/	>3~18	±0.15
制图	王天 2024-05-10	>18~50	±0.3
审核	天琴 2024-05-10	>50~120	±0.5
批准	李育文 2024-05-10	X°	±3°
视角		X.X°	±0.5°

ZH型连接器承认书图面

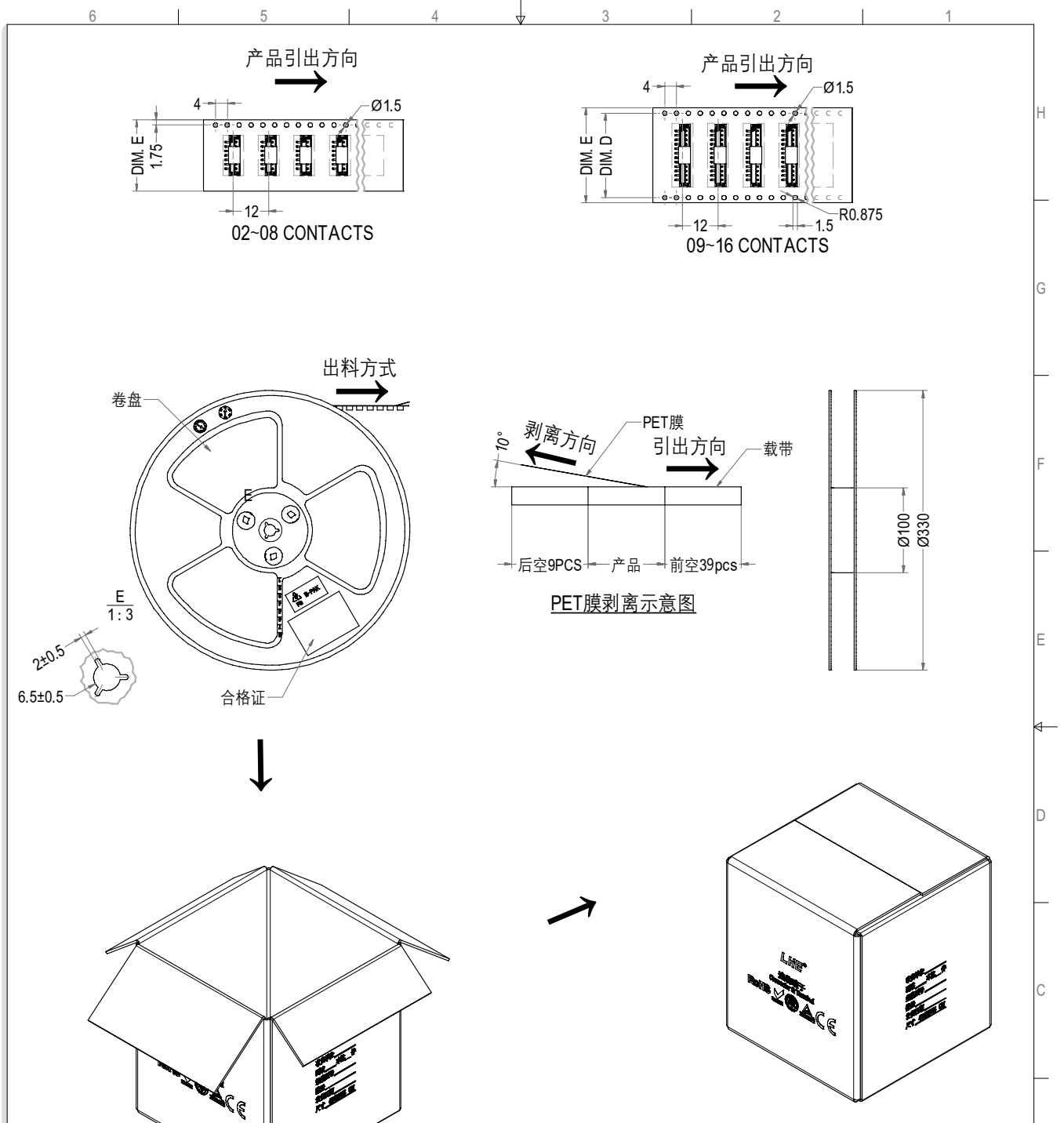

注释:

1. 产品尺寸请参照ZH-NAB图纸.
2. 此示意图为产品出料方式进行说明.
3. 胶带、PE袋未在图纸中体现,请以实物为准.

Circuits	DIM. D	DIM. E	Q'ty/Reel	Reel/Caton
02-03PIN	-	16	1000PCS	20/Reel
04-08PIN	-	24	1000PCS	15/Reel
09-12PIN	28.4	32	1000PCS	11/Reel
13PIN	40.4	44	1000PCS	8/Reel

LHE® 浙江联和电子有限公司

品名	ZH-AB包装	比例	1: 16
料号	A 1501-SV包装	未注公差(mm)	
图号	LHEIGC-20	>0~3	±0.12
材料	/	>3~18	±0.15
制图	王天2024-05-10	>18~50	±0.3
审核	天琴2024-05-10	>50~120	±0.5
批准	李育文2024-05-10	X°	±3°
视角		X.X°	±0.5°

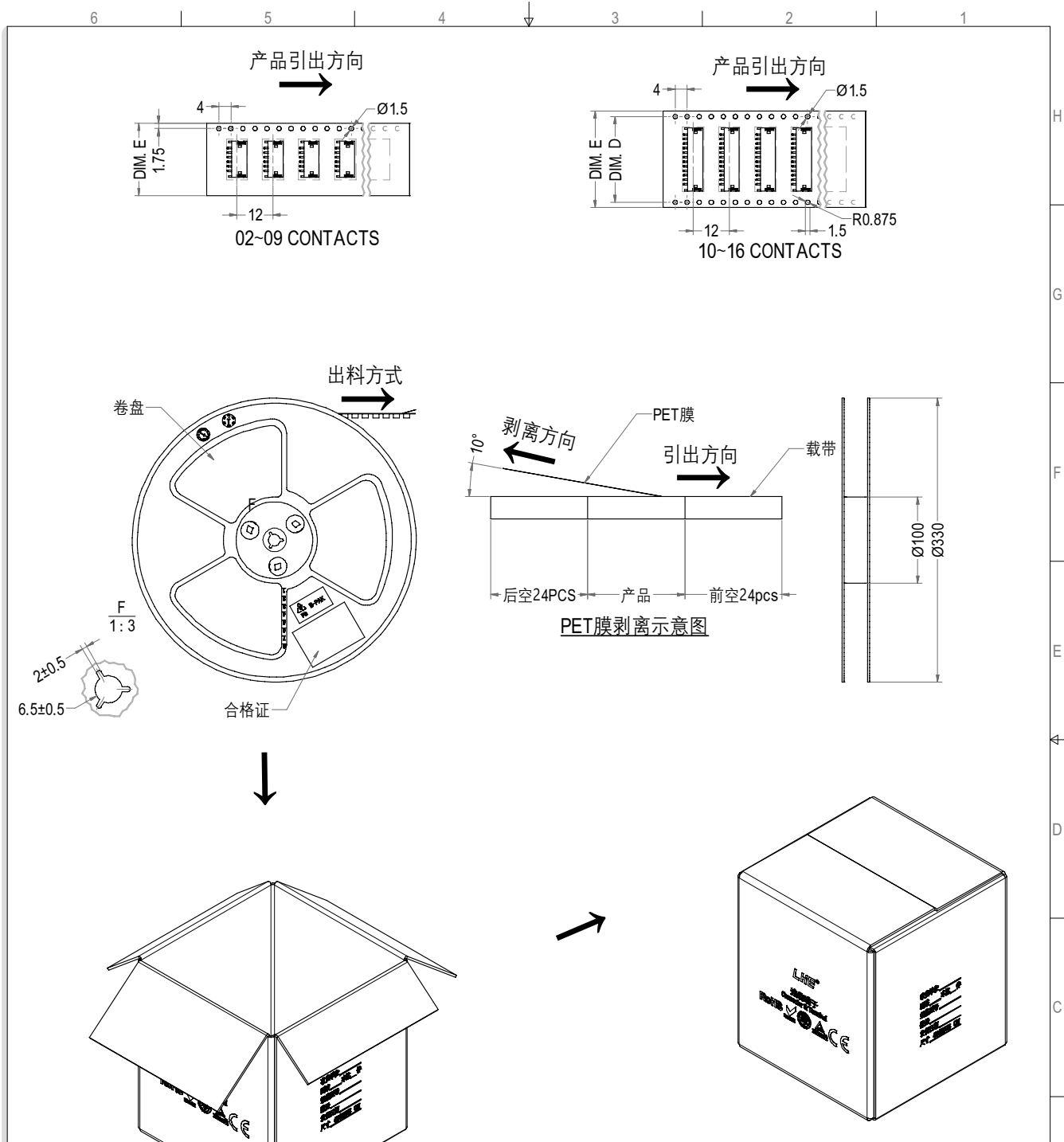

注释:

1. 产品尺寸请参照ZH-NAWB图纸.
2. 此示意图为产品出料方式进行说明.
3. 胶带、PE袋未在图纸中体现,请以实物为准.

Circuits	DIM. D	DIM. E	Q'ty/Reel	Reel/Caton
02-03PIN	-	16	1000PCS	20/Reel
04-09PIN	-	24	1000PCS	15/Reel
10-11PIN	28.4	32	1000PCS	11/Reel
12-13PIN	52.4	56	1000PCS	8/Reel

LHE® 浙江联和电子有限公司			
品名	ZH-AWB包装	比例	1:16
料号	A1501-SR包装	未注公差(mm)	
图号	LHEIGC-21	>0-3	±0.12
材料	/	>3-18	±0.15
制图	王天 2024-05-10	>18-50	±0.3
审核	天琴 2024-05-10	>50-120	±0.5
批准	李育文 2024-05-10	X°	±3°
视角		X.X°	±0.5°

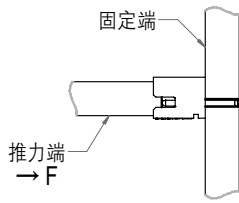
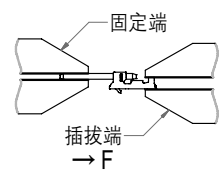
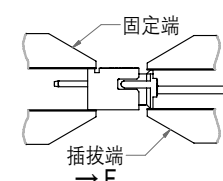
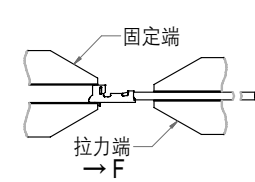
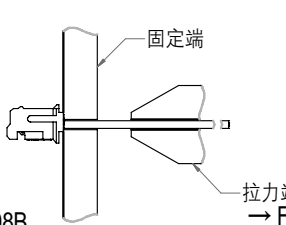
项目 Item	测试条件 Test Condition	规格要求 Requirement		
<p>1.外观 Appearance</p>	<p>目测 Visual by eye 视力 Light: >1.0 照明 Lamp: 200~300Lx 目测距离 Space: 0.3~0.5m GB/T 5095.1 Method 1a</p>	<p>1.塑料件表面应无明显疤痕、凹陷、开裂及影响使用的变形。 Plastic part:smooth and flat surface without discolor,broken,crack distortion defects is acceptable. 2.金属件表面无锈蚀、氧化、无明显机械损伤等缺陷。 Metal part:btight and even surface without rust,oxide,fog and obvious physical damage defects is acceptable. 3.导线表面清洁、无破损等缺陷,印字及标志清晰。 Wire:clearing surface without discolor,broken defects,indistinct words and mark is acceptable.</p>		
<p>2.壳体/端子固定力 Terminal/Housing Retention Force</p>	<p>固定连接器或测力计,在连接器轴线方向施加规定的拉力; 速度不大于25mm/min。 Apply axial pull out force at the speed rate of not more 25mm/min on the pin assembled in the housing. GB/T 5095.8 Method 15d/EIA-364-29B</p> 	<p>≥ 10N</p>		
<p>3.插入力与拔出力 Insertion and Withdrawal Force</p>	<p>单PIN相配的接触器以1mm/s~5mm/s的速度沿接插器轴线方向插入和拔出。 Insertion and withdraw single contact at the speed rate of 1mm/s~5mm/s.</p>  <p>相配的连接器的以1mm/s~5mm/s的速度沿接插器轴线方向插入和拔出。 Insertion and withdraw connectors at the speed rate of 1mm/s~5mm/s. GB/T 5095.7 Method 13b/EIA-364-13B</p> 	<p>极数 Poles</p>	<p>插入力(最大值N) Insertion(N Max)</p>	<p>拔出力(最小值N) Withdrawal(N Min)</p>
		<p>1</p>	<p>7.0</p>	<p>1.0</p>
<p>4.针的固定力 Pin Retention Force</p>	<p>固定连接器或测力计,在连接器轴线方向对针施加规定的推力; 速度不大于25mm/min。 Apply axial push out force at the speed rate of not more 25mm/minute on the terminal assembled in the base. GB/T 5095.8 Method 15a/ EIA-364-29B</p> 	<p>≥ 10N</p>		
<p>5.压着部位抗拉强度 Crimping Pull Out Force</p>	<p>在试验装置夹头中固定测试样品,在连接的轴线方向施加拉力; 速度不大于25mm/min。 Fix the crimped terminal, apply axial pull out force on the wire at the speed rate of not more 25mm/min. GB/T5095.8 Method 16d/EIA-364-08B</p> 	<p>AWG.26#</p>	<p>≥ 20N</p>	
		<p>AWG.28#</p>	<p>≥ 10N</p>	
		<p>AWG.30#</p>	<p>≥ 8N</p>	
		<p>AWG.32#</p>	<p>≥ 5N</p>	

项目 Item	测试条件 Test Condition	规格要求 Requirement	
6. 机械振动 Vibration	插合连接器, 串联在一直流电源上, 电流 100mA; 并模拟正常工作状态, 振频为 10~55Hz、振幅 1.5mm; 每一轴线扫频循环次数 10 次、2 小时。 Frequency: 10~55Hz Amplitude: ±1.5mm Duration: 2 hours in each X,Y,Z axes GB/T 5095.4 Method 6d/EIA-364-28D	外观 Appearance	无损伤 No Damage
		接触电阻 Contact Resistance LLCR	≤ 30mΩ
7. 机械冲击 Shock	连接器相配, 沿 X, Y, Z 三轴正反方向各冲击 3 次(总共 18 次), 在测试过程中通以 100mA 电流。 冲击强度: 490m/s ² 持续时间: 11ms Mated connectors and subject to the following shock conditions, 3 times of shock shall be applied for each 6 directions along 3 mutually perpendicular axes, passing DC 100mA current during the test (Total of 18 shocks) Test Pulse: Half Sine Peak Value: 490m/s ² Duration: 11ms GB/T 5095.4 Method 6c/EIA-364-27B	中断 Intermittence	≤ 1μ sec
		接触电阻 Contact Resistance LLCR	≤ 30mΩ
8. 机械寿命 Repeated insertion/withdrawal	以每分钟插拔 10 次的速率, 插拔 50 次。 When mated up to 50 cycles repeatedly by the rate of 10 cycles per minute. GB/T 5095.5 Method 9a/EIA-364-09C	外观 Appearance	无损伤 No Damage
		接触电阻 Contact Resistance LLCR	≤ 30mΩ
9. 接触电阻 Contact Resistance	插合连接器, 用小功率电路进行测试。 Mate connectors, measure by dry circuit. GB/T 5095.2 Method 2a/EIA-364-23B	≤ 20mΩ	
10. 绝缘电阻 Insulation Resistance	在相邻接触件之间或地线之间, 用 500V DC 电压进行测试。 Apply 500V DC between adjacent terminal or ground. GB/T 5095.2 Method 3a/EIA-364-21C	≥ 500MΩ	
11. 耐电压 Dielectric Strength	相邻接触件之间或地线之间施加 50Hz 500V AC (有效值), 漏电流 1mA 的电压作用, 时间 1min。 Mate connectors, apply 500V AC for 1 minute between adjacent terminal or ground. GB/T 5095.2 Method 4a/EIA-364-20B	无击穿和飞弧现象 No Breakdown	
12. 温度上升 Temperature Rise	插合连接器, 通以最大允许电流。 GB/T 5095.3 Method 5a/EIA-364-70A	温度最大上升 Temperature Rise	≤ 30°C
13. 耐高温 Heat Resistance	连接器配合后, 于 +105°C ± 2°C 的空气中放置 96 小时, 然后再回到 室温中放置 1~2 小时测定 Mated connectors are exposed to a temperature of +105°C ± 2°C for 96 hours. GB/T 5095.6 Method 11i /EIA-364-17B	外观 Appearance	无损伤 No Damage
14. 耐低温 Clod Resistance	连接器配合后, 于 -25°C ± 2°C 的空气中放置 96 小时, 然后再回到 室温中放置 1~2 小时测定 Mated connectors are exposed to a temperature of -25°C ± 2°C for 96 hours. GB/T 5095.6 Method 11i /EIA-364-17B	接触电阻 Contact Resistance LLCR	≤ 30mΩ

项目 Item	测试条件 Test Condition	规格要求 Requirement	
15. 恒定湿热 Humidity	温度 Temperature: 40±2°C 相对湿度 Relative Humidity: 90%~95% 搁置时间 Duration: 96h, 取出恢复2小时后检查 GB/T 5095.6 Method 11c/EIA-364-31B	外观 Appearance	无损伤 No Damage
		耐电压 Dielectric Strength	500V
16. 温度循环 Temperature cycle	把测试样品放入高低温试验箱中,按下列步骤调试温度: a)在-25°C±2°C的恒温条件下放置0.5小时; b)在+105°C±2°C的恒温条件下放置0.5小时; 从a)到b)为一个循环周期,共进行5个循环。恢复1h后检查。 状态转换时间不多于1小时。 Mated connectors are exposed to 5 cycles of: a)-25°C±2°C 0.5hour b)+105°C±2°C 0.5hour GB/T 5095.6 method 11d/EIA-364-32C	绝缘电阻 Insulation Resistance	≥500MΩ
		接触电阻 Contact Resistance LLCR	≤30mΩ
17. 盐雾 Salt Spray	把先冲后镀*的测试样品从试验箱顶悬挂下来,采用浓度为5%±1(质量百分比)的氯化钠溶液,连续雾化24小时,试验后用流动的蒸馏水轻轻洗去表面沉积物。在常温常驻湿条件下恢复1~2小时。 24 hour exposure to a saltspray from the 5%±1 solution. GB/T 5095.6 Method 11f/EIA-364-26B	外观无损伤(五金件应无露出底金属的严重锈蚀;使用预镀的型材,其落料面允许有不影响其性能的轻微腐蚀。) Appearance:No Damage(No erosion with material exposed. And with plating material,slight erosion on the cutting surface acceptable)	
18. 可焊性 Solderability	把测试样品需要焊接的部位浸入焊锡炉中(锡炉温度235°C±5°C)2±0.5秒钟。 Soldering time: 2±0.5 sec Solder Temperature:235°C±5°C GB/T 5095.6 Method 12a/EIA-364-52	上锡率≥90% 90% of immersed area must show no voids,pin holes	
19. 耐焊接热 Resistance to Soldering Heat	把测试样品需要焊接的部位浸入焊锡炉中(锡炉温度260°C±5°C);5±1秒钟后,在正常的条件下恢复1小时。 Soldering time: 5±1 sec Solder Temperature:260°C±5°C GB/T 5095.6 Method 12d/EIA-364-56A	外观 Appearance	无损伤 No Damage
20. 灼热丝测试 Glow Wire (只针对GWT750°C产品 Only for GWT750°C products)	750C灼热丝顶部接触试验样品,接触时间:(30±1) s 接近和离开速率: 10mm/s~25mm/s 灼热丝进入或贯穿试验样品深度:(7±0.5) mm 750°C elow wire contacts with mated connector. Time: (30+1) s Speed of closing to and leaving: 10mm/s-25mm's Depth that glow wire penetrates mated connector: (7-05 mm GB/T 5169.10	1.试验样品燃烧时间不超过2s。 The time that mated connector burns is not more than 2s. 2、灼热丝离开后的30s内样件无火焰或灼热情况,且无滴落物或滴落物不燃烧。 30s after glow wire leaves mated connector, it does not burn or is no incandescence and it does not fall something or falling something does not burn.	
21. 耐酸性(二氧化硫) Acid resistance(SO ₂)	连接器闭合连接,3±1ppm, 40±2°C.96 小时 Mated connector,3±1ppm,40±2°C Duration 96hours GB/T2423.51	接触电阻 Contact Resistance LLCR	≤30mΩ

项目 Item	测试条件 Test Condition	规格要求 Requirement	
22.氨气测试 Ammonia test	连接器闭合连接，放置于浓度为 25 mL/L 的 3% 的 NH ₃ 的空气中 7 小时 Mated connector is put into atmosphere that rated 25 ml/L of 3% NH ₃ for 7 hours GB/T2423.51	接触电阻 Contact Resistance LLCR	≤ 30mΩ

* 先冲后镀为定制端子。常规端子为先镀后冲, 无法通过盐雾试验。

制订 Edit: 王夫

日期 DATE: 2024-05-10

审核 Check: 天琴

日期 DATE: 2024-05-10

批准 Approval: 季育文

日期 DATE: 2024-05-10

无铅回流焊要求 Pb-free reflow profile requirements

参数 Parameter	参考 Reference	规格 Specification
平均温度梯度预热 Average Temperature Gradient Preheating		2.5°C/s
浸泡时间 Soak time	tsoak 2-3	minutes
150°C以上时间 Time above 150°C	T1	60s
180°C以上时间 Time above 180°C	T2	50s
250°C以上时间 Time above 250°C	T3	2±0.5s
焊接温度 Peak temperature in reflow	Tpeak	255°C(-0/+5°C)
温度梯度的冷却 Temperature gradient in cooling		Max -5°C/s

温度条件图 TEMPERATURE CONDITION GRAPH

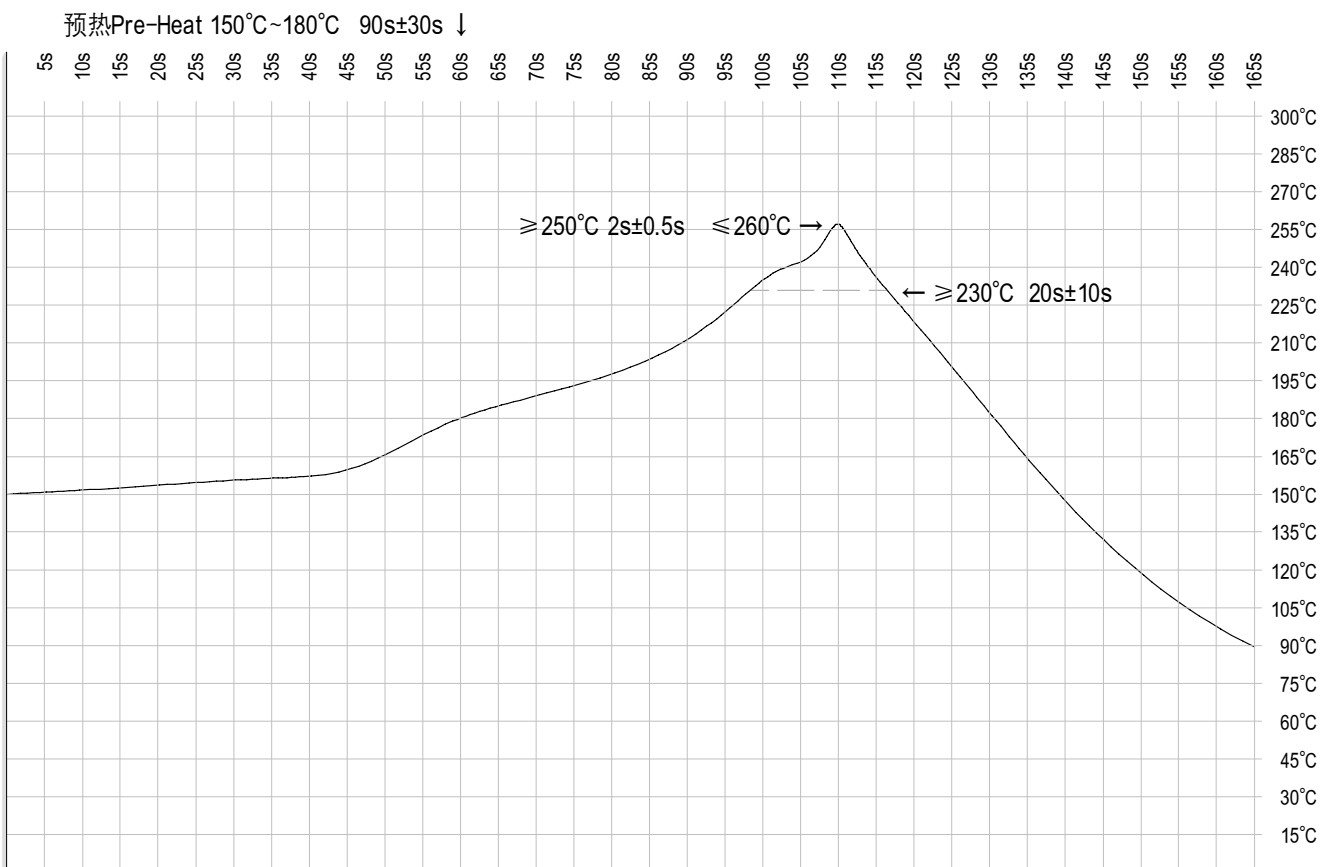

注: 对耐热性的最低要求, 是在回流焊中使用空气对流的传热方法评估焊接部件。该曲线图表明需要达到规定的空气温度, 而实际过程很大程度上取决于回流焊装置。

Note: The minimum required heat resistance of the section is to evaluate the welded components. Heat transfer method is used for hot air convection in reflow welding. The actual air temperature used to achieve the specified profile depends largely on the reflow device.

LHE 浙江联和电子有限公司

产品性能测试报告



品名 (DESCRIPTION)	ZH	测定者 (Inspector)		测定条件 (Test Condition)	温度: 22℃ (Temperature)			
料号 (MODEL NO.)	A1501	日期 (Date)	2023.11.27		湿度: 65% (Humidity)			
试验项目 (Test Title)	规格 (Specification)		测定值(Data)					COM
			X1	X2	X3	X4	X5	
带线胶壳与针座插拔力 <带锁扣> (Connector assemble with cable and wafer, mating and unmating force with latch)	2 pin Unit: N Mating force 19 max. Unmating force 5 min.	插入(Mating)	14.2	15.8	15.5	14.5	14.8	ok
		拔出(Unmating)	9.3	8.8	10.5	10.3	9.6	ok
	8 pin Unit: N Mating force 61 max. Unmating force 11 min.	插入(Mating)	47.5	48.1	44.5	46	48.5	ok
		拔出(Unmating)	21.5	20.5	23.	22	22.5	ok
带线胶壳与针座插拔力 (Connector assemble with cable and wafer mating and unmating force)	5 pin Unit: N Mating force 35 max. Unmating force 5 min.	插入(Mating)	21.9	22.4	22.5	22.3	22.7	ok
		拔出(Unmating)	20.4	19.7	19.8	20.6	20	ok
端子和胶壳的固定力 (Terminal Retention in housing)	10N Min		15.5	14.5	14	14.75	15.25	ok
端子和插针单独插入力 (Single terminal and PIN withdrawal force)	7N Max		4.25	3.75	3.5	3.75	4	ok
端子和插针单独拔出力 (Single terminal and PIN withdrawal force)	1N Min		2.25	2	2.5	2	1.75	ok
插针和壳体的固定力 (PIN Retention in insulator)	10N Min		18.5	16.5	17	20	17.5	ok
焊接后插针和壳体的固定力 (Fixation force of the pin and housing after welding)	3N Min		3.3	3.9	4.2	4	4.3	ok
盐雾试验 (Salt spray)	雾化16小时, 后镀端子不能有腐蚀现象 (Spray time:16 hours, terminals stamping then plating must not corrode)		PASS	PASS	PASS	PASS	PASS	ok
	接触电阻 (Contact Resistance)	30mΩ Max	14.7	12.2	15.4	13.9	13.5	ok
盐雾试验 (Salt spray)	雾化24小时, 插针不能有腐蚀现象 (Spray time:24 hours, PINs must not corrode)		PASS	PASS	PASS	PASS	PASS	ok
	接触电阻 (Contact Resistance)	30mΩ Max	13.1	14.5	12.8	13.9	13.5	ok
温度循环 (Temperature cycling)	外观 (Appearance)	无损伤 (No damage)	PASS	PASS	PASS	PASS	PASS	ok
	接触电阻 (Contact Resistance)	30mΩ Max	12.9	13.8	14.2	13.6	12.7	ok
	绝缘电阻 (Insulation Resistance)	500MΩ Min	PASS	PASS	PASS	PASS	PASS	ok
	耐电压 (Dielectric Withstanding Voltage)	500V,AC/minute	PASS	PASS	PASS	PASS	PASS	ok

LHE® 浙江联和电子有限公司
ZHEJIANG LIANHE ELECTRONICS CO.,LTD.

可靠性试验报告
RELIABILITY TEST REPORT

日期: 2022-03-27

针焰实验(Needle flame experiment)

测试目的(Test Purposes)	确定AB11069W-S16-10产品在针焰条件下是否符合标准要求 Determine if the AB11069W-S16-10 Does the product meet the standard requirements under the condition of needle flame						
测试条件(Test Conditions)	温度35±2℃ Temperature 35 ± 2 ℃;						
测试方法(Test Method)	对产品施加试验火焰持续时间为12s。火焰高度12mm±1mm The test flame was applied to the product for 12 s. Flame height 12 mm ± 1 mm						
参照标准(With Reference to)	GB/T5169.5-2008						
判定标准(Test Standard)	a. 试验样品无火焰和灼热, 并且规定的铺底层或包装绢纸没有起燃 b. 在移开针焰后, 试验样品和周围的零部件的火焰或灼热在30s之内熄灭, 即tb<30s, 而且周围的零部件没有完全烧毁, 以及规定的铺底层或包装绢纸没有起燃。 a. The test sample has no flame and heat, and the specified bedding or wrapping paper does not ignite b. After removing the needle flame, the flame or burning heat of the test sample and the surrounding parts will be extinguished within 30s, i.e. TB < 30s, and the surrounding parts are not completely burnt out, and the specified underlay or wrapping silk paper does not ignite						
测试设备(Test Equipment)	针焰试验机 Needle flame testing machine						
测试程序 (Test Program)	外观检验→固定样品→试验启动 →观察→记录起火时间						
测试结果 (The test results)	测试图片Test Picture						
							
	项次 Items	1	2	3	4	5	备注
	第一组 group1	无起燃	无起燃	无起燃	无起燃	无起燃	/
	第二组 group2	无起燃	无起燃	无起燃	无起燃	无起燃	/
结果results	OK	OK	OK	OK	OK	/	
结果判定 (The results determine)	样品数量 The Number of Samples 8PCS		合格数 The Number of competency			10	结果Results OK
			不合格数Unqualified			0	
			外观Appearances			OK	

核准 (Approved) : 陈浙海

测试人 (Testing Person) : 玉夫

LHE[®] 浙江联和电子有限公司 ZHEJIANG LIANHE ELECTRONICS CO., LTD.

可靠性试验报告

RELIABILITY TEST REPORT

日期: 2025-02-12

灼热丝实验(Glow wire experiment)

测试目的 (Test Purposes)	确定AB11069W-S16-10灼热丝材料产品在灼热丝条件下是否符合标准要求 Determine if the AB11069W-S16-10 Does the product meet the standard requirements under the condition of glow wire								
测试条件 (Test Conditions)	灼热丝起燃温度 (GWIT) 记录值为起始温度加 25K (对于 900℃ 和 930℃ 则是 30K, 960℃ 记为 GWIT: >960/厚度) Gwire ignition temperature (GWIT) recorded value is the starting temperature plus 25K (for 900℃ and 930℃ is 30K, 960℃ is GWIT: >960 / thickness)								
测试方法 (Test Method)	施加试验火焰持续时间为 30s。试验温度 750℃ The test flame duration was 30 s. Test temperature: 750 °C								
参照标准 (With Reference to)	根据 GB/T 5169.12-2006 及 GB/T 5169.13-2013 执行。								
判定标准 (Test Standard)	试验样条无火焰, 并且规定的铺底层或包装绢纸没有起燃。 The test sample has no flame and heat, and the specified bedding or wrapping paper does not ignite								
测试设备 (Test Equipment)	灼热丝测试仪 Glow-wire tester								
测试程序 (Test Program)	外观检验 → 固定样条 → 试验启动 → 观察 → 记录起火时间								
测试结果 (The test results)	测试图片 Test Picture								
									
	材料规格	试片尺寸 (长 X 宽 X 厚) 单位: mm	起始温度 (°C)	样品	起燃时间 (Ti) 单位: 秒	熄灭时间 (Te)	现象记录	GWIT	GWFI
								判定: PASS 或 FAIL	
	A66V0 002	60X60X2.5	750	第1个 第2个 第3个	不起燃 不起燃 不起燃	/ / /	不起燃, 无滴落 不起燃, 无滴落 不起燃, 无滴落	PASS (GWIT: 775/2.5)	PASS (GWFI: 750/2.5)
	A66V0 002	60X60X2.5	800	第1个 第2个 第3个	6 5 6	32 31 33	接触后很快就起燃, 熔融但无滴落, 起燃后 32S 熄灭 接触后很快就起燃, 熔融但无滴落, 起燃后 28S 熄灭 接触后很快就起燃, 熔融但无滴落, 起燃后 33S 熄灭	FALL	PASS (GWFI: 800/2.5)
	A66V0 002	60X60X2.5	850	第1个 第2个 第3个	2 1 2	47 53 51	接触后很快就起燃, 熔融但无滴落, 起燃后 46S 熄灭 接触后很快就起燃, 熔融但无滴落, 起燃后 51S 熄灭 接触后很快就起燃, 熔融但无滴落, 起燃后 52S 熄灭	FALL	PASS (GWFI: 850/2.5)
	A66V0 002	60X60X2.5	960	第1个 第2个 第3个	1 1 1	51 52 49	接触后很快就起燃, 熔融但无滴落, 起燃后 50S 熄灭 接触后很快就起燃, 熔融但无滴落, 起燃后 51S 熄灭 接触后很快就起燃, 熔融但无滴落, 起燃后 50S 熄灭	FALL	PASS (GWFI: 960/2.5)
	测试须知 (The test requirements)	1. 灼热丝起燃温度 (GWIT) 记录值为起始温度加 25K (对于 900℃ 和 930℃ 则是 30K, 960℃ 记为 GWIT: >960/厚度); 2. 产品在移开灼热丝之后持续燃烧的时间 ≤ 30s, 即 Te ≤ Ta (施加时间) + 30s, 并且包装绢纸没有起燃, 则灼热丝可燃性指数 (GWFI) 即为 PASS, 记录为 GWFI: 温度/厚度; 3. 本实验灼热丝 Ta (施加时间) 为 30S, 则 Te ≤ 60S 4. 如果 3 个其中有 1 个不合格则最终结果为不合格: .							

核准 (Approved) : 陈浙海

测试人 (Testing Person) : 玉夫



Component - Plastics

File Number: E331274

Celanese (Suzhou) Engineering Plastics Co Ltd
N. 155 Song Bei Road, Suzhou Industrial Park, Suzhou Jiangsu 215024 CN



FRIANYL: A3 RV0 (a)(b)(f2)

Polyamide 66 (PA66), pellets, unfilled

(a) - Virgin and regrind up to 50% by weight inclusive, have the same basic material characteristics.

(b) - Virgin and regrind up to 100% by weight inclusive, have the same basic characteristics with respect to flammability.

(f2) - Subjected to one or more of the following tests: Ultraviolet Light, Water Exposure or Immersion in accordance with UL 746C, where the acceptability for outdoor use is to be determined by UL.

Flammability	Value	Test Method
Flame Rating		UL 94
0.25 mm, ALL	V-0	IEC 60695-11-10, -20
0.38 mm, ALL	V-0	
0.75 mm, ALL	V-0	
1.5 mm, ALL	V-0	
3.0 mm, ALL	V-0	
Glow Wire Flammability Index		IEC 60695-2-12
0.75 mm	960 °C	
1.5 mm	960 °C	
3.0 mm	960 °C	
Glow Wire Ignition Temperature		IEC 60695-2-13
0.75 mm	775 °C	
1.5 mm	775 °C	
3.0 mm	775 °C	
Electrical	Value	Test Method
Hot-wire Ignition (HWI)		UL 746
0.25 mm	PLC 4	
0.38 mm	PLC 4	
0.75 mm	PLC 4	
1.5 mm	PLC 4	
3.0 mm	PLC 3	
High Amp Arc Ignition (HAI)		UL 746
0.25 mm	PLC 1	
0.38 mm	PLC 1	
0.75 mm	PLC 0	
1.5 mm	PLC 0	
3.0 mm	PLC 0	
Comparative Tracking Index (CTI)	PLC 0	UL 746
Dielectric Strength	25 kV/mm	ASTM D149 IEC 60243-1
High Voltage Arc Tracking Rate (HVTR)	PLC 0	UL 746
Inclined-Plane Tracking (1.0 kV)	60 min	ASTM D2303
Volume Resistivity	1.0E+13 ohms-cm	ASTM D257 IEC 60093
Arc Resistance	PLC 5	ASTM D495

Component - Plastics

File Number: E331274



Thermal	Value	Test Method
RTI Elec		UL 746
0.25 mm	85.0 °C	
0.38 mm	130 °C	
0.75 mm	130 °C	
1.5 mm	130 °C	
3.0 mm	130 °C	
RTI Imp		UL 746
0.25 mm	85.0 °C	
0.38 mm	105 °C	
0.75 mm	105 °C	
1.5 mm	105 °C	
3.0 mm	105 °C	
RTI Str		UL 746
0.25 mm	85.0 °C	
0.38 mm	115 °C	
0.75 mm	120 °C	
1.5 mm	120 °C	
3.0 mm	120 °C	
Physical	Value	Test Method
Dimensional Stability	0.0 %	ASTM D1042 ISO 2796
Outdoor Suitability	12	UL 746C

Notice of Disclaimer

By accessing this Yellow Card data information sheet and the database from which this information was generated (the "Yellow Card"), the user acknowledges and accepts the terms and conditions upon which this Yellow Card is made available. This Yellow Card, the database from which it was generated, and all related materials, support, and services, are made available by UL for use only by permission and "as is", without any representation or warranty of any kind, express or implied, including but not limited to any implied warranties of merchantability, fitness for a particular purpose or that the products identified in this Yellow Card will satisfy the user's requirements. UL cannot and does not warrant that the data contained in this Yellow Card is current, accurate, or complete. The user must independently confirm the conformance of any product to the applicable standards or requirements with the manufacturer of that product. Permission to access this Yellow Card may be withdrawn at any time by UL in its sole discretion. The identification of products and companies on this Yellow Card does not in any way imply endorsement of those products or companies by UL. UL does not assume and expressly disclaims, liability to any person for any loss or damage (including lost profits, lost savings, or any indirect, special, incidental, consequential or punitive damages whether or not UL has been advised of the possibility of such damages) arising out of, or in connection with, the use of this Yellow Card regardless of the cause or causes of such loss or damage.

UL Product iQTM

ECBT2.E364711 - Connectors for Use in Data, Signal, Control and Power Applications - Component

Connectors for Use in Data, Signal, Control and Power Applications - Component

See General Information for Connectors for Use in Data, Signal, Control and Power Applications - Component

ZHEJIANG LIANHE ELECTRONIC CO LTD

E364711

Chuangxin Road, YueQing Bay Port Zone

Yueqing, Zhejiang 325600 CHINA

Connector, Model(s) 1.58-LHE f/b 2 , f/b 1 thru 12, f/b A2 or AW., 1.58-LHE f/b 2 thru 6, f/b A2 or AW

Connector, Model(s) 1.58-LHE followed by 2, followed by 1 thru 12, followed by A(T).

Connector, Model(s) 1.58-LHE, f/b 2 thru 6 , f/b A(T),. 1.58-LHE, f/b 2 thru 6, f/b Y(T), 1.58-LHE, f/b 2, f/b 1 thru 12 , f/b Y(T),. 2510-LHE f/b 2 , f/b 1 thru 12, f/b A2 or AW, 2510-LHE f/b 2 thru 6, f/b A2 or AW

Connector, Model(s) 2510-LHE followed by 2, followed by 1 thru 12, followed by A(T)

Connector, Model(s) 2510-LHE, f/b 2 thru 6 , f/b A(T), 2510-LHE, f/b 2 thru 6, f/b Y(T), 2510-LHE, f/b 2, f/b 1 thru 12 , f/b Y(T), 5.08-LHE f/b 2 , f/b 1 thru 12, f/b A2 or AW, 5.08-LHE f/b 2 thru 6, f/b A2 or AW

Connector, Model(s) 5.08-LHE followed by 2, followed by 1 thru 12, followed by A(T)

Connector, Model(s) 5.08-LHE, f/b 2 thru 6 , f/b A(T), 5.08-LHE, f/b 2 thru 6, f/b Y(T), 5.08-LHE, f/b 2, f/b 1 thru 12 , f/b Y(T), 51005-LHE f/b 2 , f/b 1 thru 12, f/b A2 or AW, 51005-LHE f/b 2 thru 6, f/b A2 or AW

Connector, Model(s) 51005-LHE followed by 2, followed by 1 thru 12, followed by A(T)

Connector, Model(s) 51005-LHE, f/b 2 thru 6 , f/b A(T), 51005-LHE, f/b 2 thru 6, f/b Y(T), 51005-LHE, f/b 2, f/b 1 thru 12 , f/b Y(T) (T), 51006-LHE f/b 2 , f/b 1 thru 12, f/b A2 or AW, 51006-LHE f/b 2 thru 6, f/b A2 or AW

Connector, Model(s) 51006-LHE followed by 2, followed by 1 thru 12, followed by A(T)

Connector, Model(s) 51006-LHE, f/b 2 thru 6 , f/b A(T), 51006-LHE, f/b 2 thru 6, f/b Y(T), 51006-LHE, f/b 2, f/b 1 thru 12 , f/b Y(T) (T), 5102-LHE f/b 2 , f/b 1 thru 12, f/b A2 or AW, 5102-LHE f/b 2 thru 6, f/b A2 or AW

Connector, Model(s) 5102-LHE followed by 2, followed by 1 thru 12, followed by A(T)

Connector, Model(s) 5102-LHE, f/b 2 thru 6 , f/b A(T), 5102-LHE, f/b 2 thru 6, f/b Y(T), 5102-LHE, f/b 2, f/b 1 thru 12 , f/b Y(T), 5240-LHE f/b 2 , f/b 1 thru 12, f/b A2 or AW, 5240-LHE f/b 2 thru 6, f/b A2 or AW

Connector, Model(s) 5240-LHE followed by 2, followed by 1 thru 12, followed by A(T)

Connector, Model(s) 5240-LHE, f/b 2 thru 6 , f/b A(T), 5240-LHE, f/b 2 thru 6, f/b Y(T), 5240-LHE, f/b 2, f/b 1 thru 12 , f/b Y(T), 5500-LHE f/b 2 , f/b 1 thru 12, f/b A2 or AW, 5500-LHE f/b 2 thru 6, f/b A2 or AW

Connector, Model(s) 5500-LHE followed by 2, followed by 1 thru 12, followed by A(T)

Connector, Model(s) 5500-LHE, f/b 2 thru 6 , f/b A(T), 5500-LHE, f/b 2 thru 6, f/b Y(T), 5500-LHE, f/b 2, f/b 1 thru 12 , f/b Y(T), 5557 followed by 2 thru 6, followed by A(T), 5557 followed by 2 thru 6, followed by A2 or AW, 5557 followed by 2 thru 6, followed by Y(T)

Connector, Model(s) 5557 followed by 2, followed by 1 thru 12, followed by A(T).

- Connector**, Model(s) 5557 followed by 2, followed by 1 thru 12, followed by A2 or AW
- Connector**, Model(s) 5557 followed by 2, followed by 1 thru 12, followed by Y(T)
- Connector**, Model(s) 5559-LHE f/b 2 , f/b 1 thru 12, f/b A2 or AW, 5559-LHE f/b 2 thru 6, f/b A2 or AW
- Connector**, Model(s) 5559-LHE followed by 2, followed by 1 thru 12, followed by A(T).
- Connector**, Model(s) 5559-LHE, f/b 2 thru 6 , f/b A(T), 5559-LHE, f/b 2 thru 6, f/b Y(T), 5559-LHE, f/b 2, f/b 1 thru 12 , f/b Y(T), 5566-LHE f/b 2 , f/b 1 thru 12, f/b A2 or AW, 5566-LHE f/b 2 thru 6, f/b A2 or AW
- Connector**, Model(s) 5566-LHE followed by 2, followed by 1 thru 12, followed by A(T)
- Connector**, Model(s) 5566-LHE, f/b 2 thru 6 , f/b A(T), 5566-LHE, f/b 2 thru 6, f/b Y(T), 5566-LHE, f/b 2, f/b 1 thru 12 , f/b Y(T), 5569-LHE f/b 2 , f/b 1 thru 12, f/b A2 or AW, 5569-LHE f/b 2 thru 6, f/b A2 or AW
- Connector**, Model(s) 5569-LHE followed by 2, followed by 1 thru 12, followed by A(T)
- Connector**, Model(s) 5569-LHE, f/b 2 thru 6 , f/b A(T), 5569-LHE, f/b 2 thru 6, f/b Y(T), 5569-LHE, f/b 2, f/b 1 thru 12 , f/b Y(T), 5600-LHE f/b 2 , f/b 1 thru 12, f/b A2 or AW, 5600-LHE f/b 2 thru 6, f/b A2 or AW
- Connector**, Model(s) 5600-LHE followed by 2, followed by 1 thru 12, followed by A(T)
- Connector**, Model(s) 5600-LHE, f/b 2 thru 6 , f/b A(T), 5600-LHE, f/b 2 thru 6, f/b Y(T), 5600-LHE, f/b 2, f/b 1 thru 12 , f/b Y(T), 63080-LHE f/b 2 , f/b 1 thru 12, f/b A2 or AW, 63080-LHE f/b 2 thru 6, f/b A2 or AW
- Connector**, Model(s) 63080-LHE followed by 2, followed by 1 thru 12, followed by A(T)
- Connector**, Model(s) 63080-LHE, f/b 2 thru 6 , f/b A(T), 63080-LHE, f/b 2 thru 6, f/b Y(T), 63080-LHE, f/b 2, f/b 1 thru 12 , f/b Y(T), B2502 followed by 2 thru 16, followed by Y(T), BH3.5-2A(T), BH3.5-2Y(T), MX3.0 followed by 2 thru 12, followed by A(T), MX3.0 followed by 2 thru 12, followed by A2 or AW, MX3.0 followed by 2 thru 12, followed by Y(T)
- Connector**, Model(s) MX3.0 followed by 2, followed by 1 thru 12, followed by A(T).
- Connector**, Model(s) MX3.0 followed by 2, followed by 1 thru 12, followed by A2 or AW
- Connector**, Model(s) MX3.0 followed by 2, followed by 1 thru 12, followed by Y(T)
- Connector**, Model(s) PA-LHE f/b 2, f/b 1 thru 12, f/b Y(T), PA-LHE followed by 2 thru 12, followed by A(T)
- Connector**, Model(s) PA-LHE followed by 2 thru 12, followed by A2 or AW
- Connector**, Model(s) PA-LHE followed by 2 thru 12, followed by Y(T)
- Connector**, Model(s) PA-LHE followed by 2, followed by 1 thru 12, followed by A(T)
- Connector**, Model(s) PA-LHE followed by 2, followed by 1 thru 12, followed by A2 or AW
- Connector**, Model(s) PH, PHB, XHB, JC25, SCN followed by -2 thru -20, followed by Y(T), A, AW or AWD
- Connector**, Model(s) PHB followed by 2 thru 16, followed by Y(T). followed by 2 thru 16, followed by AWD, A, AW
- Connector**, Model(s) Series 1.25, 1254, 1255 followed by -2 thru -25, followed by Y(T), A or AW
- Connector**, Model(s) Series 5264 followed by -2 thru -16, followed by Y(T), A or AWD
- Connector**, Model(s) SM followed by -2 thru -18, followed by Y(T) or A(T)
- Connector**, Model(s) VH, 3.96 followed by -2 thru -16, followed by Y(T), A, AW or AWG
- Connector**, Model(s) XA-LHE f/b 2, f/b 1 thru 12, f/b Y(T), XA-LHE followed by 2 thru 12, followed by A(T)
- Connector**, Model(s) XA-LHE followed by 2 thru 12, followed by A2 or AW
- Connector**, Model(s) XA-LHE followed by 2 thru 12, followed by Y(T)
- Connector**, Model(s) XA-LHE followed by 2, followed by 1 thru 12, followed by A(T)
- Connector**, Model(s) XA-LHE followed by 2, followed by 1 thru 12, followed by A2 or AW
- Connector**, Model(s) XH followed by -2 thru -20, followed by Y(T), A, AW, AWGD, AWD or AWGDJ
- Connector**, Model(s) ZH followed by 2 thru 16, followed by AWD or A, ZH followed by 2 thru 16, followed by Y(T).

Model(s) 1.25, followed by -2 thru -16, followed by AB or AWB

Model(s) 51146 or FI-S, followed by -2 thru -16, followed by AB or AWB

Model(s) A5001, followed by -2 thru -7, followed by Y, Y(T), AD or AWD

Model(s) B2501-LHE, A2004-LHE, A4203-LHE, PHR-LHE, PHD-LHE, CH2.5-LHE, DF11-LHE, PHSD-LHE, A5001-LHE, 35155-LHE, 35156-LHE, 5195-LHE, 5196-LHE, followed by 2 thru 16, followed by Y(T)

Model(s) BHS-LHE, SMH250-LHE, SMH200-LHE, L6.2-LHE, 1806-LHE, 2060-LHE, 2541-LHE, JC15-LHE, XHD-LHE, followed by -2, followed by A(T), or Y(T)

Model(s) JWPFL-LHE, B2541-LHE, NV-LHE, DV-LHE, SGN-LHE, SJN-LHE, SDN-LHE, SIN-LHE, 35150-LHE, 35151-LHE, 35180-LHE, 35182-LHE, 35524-LHE, 35965-LHE, RCY-LHE, LC-LHE, VR-LHE, SHJ-LHE, SHL-LHE, DF19-LHE, ACH-LHE, DF13-LHE, IL-Z-LHE, 51146-LHE, SATA-LHE, XSR-LHE, SUR-LHE, SUH-LHE, ZE-LHE, ZND-LHE, ZPD-LHE, A1502-LHE, SFH-LHE, 51004-LHE, PUD-LHE, A20010-LHE, 35507-LHE, DF3-LHE, PND-LHE, RE-LHE, RA-LHE, RF-LHE or A3963, followed by -2 thru -15, followed by Y(T), YB(T) or YC(T), A, A-K, AW, AW-K, AD, AD-K, AWGD, AWGD-K, AQ, AQ-K, AWQ, AWQ-K, AD(BH) or AD(BH)-K.

Model(s) PH, followed by -2 thru -16, followed by AB or AWB

Model(s) PHB, SZN-LHE, SAN-LHE, JC20-LHE, EH-LHE, EI-LHE, EL-LHE, S-EL-LHE, followed by 2 thru 16, followed by AWD, A, AW

Model(s) PHB, SZN-LHE, SAN-LHE, JC20-LHE, EH-LHE, EI-LHE, EL-LHE, S-EL-LHE, followed by 2 thru 16, followed by Y(T)

Model(s) PHB, XH, XHB or XHBD, followed by -2 thru -16, followed by AB or AWB.

Model(s) RAST 5-LHE TAB HEADER ASSY , TH, Vertical, Cat. Nos. 1969738-LHE, 1969740-LHE, 1971845-LHE, 1971846-LHE, 1971895-LHE, 1971896-LHE, 1971946-LHE thru 1971949-LHE, 1971954-LHE thru 1971957-LHE, 2232008-LHE thru 2232011-LHE, 2232000-LHE thru 2232003-LHE, 2232016-LHE thru 2232019-LHE, 1971962-LHE thru 1971965-LHE, 2232024-LHE thru 2232027-LHE, 2232289-LHE thru 2232292-LHE, 2232043-LHE thru 2232074-LHE, 2232298-LHE thru 2232301-LHE, 2232511-LHE, 2232532-LHE, 2232557-LHE, 2232559-LHE, 2232560-LHE, 2232562-LHE, 2232563-LHE, 2232565-LHE, 2232566-LHE, 2232568-LHE, 2232569-LHE, 2232571-LHE, 2232572-LHE, 2232574-LHE, 2232575-LHE, 2232577-LHE, 2232578-LHE, 2232580-LHE, 2232581-LHE, 2232583-LHE, 2232584-LHE, 2232586-LHE, 2232587-LHE, 2232589-LHE, 2232590-LHE, 2232592-LHE, 2232593-LHE, 2232595-LHE, 2232596-LHE, 2232598-LHE, 2232599-LHE, 2232601-LHE, 2232602-LHE, 2232604-LHE, 2232605-LHE, 2232607-LHE, 2232608-LHE, 2232611-LHE thru 2232682-LHE, 2292457-LHE, 2292458-LHE, may incorporate prefix and/or suffix number.), followed by -2 thru -7, followed by Y, Y(T), AD or AWD.

Model(s) SY, followed by -2, followed by Y, Y(T), A or A(T)

Model(s) SYP, SYR, BH4.0-LHE, A10001-LHE, A7501-LHE, A8001-LHE, C2541-LHE, C2542-LHE, D250R-LHE, D280K-LHE, D300R-LHE, D350R-LHE, D400B-LHE, D430R-LHE, D470G-LHE, D480J-LHE, D480K-LHE, D480N-LHE, D480Q-LHE, D520H-LHE, D520K-LHE, D520Q-LHE, D620G-LHE, D630J-LHE, D630N-LHE, D630Q-LHE, D700G-LHE, F001-LHE, F002-LHE, HIF3-LHE, MC100-LHE, MC100-LHE, ME020-LHE, ME010-LHE, F2541-LHE, D2301-LHE, 1719057-LHE, 1719059-1-LHE, P0011-LHE, P0012-LHE, P0013-LHE, C6001-LHE, D2201-LHE, D2202-LHE or P0001-LHE, followed by -2, followed by Y, Y(T), A or A(T).

Model(s) VL-LHE , YL-LHE, SL-LHE, FL-LHE, YHD200-LHE, HA-LHE, LGC-LHE, JR-LHE, SP-LHE, 5025-LHE, followed by 2, followed by 1 thru 12, followed by A(T), Y(T), A2 or AW

Model(s) VL-LHE, YL-LHE, SL-LHE, FL-LHE, YHD200-LHE, HA-LHE, LGC-LHE, JR-LHE, SP-LHE, 5025-LHE, followed by 2 thru 12, followed by A(T), Y(T), A2 or AW

Model(s) XHD, XHE or XHQ, followed by -2 thru -15, followed by Y(T), YB(T) or YC(T), A, A-K, AW, AW-K, AD, AD-K, AWGD, AWGD-K, AQ, AQ-K, AWQ, AWQ-K, AD(BH) or AD(BH)-K.

Model(s) ZH, followed by -2 thru -16, followed by AB or AWB

Model(s) ZHR-LHE, SH-LHE, GH-LHE, NH-LHE, C1251-LHE, DF14-LHE, 5501-LHE, 75416-LHE, 543-LHE, followed by 2 thru 16, followed by AWD or A

Model(s) ZHR-LHE, SH-LHE, GH-LHE, NH-LHE, C1251-LHE, DF14-LHE, 5501-LHE, 75416-LHE, 543-LHE, followed by 2 thru 16, followed by Y(T)

Marking: Company name or trademark  , model designation and the Recognized Component Mark,



on the device or carton.

Last Updated on 2020-02-20

并不是所有出现在本数据库中的公司名称和产品都满足了UL 跟踪检验服务的要求。只有带有 UL 标志的产品，才应该被视为经过 UL 认证，并满足UL 跟踪检验服务的要求。注意查看产品上的标志。

UL 允许在线认证目录中所含材料的复制遵循以下条件：1.指南信息、装配、构造、设计、系统和/或认证（文件）必须在不篡改任何数据（或图纸）的情况下完整且无误性地呈现。2.“经 UL 允许从在线认证目录转载”声明必须出现在所摘取材料的邻近位置。此外，转载材料必须包含以下格式的版权声明：“© 2020 UL LLC”



产品认证证书

证书编号: CQC17134174484

发证日期: 2021年01月20日

有效期至: 2025年08月31日

委托人名称 浙江联和电子有限公司
及注册地址 浙江省乐清市乐清湾港区乐商创业园

制造商名称 浙江联和电子有限公司
及注册地址 浙江省乐清市乐清湾港区乐商创业园

生产企业名称 浙江联和电子有限公司
及生产地址 浙江省乐清市乐清湾港区创新路8号

产品名称和系列、规格、型号 连接器聚酰胺 66(PA66)
型号见附件, 材料名称: 聚酰胺 (PA66), 材料牌号: A3RV0, 全色, 球压:200°C, 灼热丝可燃性指数(GWFI):960/0.3, 灼热丝起燃温度(GWIT):960/0.3, 燃烧等级:V-0@0.3mm,CTI600, 红外光谱,差示扫描量热和热重分析见报告 00601-2020134003037

产品标准和技术要求 GB/T 5169.21-2017, GB/T 5169.12-2013, GB/T 5169.13-2013, GB/T 5169.16-2017, GB/T 4207-2012, GB/T 6040-2019, GB/T 19466.1-2004, GB/T 19466.2-2004, GB/T 19466.3-2004, ISO 11358-1:2014

认证模式 产品检测+获证后监督

上述产品符合 CQC13-036047-2009 认证规则的要求, 特发此证。
证书有效期内本证书的有效性依据发证机构的定期监督获得保持。

可通过扫描下方二维码或登录国家认监委网站 (www.cnca.gov.cn) 查验证书信息



签发: 陆杨

中国质量认证中心



<http://www.cqc.com.cn>

中国·北京·南四环西路188号9区 100070

电话: +86 10 83886666

C 0453132

ZERTIFIKAT ■ CERTIFICATE ■ CERTIFICADO ■ CERTIFIKAT ■ CERTIFICATE ■ CERTIFICADO ■ CERTIFIKAT ■ CERTIFICATE ■ CERTIFICADO ■ CERTIFIKAT

Verification No.: CLZJ1411264692



VERIFICATION OF LVD COMPLIANCE

Applicant: Zhejiang Lianhe Electrical Co., Ltd.
 Houyu village, Shifan town, Yueqing city, Zhejiang province, China.

Manufacturer: Same as applicant

Product Description: Connector Terminal

Model No: A1001, A1002, A1003, A1251, A1252, A1253, A1254, A1255, A1256, A1257, A1501, A1502, A1503, A2001, A2002, A2003, A2004, A2005, A2006, A2007, A2501, A2502, A2503, A2504, A2505, A2506, A2507, A2541, A2542, A2543, A2544, A2545, A3961, A3962, A3963, A3564, A5081, A5082, B1501, B1502, B2001, B2002, B2501, B2502, C01581, C01582, C1251, C2001, C2002, C2501, C2502, C2505, C2506, C3001, C3002, C3003, C3004, C3005, C3006, C3501, C3502, C3701, C3702, C4001, C4002, C4141, C4142, C4201, C4202, C4203, C4204, C4601, C4602, C4501, C4502, C4503, C4504, C5001, C5002, C5031, C5032, C6201, C6202, C6351, C6352, C6701, C6702, D2801, D2802, D2803, D4801, D4802, D4803, D4804, D6301, D6302, D6303

Sufficient samples of the product have been tested and found to be in conformity with
Test Standard: EN 60320-1:2001/A1:2007
 EN 60529:1991/A1:2000

As shown in the
Test Report Number(s): TLZJ1411264692
Date of issue: November 27, 2014

Conclusion

This Verification of LVD Compliance has been granted to the applicant based on the results of tests, performed by laboratory of Global Testing Services Co., Ltd on sample of the above-mentioned product in accordance with the provisions of the relevant specific standards and the Low Voltage Directive 2014/35/EU. The CE marking as shown below can be affixed, under the responsibility of the manufacturer, after completion of an EC Declaration of Conformity and compliance with all relevant EC Directives. The affixing of the CE marking presumes in addition that conditions the conditions in annexes III and IV of the Directive are fulfilled.

Approved by: Hermann Weiher

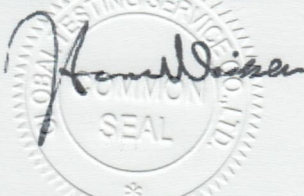

Global Testing Services Co., Ltd
 E-mail: info@gts-lab.com http://www.gts-lab.com
 Room 1501-1502, No. 520 Yishan Rd., Xuhui District, Shanghai, 200235 China



For and on behalf of
 Global Testing Services Co., Ltd



Copyright of this certificate is owned by Global Testing Services Co., Ltd and may not be reproduced other than in full and with the prior approval of the General Manager.



PRODUCT CERTIFICATION

CERTIFICATE NO.: CQC17134174484
Valid from: Jan.20,2021
Valid until: Aug.31,2025

NAME AND REGISTERED ADDRESS OF THE APPLICANT	Zhejiang Lianhe Electronics Co., Ltd. Yueshang Pioneer Park, Yueqingwan Area, Yueqing City, Zhejiang Province
NAME AND REGISTERED ADDRESS OF THE MANUFACTURER	Zhejiang Lianhe Electronics Co., Ltd. Yueshang Pioneer Park, Yueqingwan Area, Yueqing City, Zhejiang Province
NAME AND LOCATION OF THE FACTORY	Zhejiang Lianhe Electronics Co., Ltd. No. 8, Chuangxin Road, Yueqing Bay Port District, Yueqing City, Zhejiang Province
PRODUCT NAME, MODEL AND SPECIFICATION	Connector (PA66) See Annex , Material name: PA66, material grade: A3RV0, All color, Ball pressure:200°C, Glow-Wire Flammability Index(GWFI): 960/0.3, Glow-Wire Ignition Temperature(GWIT):960/0.3, Flammability:V-0@0.3mm, CTI600 , Infrared Analysis,Differential Scanning Calorimetry(DSC), Thermogravimetry (TG) to see report Ref.No: 00601-2020134003037
THE STANDARDS AND TECHNICAL REQUIREMENTS FOR THE PRODUCTS	GB/T 5169.21-2017, GB/T 5169.12-2013, GB/T 5169.13-2013, GB/T 5169.16-2017, GB/T 4207-2012, GB/T 6040-2019, GB/T 19466.1-2004, GB/T 19466.2-2004, GB/T 19466.3-2004, ISO 11358-1:2014
TYPE OF CERTIFICATION SCHEMES	Product Testing + Follow up Factory Inspection

This is to certify that the above mentioned product(s) complies with the requirements of certification rules of CQC13-036047-2009.
The validity of the certificate is subject to positive result of the regular follow up inspection by issuing certification body until the expiry date.

The certificate information is available through the QR code below or CNCA's website: www.cnca.gov.cn





SIGNATURE: 



CHINA QUALITY CERTIFICATION CENTRE

<http://www.cqc.com.cn>
Section 9, No.188, Nansihuan Xilu, Beijing 100070 P.R.China
Tel: +86 10 83886666

C 0453132



CQC has issued an IQNet recognized certificate that the organization:
ZheJiang Lianhe Electronics Co.,Ltd.

Registered Address: Yueqing Bay Port Area, Yueqing City, Wenzhou City, Zhejiang Province, P.R.China
 Operation Address: No.8 Innovation Road, Yueqing Bay Port Area, Yueqing City, Wenzhou City, Zhejiang Province, P.R.China

has implemented and maintains an
Environmental Management System

for the following scope:

Design and Production of Connector and Related Management Activities

which fulfils the requirements of the following standard:

GBT 24001-2016 / ISO 14001:2015

Issued on: February 12, 2020

Expires on: February 11, 2023

Registration Number: **CN00120E30414R0S/3302**

This attestation is directly linked to the IQNet Partner's original certificate and shall not be used as a stand-alone document



Alex Stoichitoiu
 President of IQNet

Lu Mei
 President of CQC



IQNet Partners*:

- AENOR Spain AFNOR Certification France APCER Portugal CCC Cyprus CISQ Italy
- CQC China CQM China CQS Czech Republic Cro Cert Croatia DQS Holding GmbH Germany EAGLE Certification Group USA
- FCAV Brazil FONDONORMA Venezuela ICONTEC Colombia Inspecta Sertifointi Oy Finland INTECO Costa Rica
- IRAM Argentina JQA Japan KFQ Korea MIRTEC Greece MSZT Hungary Nemko AS Norway NSAI Ireland
- NYCE-SIGE México PCBC Poland Quality Austria Austria RR Russia SII Israel SIQ Slovenia
- SIRIM QAS International Malaysia SQS Switzerland SRAC Romania TEST St Petersburg Russia TSE Turkey YUQS Serbia

* The list of IQNet partners is valid at the time of issue of this certificate. Updated information is available under www.iqnet-certification.com



中国认可
国际互认
检测
TESTING
CNAS L0599

检测报告

编号: SHAEC24005901604

日期: 2024年04月18日

第1页, 共11页

客户名称: 浙江联和电子有限公司
客户地址: 浙江省乐清市乐清湾港区乐商创业园
浙江省乐清市乐清湾港区电子信息产业园红旗路8号

样品名称: PA66 连接器
型号: XHD-5A
客户参考信息: 见附件
以上样品及信息由客户提供。

SGS 工作编号: TIC10202403261730301GRQ
样品接收时间: 2024年04月02日
检测周期: 2024年04月02日 ~ 2024年04月15日
检测要求: 根据客户要求检测。
检测方法: 见后续页。
检测结果: 见后续页。

检测要求	结论
欧盟 RoHS 指令 2011/65/EU 附录 II 的修正指令(EU) 2015/863-铅、汞、镉、六价铬、多溴联苯 (PBB)、多溴二苯醚 (PBDE)、邻苯二甲酸二(2-乙基己基)酯 (DEHP)、邻苯二甲酸丁苄酯 (BBP)、邻苯二甲酸二丁酯 (DBP)和邻苯二甲酸二异丁酯 (DIBP)	符合
欧盟 RoHS 指令 2011/65/EU 附录 II 的修正指令(EU) 2015/863-铅、汞、镉和六价铬	符合

通标标准技术服务(上海)有限公司
授权签名

Jenny Lan 兰柳珍
批准签署人

scan to see the report



67D0D105



Unless otherwise agreed in writing, this document is issued by the Company subject to its General Conditions of Service printed overleaf, available on request or accessible at <http://www.sgs.com/en/Terms-and-Conditions.aspx> and, for electronic format documents, subject to Terms and Conditions for Electronic Documents at <http://www.sgs.com/en/Terms-and-Conditions/Terms-g-Documents.aspx>. Attention is drawn to the limitation of liability, indemnification and jurisdiction issues defined therein. Any holder of this document is advised that information contained hereon reflects the Company's findings at the time of its intervention only and within the limits of Client's instructions, if any. The Company's sole responsibility is to its Client and this document does not exonerate parties to a transaction from exercising all their rights and obligations under the transaction documents. This document cannot be reproduced except in full, without prior written approval of the Company. Any unauthorized alteration, forgery or falsification of the content or appearance of this document is unlawful and offenders may be prosecuted to the fullest extent of the law. Unless otherwise stated the results shown in this test report refer only to the sample(s) tested.
Attention: To check the authenticity of testing/inspection report & certificate, please contact us at telephone: (86-755) 8307 1443, or email: CN.Doccheck@sgs.com
3rd Building, No. 889 Yishan Road Xuhui District, Shanghai China 200233 t E&E (86-21) 61402553 f E&E (86-21) 64953679 www.sgs.com.cn
中国·上海·徐汇区宜山路889号3号楼 邮编: 200233 t HL (86-21) 61402594 f HL (86-21) 61156899 e sgs.china@sgs.com

Member of the SGS Group (SGS SA)

SGS

检测报告

编号: SHAEC24005901604

日期: 2024年04月18日

第2页, 共11页

检测结果:

检测部件外观描述:

样品序号	样品编号	SGS 样品 ID	样品描述
SN1	A1	SHA24-0059016-0001.C001	白色塑料部分
SN2	A2	SHA24-0059016-0001.C002	银色金属

备注:

- (1) 1 mg/kg = 1 ppm = 0.0001%
- (2) MDL= 方法检测限
- (3) ND = 未检出(< MDL)
- (4) "-" = 未规定

欧盟 RoHS 指令 2011/65/EU 附录 II 的修正指令(EU) 2015/863-铅、汞、镉、六价铬、多溴联苯 (PBB)、多溴二苯醚 (PBDE)、邻苯二甲酸二(2-乙基己基)酯 (DEHP)、邻苯二甲酸丁基酯 (BBP)、邻苯二甲酸二丁酯 (DBP)和邻苯二甲酸二异丁酯 (DIBP)

检测方法: 参考 IEC 62321-4:2013+AMD1:2017, IEC 62321-5:2013, IEC 62321-7-2:2017, IEC 62321-6:2015 和 IEC 62321-8:2017, 采用 ICP-OES/AAS, UV-Vis 和 GC-MS 进行分析。

检测项目	限值	单位	MDL	A1
铅 (Pb)	1000	mg/kg	2	ND
汞 (Hg)	1000	mg/kg	2	ND
镉 (Cd)	100	mg/kg	2	ND
六价铬 (Cr(VI))	1000	mg/kg	8	ND
多溴联苯之和 (PBB)	1000	mg/kg	-	ND
一溴联苯 (MonoBB)	-	mg/kg	5	ND
二溴联苯 (DiBB)	-	mg/kg	5	ND
三溴联苯 (TriBB)	-	mg/kg	5	ND
四溴联苯 (TetraBB)	-	mg/kg	5	ND
五溴联苯 (PentaBB)	-	mg/kg	5	ND
六溴联苯 (HexaBB)	-	mg/kg	5	ND
七溴联苯 (HeptaBB)	-	mg/kg	5	ND
八溴联苯 (OctaBB)	-	mg/kg	5	ND
九溴联苯 (NonaBB)	-	mg/kg	5	ND
十溴联苯 (DecaBB)	-	mg/kg	5	ND
多溴二苯醚之和 (PBDE)	1000	mg/kg	-	ND
一溴二苯醚 (MonoBDE)	-	mg/kg	5	ND
二溴二苯醚 (DiBDE)	-	mg/kg	5	ND
三溴二苯醚 (TriBDE)	-	mg/kg	5	ND
四溴二苯醚 (TetraBDE)	-	mg/kg	5	ND
五溴二苯醚 (PentaBDE)	-	mg/kg	5	ND
六溴二苯醚 (HexaBDE)	-	mg/kg	5	ND



Unless otherwise agreed in writing, this document is issued by the Company subject to its General Conditions of Service printed overleaf, available on request or accessible at <http://www.sgs.com/en/Terms-and-Conditions.aspx> and, for electronic format documents, subject to Terms and Conditions for Electronic Documents at <http://www.sgs.com/en/Terms-and-Conditions/Terms-e-Documents.aspx>. Attention is drawn to the limitation of liability, indemnification and jurisdiction issues defined therein. Any holder of this document is advised that information contained hereon reflects the Company's findings at the time of its intervention only and within the limits of Client's instructions, if any. The Company's sole responsibility is to its Client and this document does not exonerate parties to a transaction from exercising all their rights and obligations under the transaction documents. This document cannot be reproduced except in full, without prior written approval of the Company. Any unauthorized alteration, forgery or falsification of the content or appearance of this document is unlawful and offenders may be prosecuted to the fullest extent of the law. Unless otherwise stated the results shown in this test report refer only to the sample(s) tested.

Attention: To check the authenticity of testing /inspection report & certificate, please contact us at telephone: (86-755) 8307 1443, or email: CN.Doccheck@sgs.com

3rd Building, No.889 Yishan Road Xuhui District, Shanghai China 200233 t E&E (86-21) 61402553 f E&E (86-21) 64953679 www.sgs.com.cn
中国·上海·徐汇区宜山路889号3号楼 邮编: 200233 t HL (86-21) 61402594 f HL (86-21) 61156899 e sgs.china@sgs.com

Member of the SGS Group (SGS SA)



检测报告

编号: SHAEC24005901604

日期: 2024年04月18日

第3页, 共11页

检测项目	限值	单位	MDL	A1
七溴二苯醚 (HeptaBDE)	-	mg/kg	5	ND
八溴二苯醚 (OctaBDE)	-	mg/kg	5	ND
九溴二苯醚 (NonaBDE)	-	mg/kg	5	ND
十溴二苯醚 (DecaBDE)	-	mg/kg	5	ND
邻苯二甲酸二(2-乙基己基)酯 (DEHP)	1000	mg/kg	50	ND
邻苯二甲酸丁苄酯 (BBP)	1000	mg/kg	50	ND
邻苯二甲酸二丁酯 (DBP)	1000	mg/kg	50	ND
邻苯二甲酸二异丁酯 (DIBP)	1000	mg/kg	50	ND

备注:

- (1) 最大允许限值引用自 RoHS 指令(EU) 2015/863。
 (2) IEC 62321 系列等同于 EN 62321 系列。
 (3) 2021年7月22号开始, DEHP, BBP, DBP 和 DIBP 的限制适用于医疗器械, 包括体外医疗器械, 监控仪表, 包括工业监测和控制仪器。

欧盟 RoHS 指令 2011/65/EU 附录 II 的修正指令(EU) 2015/863-铅、汞、镉和六价铬

检测方法: 参考 IEC 62321-4:2013+AMD1:2017, IEC 62321-5:2013 和 IEC 62321-7-1:2015, 采用 ICP-OES/AAS 和 UV-Vis 进行分析。

检测项目	限值	单位	MDL	A2
铅 (Pb)	1000	mg/kg	2	21
汞 (Hg)	1000	mg/kg	2	ND
镉 (Cd)	100	mg/kg	2	ND
六价铬 (Cr(VI))▼	-	µg/cm ²	0.10	ND

备注:

- (1) 最大允许限值引用自RoHS指令(EU) 2015/863。
 (2) IEC 62321系列等同于 EN 62321系列。
 (3) ▼ = a. 当六价铬的浓度高于0.13 µg/cm²时, 样品为阳性, 即含有六价铬;
 b. 当六价铬的浓度为ND (低于0.10 µg/cm²) 时, 样品为阴性, 即未检测到六价铬;
 c. 当六价铬的浓度介于0.10 µg/cm²与0.13 µg/cm²之间时, 无法直接判定是否检测到六价铬, 因不同个体的样品表面差异可能会影响测定结果。

由于未获知样品的存储条件和生产日期, 样品的六价铬检测结果仅能代表检测时样品含六价铬的状态。

除非另有说明, 参照 ILAC-G8:09/2019, 使用简单接受 (w=0) 的二元判定规则进行符合性判定。
 除非另有说明, 此报告结果仅对检测的样品负责。本报告未经本公司书面许可, 不可部分复制。



Unless otherwise agreed in writing, this document is issued by the Company subject to its General Conditions of Service printed overleaf, available on request or accessible at <http://www.sgs.com/en/Terms-and-Conditions.aspx> and, for electronic format documents, subject to Terms and Conditions for Electronic Documents at <http://www.sgs.com/en/Terms-and-Conditions/Terms-e-Documents.aspx>. Attention is drawn to the limitation of liability, indemnification and jurisdiction issues defined therein. Any holder of this document is advised that information contained hereon reflects the Company's findings at the time of its intervention only and within the limits of Client's instructions, if any. The Company's sole responsibility is to its Client and this document does not exonerate parties to a transaction from exercising all their rights and obligations under the transaction documents. This document cannot be reproduced except in full, without prior written approval of the Company. Any unauthorized alteration, forgery or falsification of the content or appearance of this document is unlawful and offenders may be prosecuted to the fullest extent of the law. Unless otherwise stated the results shown in this test report refer only to the sample(s) tested.
 Attention: To check the authenticity of testing /inspection report & certificate, please contact us at telephone: (86-755) 8307 1443, or email: CN.Doccheck@sgs.com
 3rd Building, No.889 Yishan Road Xuhui District, Shanghai China 200233 t E&E (86-21) 61402553 f E&E (86-21) 64953679 www.sgs.com.cn
 中国·上海·徐汇区宜山路889号3号楼 邮编: 200233 t HL (86-21) 61402594 f HL (86-21) 61156899 e sgs.china@sgs.com

Member of the SGS Group (SGS SA)



检测报告

编号: SHAEC24005901604

日期: 2024年04月18日

第4页, 共11页

附件

元素检测流程图

样品按照下述流程被完全消解

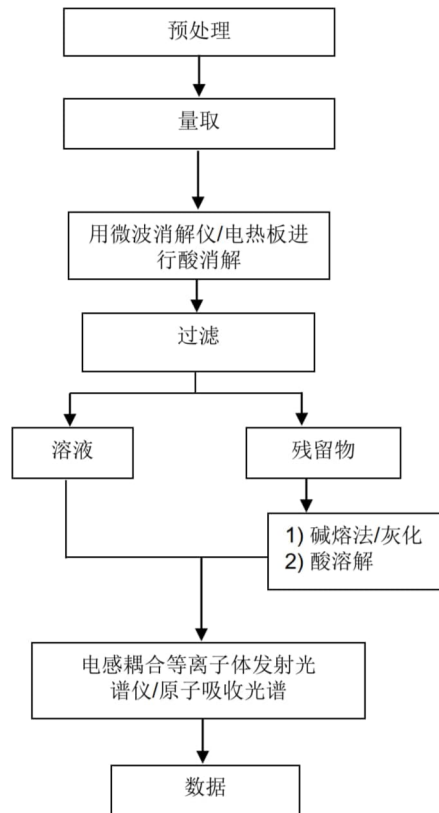

检测



Unless otherwise agreed in writing, this document is issued by the Company subject to its General Conditions of Service printed overleaf, available on request or accessible at <http://www.sgs.com/en/Terms-and-Conditions.aspx> and, for electronic format documents, subject to Terms and Conditions for Electronic Documents at <http://www.sgs.com/en/Terms-and-Conditions/Terms-e-Documents.aspx>. Attention is drawn to the limitation of liability, indemnification and jurisdiction issues defined therein. Any holder of this document is advised that information contained hereon reflects the Company's findings at the time of its intervention only and within the limits of Client's instructions, if any. The Company's sole responsibility is to its Client and this document does not exonerate parties to a transaction from exercising all their rights and obligations under the transaction documents. This document cannot be reproduced except in full, without prior written approval of the Company. Any unauthorized alteration, forgery or falsification of the content or appearance of this document is unlawful and offenders may be prosecuted to the fullest extent of the law. Unless otherwise stated the results shown in this test report refer only to the sample(s) tested.
Attention: To check the authenticity of testing /inspection report & certificate, please contact us at telephone: (86-755) 8307 1443, or email: CN.Doccheck@sgs.com
SGS-CSTC (Shanghai) Technical Services Co., Ltd. 3/F Building, No. 889 Yishan Road Xuhui District, Shanghai China 200233 t E&E (86-21) 61402553 f E&E (86-21) 64953679 www.sgs.com.cn
中国·上海·徐汇区宜山路889号3号楼 邮编: 200233 t HL (86-21) 61402594 f HL (86-21) 61156899 e sgs.china@sgs.com

Member of the SGS Group (SGS SA)



检测报告

编号: SHAEC24005901604

日期: 2024年04月18日

第5页, 共11页

附件

六价铬检测流程图

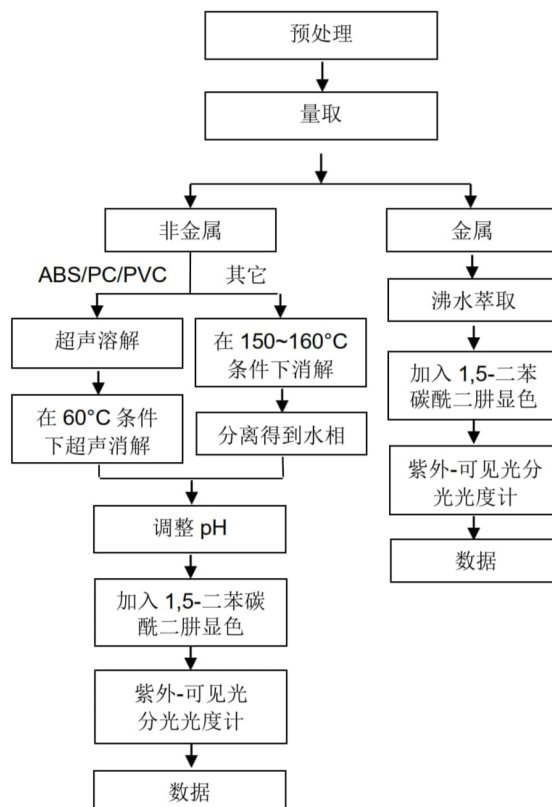

服
金
检
m
&
Tech



Unless otherwise agreed in writing, this document is issued by the Company subject to its General Conditions of Service printed overleaf, available on request or accessible at <http://www.sgs.com/en/Terms-and-Conditions.aspx> and, for electronic format documents, subject to Terms and Conditions for Electronic Documents at <http://www.sgs.com/en/Terms-and-Conditions/Terms-e-Document.aspx>. Attention is drawn to the limitation of liability, indemnification and jurisdiction issues defined therein. Any holder of this document is advised that information contained hereon reflects the Company's findings at the time of its intervention only and within the limits of Client's instructions, if any. The Company's sole responsibility is to its Client and this document does not exonerate parties to a transaction from exercising all their rights and obligations under the transaction documents. This document cannot be reproduced except in full, without prior written approval of the Company. Any unauthorized alteration, forgery or falsification of the content or appearance of this document is unlawful and offenders may be prosecuted to the fullest extent of the law. Unless otherwise stated the results shown in this test report refer only to the sample(s) tested.
Attention: To check the authenticity of testing / inspection report & certificate, please contact us at telephone: (86-755) 8307 1443, or email: CN.Doccheck@sgs.com

SGS-CSTC (Shanghai) Technical Services Co., Ltd. 3F Building, No. 889 Yishan Road, Xuhui District, Shanghai, China 200233 t E&E (86-21) 61402553 f E&E (86-21) 64953679 www.sgs.com
中国·上海·徐汇区宜山路889号3号楼 邮编: 200233 t HL (86-21) 61402594 f HL (86-21) 61156899 e sgs.china@sgs.com

Member of the SGS Group (SGS SA)



检测报告

编号: SHAEC24005901604

日期: 2024年04月18日

第6页, 共11页

附件

PBB/PBDE 检测流程图

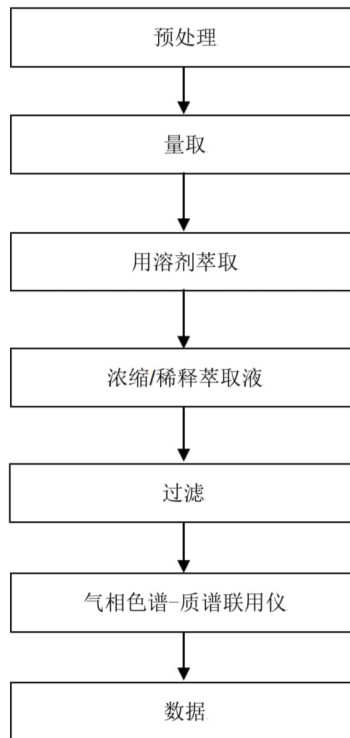

Unless otherwise agreed in writing, this document is issued by the Company subject to its General Conditions of Service printed overleaf, available on request or accessible at <http://www.sgs.com/en/Terms-and-Conditions.aspx> and, for electronic format documents, subject to Terms and Conditions for Electronic Documents at <http://www.sgs.com/en/Terms-and-Conditions/Terms-e-Document.aspx>. Attention is drawn to the limitation of liability, indemnification and jurisdiction issues defined therein. Any holder of this document is advised that information contained hereon reflects the Company's findings at the time of its intervention only and within the limits of Client's instructions, if any. The Company's sole responsibility is to its Client and this document does not exonerate parties to a transaction from exercising all their rights and obligations under the transaction documents. This document cannot be reproduced except in full, without prior written approval of the Company. Any unauthorized alteration, forgery or falsification of the content or appearance of this document is unlawful and offenders may be prosecuted to the fullest extent of the law. Unless otherwise stated the results shown in this test report refer only to the sample(s) tested.
Attention: To check the authenticity of testing /inspection report & certificate, please contact us at telephone: (86-755) 8307 1443, or email: CN.Doccheck@sgs.com

SGS-CSTC (Shanghai) Technical Services (Shanghai) Co., Ltd. 3F Building, No. 889 Yishan Road Xuhui District, Shanghai China 200233 t E&E (86-21) 61402553 f E&E (86-21) 64953679 www.sgs.com
中国·上海·徐汇区宜山路889号3号楼 邮编: 200233 t HL (86-21) 61402594 f HL (86-21) 61156899 e sgs.china@sgs.com

Member of the SGS Group (SGS SA)



检测报告

编号: SHAEC24005901604

日期: 2024年04月18日

第7页, 共11页

附件

Phthalates 检测流程图

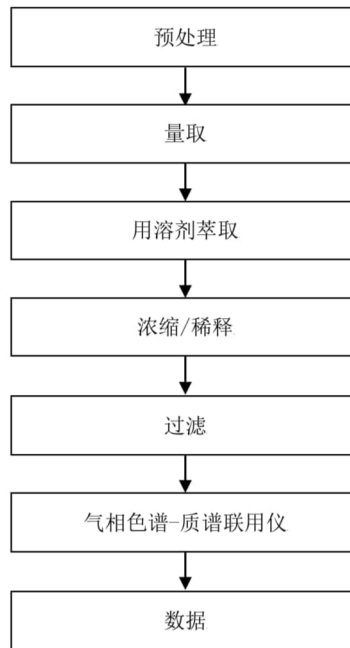

专用
ing
erivc



Unless otherwise agreed in writing, this document is issued by the Company subject to its General Conditions of Service printed overleaf, available on request or accessible at <http://www.sgs.com/en/Terms-and-Conditions.aspx> and, for electronic format documents, subject to Terms and Conditions for Electronic Documents at <http://www.sgs.com/en/Terms-and-Conditions/Terms-e-Document.aspx>. Attention is drawn to the limitation of liability, indemnification and jurisdiction issues defined therein. Any holder of this document is advised that information contained hereon reflects the Company's findings at the time of its intervention only and within the limits of Client's instructions, if any. The Company's sole responsibility is to its Client and this document does not exonerate parties to a transaction from exercising all their rights and obligations under the transaction documents. This document cannot be reproduced except in full, without prior written approval of the Company. Any unauthorized alteration, forgery or falsification of the content or appearance of this document is unlawful and offenders may be prosecuted to the fullest extent of the law. Unless otherwise stated the results shown in this test report refer only to the sample(s) tested.
Attention: To check the authenticity of testing /inspection report & certificate, please contact us at telephone: (86-755) 8307 1443, or email: CN.Doccheck@sgs.com
SGS-CSTC (Shanghai) Technical Services (Shanghai) Co., Ltd. 13th Building, No. 889 Yishan Road Xuhui District, Shanghai China 200233 t E&E (86-21) 61402553 f E&E (86-21) 64953679 www.sgs.com
中国·上海·徐汇区宜山路889号3号楼 邮编: 200233 t HL (86-21) 61402594 f HL (86-21) 61156899 e sgs.china@sgs.com

Member of the SGS Group (SGS SA)



检测报告

编号: SHAEC24005901604

日期: 2024年04月18日

第8页, 共11页

附件:

1.0, SH, SHD, 1.25, 51021, DF14, DF13, GH, ZH, PH, PHB, PA, PHSD, DF11, C1251, 51047, 51146, FI-S, PHD, YHD200, PA, SMP, SMW, SMH, SMH200, SMH200-H, YH200, 20039WR, 杜邦 2.0, XH/TJC3, XA, HA, XHB, XHD, XHE, EH, EI, 小四 P, 5263, 5264, 5267, 5268, SZN, SAN, SCN, SCND, JC15, JC20, JC25, 5102, 5240, SMH250, SMP250, SMW250, 25048HS, 25045HP, SM, TJC8, 杜邦 2.54, TJC8A, 杜邦带锁, TJC8B, TJC8H, 5051, 2510, 美尚美, 43640, 43645, 43020, 43025, 5500, 5600, VH, VHRR, YH396, VHR, 35156, 2139, 3.96, 90331, 5195, 5196, 39612, FL, 5557, 5559, 5566, 5569, SL, RV42, EL, YL, 小 EL, 8981, 大四 P, 5058, 5.08, L6.2, VL, VLP/VLR, TJC2, TJC2A, TJC2B, TJC4, TJC1, 1806, MX3.0, 1.58, 51005, 51006, BH3.5, BH4.0, 63080, 51004, TJC15, A4203, CL014, OTP, MKH, SMF, Cy-X201, 35108, 35150, 35151, 35152, 35180, 35965, 42021, 42022, 42002, 35955, SA, SCS, 35189, 35196, CH10, CH2.5, 543, SLP, SLR, YHL500, YWL500, FFC, FPC, 20030, 250, LGC, S11, YH025, 35155, 25415, 5197, 5198, 110, 2.8, 6.3, SCS

NH, XHQ, 42474, 42475, QH, NV, 50300, 50301, 5025, 3191, 5199, STV5, YHL500, YWL500, F001, F002, D440, D600, D620, D700, D220, D230, D250, D480, D520, D280, D630, D430, D400, D450, U-T, F1001-T, SIN-T, 774, 773, 778, 294, TU-JTK(SV), TU(SNB), TO-JTK(RV), MDD, FDD, TG-JT, IDC, AUTO, CONNECTOR, DJ70, DT04, DT06, UY/K1, UY2/K2, UR/K3, UR2, UB/K4, UB2A, UG/K5, U1R/K8, U1B/K9, HJKT10, UDW2, 314, A5001, A5002, MC100, FPC2.54, SGN, PHR, ZHR, 205, 5.2, C1801, C1802, 2060, A5003, ME020, ME010, FPC/FFC, B2541, 1971845, 1971846, 2232043, 2232044, 2232511, 1971895, 1971896, JWPF, SY, Molex1.5, ME0100, RAST, A5004, DV, SJN, SDN, 35182, 35524, RCY, LC, VR, SHJ, SHL, DF19, ACH, IL-Z, SATA, XSR, SUR, SUH, ZE, ZND, ZPD, SFH, PUD, AMP2.0, 35507, DF3, PND, RE, RA, RF, SYP/SYR, HIF3, MC100/ME020/ME010, F2541, VHB, VHC, VHD SHB1.0, NHB1.0, FIS, VHE, 35313, 30PIN, PR9-409, PR5-70-1, PR5-24, 5240B, 5500B, 5600B, 13006, 13007, 3DLG06FW, 1719057, 1719058, 1719059, CS28H, 9102501, 9103101, 9111001, PP0311401, 33EMMT26FBK, 3CN2BH02, 3FW06FBM, PP0426613, PP0426202, GIC3.3, 1376421-1, XADR, XADRR, 179846, 179849, XHR, 50235, PAD, PNI, SDL2.5, PS-250-2A-15, 4.8, 62306, H9002, DC4235, 62308, 62420-1, B35E0, 63658-1, 1060-16-0122, RH0409000142, RH011810030061, RH040499000142, RH011810030090, 299900421692, 33146412, 1.25 插板, SPS-01T-110, 282104-1, 282105-1, 282110-1, 282109-1, 21T1000501, 20T1001001, PP043531T, XNIRP, XL, 1123343-1, DF16, 1473413-1, 12147302, MG641234-5, PHBS, 0.8, Molex1.2, 35746, 35748, APM2.54

1969738, 1969740, 1971845, 1971846, 1971895, 1971896, 1971946 thru 1971949, 1971954 thru 1971957, 2232008 thru 2232011, 2232000 thru 2232003, 2232016 thru 2232019, 1971962 thru 1971965, 2232024 thru 2232027, 2232289 thru 2232292, 2232043 thru 2232074, 2232298 thru 2232301, 2232511, 2232532, 2232557, 2232559, 2232560, 2232562, 2232563, 2232565, 2232566, 2232568, 2232569, 2232571, 2232572, 2232574, 2232575, 2232577, 2232578, 2232580, 2232581, 2232583, 2232584, 2232586, 2232587, 2232589, 2232590, 2232592, 2232593, 2232595, 2232596, 2232598, 2232599, 2232601, 2232602, 2232604, 2232605, 2232607, 2232608, 2232611 thru 2232682, 2292457, 2292458, 1064, 2064, 3064, 1080, 2080, 3080, 1100, 2100, 3100, 1120, 2120, 3120, 1150, 2150, 3150, 1180, 2180, 3180, 1230, 2230, 3230, 1250, 2250, 3250, 1280, 2280, 3280, 1300, 2300, 3300, 1480, 2480, 3480, 1630, 2630, 3630, 1780, 2780, 3780, 1950, 2950, 3950, 1010, 2010, 3010, 1013, 2013, 3013, 1015, 2015, 3015, 1016, 2016, 3016, 1025, 2025, 3025, 1035, 2035, 3035, 1045, 2045, 3045, 1058, 2058, 3058, 1999, 2999, 3999, 401, 402, 403, 503, TPA, BX, CPA, 404, 501, 502 A1001 A1002 A1003 A1004 A1005 A1006 A1007 A1008 A1009



Unless otherwise agreed in writing, this document is issued by the Company subject to its General Conditions of Service printed overleaf, available on request or accessible at <http://www.sgs.com/en/Terms-and-Conditions.aspx> and, for electronic format documents, subject to Terms and Conditions for Electronic Documents at <http://www.sgs.com/en/Terms-and-Conditions/Terms-e-Documents.aspx>. Attention is drawn to the limitation of liability, indemnification and jurisdiction issues defined therein. Any holder of this document is advised that information contained hereon reflects the Company's findings at the time of its intervention only and within the limits of Client's instructions, if any. The Company's sole responsibility is to its Client and this document does not exonerate parties to a transaction from exercising all their rights and obligations under the transaction documents. This document cannot be reproduced except in full, without prior written approval of the Company. Any unauthorized alteration, forgery or falsification of the content or appearance of this document is unlawful and offenders may be prosecuted to the fullest extent of the law. Unless otherwise stated the results shown in this test report refer only to the sample(s) tested. Attention: To check the authenticity of testing/inspection report & certificate, please contact us at telephone: (86-755) 8307 1443, or email: CN.Doccheck@sgs.com
SGS-CSTC (China) Technical Services (Shanghai) Co., Ltd. 200233 tE&E (86-21) 61402553 fE&E (86-21) 64953679 www.sgsgroup.com.cn
13' Building, No. 889 Yishan Road Xuhui District, Shanghai China 200233 tHL (86-21) 61402594 fHL (86-21) 61156899 e sgs.china@sgs.com
中国·上海·徐汇区宜山路889号3号楼 邮编: 200233

Member of the SGS Group (SGS SA)



检测报告

编号: SHAEC24005901604

日期: 2024年04月18日

第9页, 共11页

A1251 A1252 A1253 A1254 A1255 A1256 A1257 A1258 A1259
A1501 A1502 A1503 A1504 A1505 A1506 A1507 A1508 A1509
A2001 A2002 A2003 A2004 A2005 A2006 A2007 A2008 A2009
A2010 A2011 A2012 A2013 A2014 A2015 A2016 A2017 A2018
A2501 A2502 A2503 A2504 A2505 A2506 A2507 A2508 A2509
A25010 A25011 A25012 A25013 A25014 A25015 A25016 A25017 A25018
A2541 A2542 A2543 A2544 A2545 A2546 A2547 A2548 A2549
A3001 A3002 A3003 A3004 A3005 A3006 A3007 A3008 A3009
A3301 A3302 A3303 A3304 A3305 A3306 A3307 A3308 A3309
A3961 A3962 A3963 A3964 A3965 A3966 A3967 A3968 A3969
A4201 A4202 A4203 A4204 A4205 A4206 A4207 A4208 A4209
A5001 A5002 A5003 A5004 A5005 A5006 A5007 A5008 A5009
A5081 A5082 A5083 A5084 A5085 A5086 A5087 A5088 A5089
A6501 A6502 A6503 A6504 A6505 A6506 A6507 A6508 A6509
B1251 B1252 B1253 B1254 B1255 B1256 B1257 B1258 B1259
B1501 B1502 B1503 B1504 B1505 B1506 B1507 B1508 B1509
B2001 B2002 B2003 B2004 B2005 B2006 B2007 B2008 B2009
B2501 B2502 B2503 B2504 B2505 B2506 B2507 B2508 B2509
B2541 B2542 B2543 B2544 B2545 B2546 B2547 B2548 B2549
B76201 B76202 B76203 B76204 B76205 B76206 B76207 B76208 B76209
B13001 B13002 B13003 B13004 B13005 B13006 B13007 B13008 B13009
C01581 C01582 C01583 C01584 C01585 C01586 C01587 C01588 C01589
C1251 C1252 C1253 C1254 C1255 C1256 C1257 C1258 C1259
C1501 C1502 C1503 C1504 C1505 C1506 C1507 C1508 C1509
C2001 C2002 C2003 C2004 C2005 C2006 C2007 C2008 C2009
C2501 C2502 C2503 C2504 C2505 C2506 C2507 C2508 C2509
C25010 C25011 C25012 C25013 C25014 C25015 C25016 C25017 C25018
C2541 C2542 C2543 C2544 C2545 C2546 C2547 C2548 C2549
C3001 C3002 C3003 C3004 C3005 C3006 C3007 C3008 C3009
C3501 C3502 C3503 C3504 C3505 C3506 C3507 C3508 C3509
C3681 C3682 C3683 C3684 C3685 C3686 C3687 C3688 C3689
C3961 C3962 C3963 C3964 C3965 C3966 C3967 C3968 C3969
C4001 C4002 C4003 C4004 C4005 C4006 C4007 C4008 C4009
C4141 C4142 C4143 C4144 C4145 C4146 C4147 C4148 C4149
C4201 C4202 C4203 C4204 C4205 C4206 C4207 C4208 C4209
C4501 C4502 C4503 C4504 C4505 C4506 C4507 C4508 C4509
C5001 C5002 C5003 C5004 C5005 C5006 C5007 C5008 C5009
C6201 C6202 C6203 C6204 C6205 C6206 C6207 C6208 C6209
C6351 C6352 C6353 C6354 C6355 C6356 C6357 C6358 C6359
D2801 D2802 D2803 D2804 D2805 D2806 D2807 D2808 D2809
D4801 D4802 D4803 D4804 D4805 D4806 D4807 D4808 D4809
D5201 D5202 D5203 D5204 D5205 D5206 D5207 D5208 D5209
D6301 D6302 D6303 D6304 D6305 D6306 D6307 D6308 D6309
D6201 D6202 D6203 D6204 D6205 D6206 D6207 D6208 D6209
D7001 D7002 D7003 D7004 D7005 D7006 D7007 D7008 D7009
F0501 F0502 F0503 F0504 F0505 F0506 F0507 F0508 F0509
F05010 F05011 F05012 F05013 F05014 F05015 F05016 F05017 F05018
F1001 F1002 F1003 F1004 F1005 F1006 F1007 F1008 F1009
F10010 F10011 F10012 F10013 F10014 F10015 F10016 F10017 F10018
F2541 F2542 F2543 F2544 F2545 F2546 F2547 F2548 F2549
P0001 P0002 P0003 P0004 P0005 P0006 P0007 P0008 P0009
P0010 P0011 P0012 P0013 P0014 P0015 P0016 P0017 P0018

检测合格



Unless otherwise agreed in writing, this document is issued by the Company subject to its General Conditions of Service printed overleaf, available on request or accessible at <http://www.sgs.com/en/Terms-and-Conditions.aspx> and, for electronic format documents, subject to Terms and Conditions for Electronic Documents at <http://www.sgs.com/en/Terms-and-Conditions/Terms-e-Documents.aspx>. Attention is drawn to the limitation of liability, indemnification and jurisdiction issues defined therein. Any holder of this document is advised that information contained hereon reflects the Company's findings at the time of its intervention only and within the limits of Client's instructions, if any. The Company's sole responsibility is to its Client and this document does not exonerate parties to a transaction from exercising all their rights and obligations under the transaction documents. This document cannot be reproduced except in full, without prior written approval of the Company. Any unauthorized alteration, forgery or falsification of the content or appearance of this document is unlawful and offenders may be prosecuted to the fullest extent of the law. Unless otherwise stated the results shown in this test report refer only to the sample(s) tested.
Attention: To check the authenticity of testing/inspection report & certificate, please contact us at telephone: (86-755) 8307 1443, or email: CN.Doccheck@sgs.com
SGS-CSTC (China) Technical Services (Shanghai) Co., Ltd. 200233 t E&E (86-21) 61402553 f E&E (86-21) 64953679 www.sgsgroup.com.cn
3rd Building, No. 889 Yishan Road Xuhui District, Shanghai China 200233 t HL (86-21) 61402594 f HL (86-21) 61156899 e sgs.china@sgs.com
中国·上海·徐汇区宜山路889号3号楼 邮编: 200233

Member of the SGS Group (SGS SA)



检测报告

编号: SHAEC24005901604

日期: 2024年04月18日

第 10 页, 共 11 页

P0019 P0020 P0021 P0022 P0023 P0024 P0025 P0026 P0027
D2301 D2302 D2303 D2304 D2305 D2306 D2307 D2308 D2309
D6001 D6002 D6003 D6004 D6005 D6006 D6007 D6008 D6009
D2201 D2202 D2203 D2204 D2205 D2206 D2207 D2208 D2209
B10901 B13601 C6001 C6002 C6003 C6004 A20010 A20011 P0028
P0029 P0030 P0031 B11001 C2201 C2202 C4101 C6701 C6702
D630J D700G A20012 P0032 B4001 A0801 A1271 A1803
A10001 A4141 A7501 A7502 A3501 A1201 A4001 A6351 B14501
A20013 A1202 D2501 A1801 A1802

上海公司 明物



Unless otherwise agreed in writing, this document is issued by the Company subject to its General Conditions of Service printed overleaf, available on request or accessible at <http://www.sgs.com/en/Terms-and-Conditions.aspx> and, for electronic format documents, subject to Terms and Conditions for Electronic Documents at <http://www.sgs.com/en/Terms-and-Conditions/Terms-e-Document.aspx>. Attention is drawn to the limitation of liability, indemnification and jurisdiction issues defined therein. Any holder of this document is advised that information contained hereon reflects the Company's findings at the time of its intervention only and within the limits of Client's instructions, if any. The Company's sole responsibility is to its Client and this document does not exonerate parties to a transaction from exercising all their rights and obligations under the transaction documents. This document cannot be reproduced except in full, without prior written approval of the Company. Any unauthorized alteration, forgery or falsification of the content or appearance of this document is unlawful and offenders may be prosecuted to the fullest extent of the law. Unless otherwise stated the results shown in this test report refer only to the sample(s) tested.
Attention: To check the authenticity of testing / inspection report & certificate, please contact us at telephone: (86-755) 8307 1443, or email: CN.Doccheck@sgs.com
SGS-CSTC (Shanghai) Technical Services (Shanghai) Co., Ltd. 200233 t E&E (86-21) 61402553 f E&E (86-21) 64953679 www.sgs.com
Testing Center, China 中国·上海·徐汇区宜山路889号3号楼 邮编: 200233 t HL (86-21) 61402594 f HL (86-21) 61156899 e sgs.china@sgs.com

Member of the SGS Group (SGS SA)



检测报告

编号: SHAEC24005901604

日期: 2024年04月18日

第 11 页, 共 11 页

样品照片:

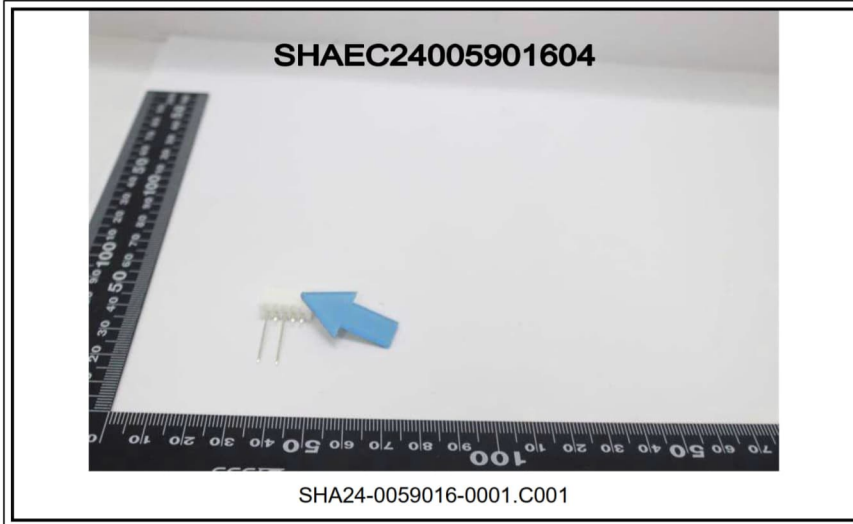

此照片仅限于随 SGS 正本报告使用
报告结束



Unless otherwise agreed in writing, this document is issued by the Company subject to its General Conditions of Service printed overleaf, available on request or accessible at <http://www.sgs.com/en/Terms-and-Conditions.aspx> and, for electronic format documents, subject to Terms and Conditions for Electronic Documents at <http://www.sgs.com/en/Terms-and-Conditions/Terms-e-Documents.aspx>. Attention is drawn to the limitation of liability, indemnification and jurisdiction issues defined therein. Any holder of this document is advised that information contained hereon reflects the Company's findings at the time of its intervention only and within the limits of Client's instructions, if any. The Company's sole responsibility is to its Client and this document does not exonerate parties to a transaction from exercising all their rights and obligations under the transaction documents. This document cannot be reproduced except in full, without prior written approval of the Company. Any unauthorized alteration, forgery or falsification of the content or appearance of this document is unlawful and offenders may be prosecuted to the fullest extent of the law. Unless otherwise stated the results shown in this test report refer only to the sample(s) tested.
Attention: To check the authenticity of testing / inspection report & certificate, please contact us at telephone: (86-755) 8307 1443, or email: CN.Doccheck@sgs.com

SGS-CSTC (Shanghai) Technical Services Co., Ltd. 200233 t E&E (86-21) 61402553 f E&E (86-21) 64953679 www.sgs.com
SGS Inspection & Testing Services 中国·上海·徐汇区宜山路889号3号楼 邮编: 200233 t HL (86-21) 61402594 f HL (86-21) 61156899 e sgs.china@sgs.com

Member of the SGS Group (SGS SA)



中国认可
国际互认
检测
TESTING
CNAS L0599

检测报告

编号: SHAEC24008425816

日期: 2024年05月07日

第1页, 共8页

客户名称: 浙江联和电子有限公司
客户地址: 浙江省乐清市乐清湾港区乐商创业园
浙江省乐清市乐清湾港区电子信息产业园红旗路8号

样品名称: 端子针
客户参考信息: 见附件
以上样品及信息由客户提供。

SGS 工作编号: TIC1020240424174615KLN9
样品接收时间: 2024年04月26日
检测周期: 2024年04月26日~2024年05月07日
检测要求: 根据客户要求检测。
检测方法: 见后续页。
检测结果: 见后续页。

检测要求	结论
欧盟 RoHS 指令 2011/65/EU 附录 II 的修正指令(EU) 2015/863-铅、汞、镉和六价格	符合

通标准技术服务(上海)有限公司
授权签名

Dora Hu 胡敏
批准签署人



Unless otherwise agreed in writing, this document is issued by the Company subject to its General Conditions of Service printed overleaf, available on request or accessible at <http://www.sgs.com/en/Terms-and-Conditions.aspx> and, for electronic format documents, subject to Terms and Conditions for Electronic Documents at <http://www.sgs.com/en/Terms-and-Conditions/Terms-e-Documents.aspx>. Attention is drawn to the limitation of liability, indemnification and jurisdiction issues defined therein. Any holder of this document is advised that information contained hereon reflects the Company's findings at the time of its intervention only and within the limits of Client's instructions, if any. The Company's sole responsibility is to its Client and this document does not exonerate parties to a transaction from exercising all their rights and obligations under the transaction documents. This document cannot be reproduced except in full, without prior written approval of the Company. Any unauthorized alteration, forgery or falsification of the content or appearance of this document is unlawful and offenders may be prosecuted to the fullest extent of the law. Unless otherwise stated the results shown in this test report refer only to the sample(s) tested.
Attention: To check the authenticity of testing/inspection report & certificate, please contact us at telephone: (86-755) 8307 1443, or email: CN.Doccheck@sgs.com
3rd Building, No. 889 Yishan Road Xuhui District, Shanghai China 200233 t E&E (86-21) 61402553 f E&E (86-21) 64953679 www.sgsgroup.com.cn
中国·上海·徐汇区宜山路889号3号楼 邮编: 200233 t HL (86-21) 61402594 f HL (86-21) 61156899 e sgs.china@sgs.com

Member of the SGS Group (SGS SA)

SGS

检测报告

编号: SHAEC24008425816

日期: 2024年05月07日

第2页, 共8页

检测结果:

检测部件外观描述:

样品序号	样品编号	SGS 样品 ID	样品描述
SN1	A3	SHA24-0084258-0001.C003	银色金属

备注:

- (1) 1 mg/kg = 1 ppm = 0.0001%
- (2) MDL= 方法检测限
- (3) ND = 未检出 (< MDL)
- (4) "-" = 未规定

欧盟 RoHS 指令 2011/65/EU 附录 II 的修正指令(EU) 2015/863-铅、汞、镉和六价铬

检测方法: 参考 IEC 62321-4:2013+AMD1:2017, IEC 62321-5:2013 和 IEC 62321-7-1:2015, 采用 ICP-OES/AAS 和 UV-Vis 进行分析。

检测项目	限值	单位	MDL	A3
铅 (Pb)	1000	mg/kg	2	37
汞 (Hg)	1000	mg/kg	2	ND
镉 (Cd)	100	mg/kg	2	ND
六价铬 (Cr(VI)) [▼]	-	µg/cm ²	0.10	ND

备注:

- (1) 最大允许限值引用自RoHS指令(EU) 2015/863。
- (2) IEC 62321系列等同于 EN 62321系列。
- (3) [▼] =
 - a. 当六价铬的浓度高于0.13 µg/cm²时, 样品为阳性, 即含有六价铬;
 - b. 当六价铬的浓度为ND (低于0.10 µg/cm²) 时, 样品为阴性, 即未检测到六价铬;
 - c. 当六价铬的浓度介于0.10 µg/cm²与0.13 µg/cm²之间时, 无法直接判定是否检测到六价铬, 因不同个体的样品表面差异可能会影响测定结果。

由于未获知样品的存储条件和生产日期, 样品的六价铬检测结果仅能代表检测时样品含六价铬的状态。

除非另有说明, 参照 ILAC-G8:09/2019, 使用简单接受 (w=0) 的二元判定规则进行符合性判定。

除非另有说明, 此报告结果仅对检测的样品负责。本报告未经本公司书面许可, 不可部分复制。



Unless otherwise agreed in writing, this document is issued by the Company subject to its General Conditions of Service printed overleaf, available on request or accessible at <http://www.sgs.com/en/Terms-and-Conditions.aspx> and, for electronic format documents, subject to Terms and Conditions for Electronic Documents at <http://www.sgs.com/en/Terms-and-Conditions/Terms-e-Documents.aspx>. Attention is drawn to the limitation of liability, indemnification and jurisdiction issues defined therein. Any holder of this document is advised that information contained hereon reflects the Company's findings at the time of its intervention only and within the limits of Client's instructions, if any. The Company's sole responsibility is to its Client and this document does not exonerate parties to a transaction from exercising all their rights and obligations under the transaction documents. This document cannot be reproduced except in full, without prior written approval of the Company. Any unauthorized alteration, forgery or falsification of the content or appearance of this document is unlawful and offenders may be prosecuted to the fullest extent of the law. Unless otherwise stated the results shown in this test report refer only to the sample(s) tested.

Attention: To check the authenticity of testing/inspection report & certificate, please contact us at telephone: (86-755) 8307 1443, or email: CN.Doccheck@sgs.com

3rd Building, No. 889 Yishan Road Xuhui District, Shanghai China 200233 t E&E (86-21) 61402553 f E&E (86-21) 64953679 www.sgs.com.cn
中国·上海·徐汇区宜山路889号3号楼 邮编: 200233 t HL (86-21) 61402594 f HL (86-21) 61156899 e sgs.china@sgs.com

Member of the SGS Group (SGS SA)



检测报告

编号: SHAEC24008425816

日期: 2024年05月07日

第3页, 共8页

附件

元素检测流程图

样品按照下述流程被完全消解

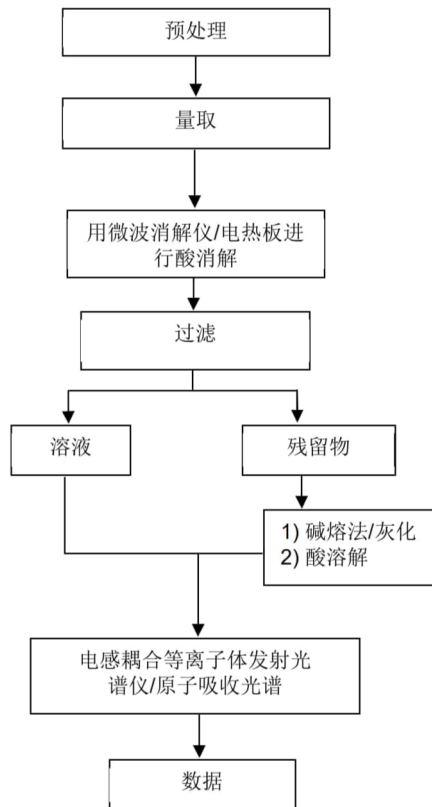

收本
检测
specfic
检测



Unless otherwise agreed in writing, this document is issued by the Company subject to its General Conditions of Service printed overleaf, available on request or accessible at <http://www.sgs.com/en/Terms-and-Conditions.aspx> and, for electronic format documents, subject to Terms and Conditions for Electronic Documents at <http://www.sgs.com/en/Terms-and-Conditions/Terms-e-Document.aspx>. Attention is drawn to the limitation of liability, indemnification and jurisdiction issues defined therein. Any holder of this document is advised that information contained hereon reflects the Company's findings at the time of its intervention only and within the limits of Client's instructions, if any. The Company's sole responsibility is to its Client and this document does not exonerate parties to a transaction from exercising all their rights and obligations under the transaction documents. This document cannot be reproduced except in full, without prior written approval of the Company. Any unauthorized alteration, forgery or falsification of the content or appearance of this document is unlawful and offenders may be prosecuted to the fullest extent of the law. Unless otherwise stated the results shown in this test report refer only to the sample(s) tested.

Attention: To check the authenticity of testing/inspection report & certificate, please contact us at telephone: (86-755) 8307 1443, or email: CN.Doccheck@sgs.com

3rd Building, No. 889 Yishan Road Xuhui District, Shanghai China 200233 t E&E (86-21) 61402553 f E&E (86-21) 64953679 www.sgs.com.cn
中国·上海·徐汇区宜山路889号3号楼 邮编: 200233 t HL (86-21) 61402594 f HL (86-21) 61156899 e sgs.china@sgs.com

Member of the SGS Group (SGS SA)



检测报告

编号: SHAEC24008425816

日期: 2024年05月07日

第4页, 共8页

附件

六价铬检测流程图

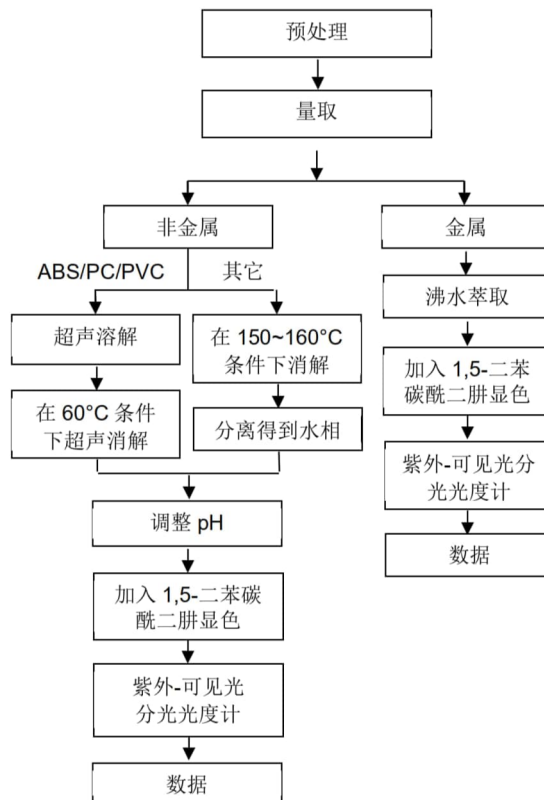

Unless otherwise agreed in writing, this document is issued by the Company subject to its General Conditions of Service printed overleaf, available on request or accessible at <http://www.sgs.com/en/Terms-and-Conditions.aspx> and, for electronic format documents, subject to Terms and Conditions for Electronic Documents at <http://www.sgs.com/en/Terms-and-Conditions/Terms-e-Document.aspx>. Attention is drawn to the limitation of liability, indemnification and jurisdiction issues defined therein. Any holder of this document is advised that information contained hereon reflects the Company's findings at the time of its intervention only and within the limits of Client's instructions, if any. The Company's sole responsibility is to its Client and this document does not exonerate parties to a transaction from exercising all their rights and obligations under the transaction documents. This document cannot be reproduced except in full, without prior written approval of the Company. Any unauthorized alteration, forgery or falsification of the content or appearance of this document is unlawful and offenders may be prosecuted to the fullest extent of the law. Unless otherwise stated the results shown in this test report refer only to the sample(s) tested.

Attention: To check the authenticity of testing/inspection report & certificate, please contact us at telephone: (86-755) 8307 1443, or email: CN.Doccheck@sgs.com

3rd Building, No. 889 Yishan Road Xuhui District, Shanghai China 200233 | E&E (86-21) 61402553 | F&E (86-21) 64953679 | www.sgs.com
中国·上海·徐汇区宜山路889号3号楼 邮编: 200233 | TL (86-21) 61402594 | HL (86-21) 61156899 | sgs.china@sgs.com

Member of the SGS Group (SGS SA)



检测报告

编号: SHAEC24008425816

日期: 2024年05月07日

第5页, 共8页

附件:

1.0, SH, SHD, 1.25, 51021, DF14, DF13, GH, ZH, PH, PHB, PA, PHSD, DF11, C1251, 51047, 51146, FI-S, PHD, YHD200, PA, SMP, SMW, SMH, SMH200, SMH200-H, YH200, 20039WR, 杜邦2.0, XH/TJC3, XA, HA, XHB, XHD, XHE, EH, EI, 小四P, 5263, 5264, 5267, 5268, SZN, SAN, SCN, SCND, JC15, JC20, JC25, 5102, 5240, SMH250, SMP250, SMW250, 25048HS, 25045HP, SM, TJC8, 杜邦2.54, TJC8A, 杜邦带锁, TJC8B, TJC8H, 5051, 2510, 美尚美, 43640, 43645, 43020, 43025, 5500, 5600, VH, VHRR, YH396, VHR, 35156, 2139, 3.96, 90331, 5195, 5196, 39612, FL, 5557, 5559, 5566, 5569, SL, RV42, EL, YL, 小EL, 8981, 大四P, 5058, 5.08, L6.2, VL, VLP/VLR, TJC2, TJC2A, TJC2B, TJC4, TJC1, 1806, MX3.0, 1.58, 51005, 51006, BH3.5, BH4.0, 63080, 51004, TJC15, A4203, CL014, OTP, MKH, SMF, Cy-X201, 35108, 35150, 35151, 35224, 35180, 35965, 42021, 42022, 42002, 35955, SA, SCS, 35189, 35196, CH10, CH2.5, 543, SLP, SLR, YHL500, YWL500, FFC, FPC, 20030, 250, LGC, S11, YH025, 35155, 25415, 5197, 5198, 110, 2.8, 6.3, SCS NH, XHQ, 42474, 42475, QH, NV, 50300, 50301, 5025, 3191, 5199, STV5, YHL500, YWL500, F001, F002, D440, D600, D620, D700, D220, D230, D250, D480, D520, D280, D630, D430, D400, D450, U-T, F1001-T, SIN-T, 774, 773, 778, 294, TU-JTK(SV), TU(SNB), TO-JTK(RV), MDD, FDD, TG-JT, IDC, AUTO, CONNECTOR, DJ70, DT04, DT06, UY/K1, UY2/K2, UR/K3, UR2, UB/K4, UB2A, UG/K5, U1R/K8, U1B/K9, HJKT10, UDW2, 314, A5001, A5002, MC100, FPC2.54, SGN, PHR, ZHR, 205, 5.2, C1801, C1802, 2060, A5003, ME020, ME010, FPC/FFC, B2541, 1971845, 1971846, 2232043, 2232044, 2232511, 1971895, 1971896, JWPF, SY, Molex1.5, ME0100, RAST, A5004, DV, SJN, SDN, 35182, 35524, RCY, LC, VR, SHJ, SHL, DF19, ACH, IL-Z, SATA, XSR, SUR, SUH, ZE, ZND, ZPD, SFH, PUD, AMP2.0, 35507, DF3, PND, RE, RA, RF, SYP/SYR, HIF3, MC100/ME020/ME010, F2541, VHB, VHC, VHD SHB1.0, NHB1.0, FIS, VHE, 35313, 30PIN, PR9-409, PR5-70-1, PR5-24, 5240B, 5500B, 5600B, 13006, 13007, 3DLG06FW, 1719057, 1719058, 1719059, CS28H, 9102501, 9103101, 9111001, PP0311401, 33EMMT26FBK, 3CN2BH02, 3FW06FBM, PP0426613, PP0426202, GIC3.3, 1376421-1, XADR, XADRR, 179846, 179849, XHR, 50235, PAD, PNI, SDL2.5, PS-250-2A-15, 4.8, 62306, H9002, DC4235, 62308, 62420-1, B35E0, 63658-1, 1060-16-0122, RH0409000142, RH011810030061, RH040499000142, RH011810030090, 299900421692, 33146412, 1.25 插板, SPS-01T-110, 282104-1, 282105-1, 282110-1, 282109-1, 21T1000501, 20T1001001, PP043531T, XNIRP, XL, 1123343-1, DF16, 1473413-1, 12147302, MG641234-5, PHBS,0.8, Molex1.2, 35746, 35748, APM2.54

1969738, 1969740, 1971845, 1971846, 1971895, 1971896, 1971946 thru 1971949, 1971954 thru 1971957, 2232008 thru 2232011, 2232000 thru 2232003, 2232016 thru 2232019, 1971962 thru 1971965, 2232024 thru 2232027, 2232289 thru 2232292, 2232043 thru 2232074, 2232298 thru 2232301, 2232511, 2232532, 2232557, 2232559, 2232560, 2232562, 2232563, 2232565, 2232566, 2232568, 2232569, 2232571, 2232572, 2232574, 2232575, 2232577, 2232578, 2232580, 2232581, 2232583, 2232584, 2232586, 2232587, 2232589, 2232590, 2232592, 2232593, 2232595, 2232596, 2232598, 2232599, 2232601, 2232602, 2232604, 2232605, 2232607, 2232608, 2232611 thru 2232682, 2292457, 2292458, 1064,2064,3064,1080,2080,3080,1100,2100,3100,1120, 2120,3120,1150,2150,3150, 1180,2180,3180,1230,2230, 3230,1250,2250,3250,1280,2280,3280,1300,2300,3300, 1480,2480,3480, 1630,2630,3630,1780,2780,3780,1950, 2950,3950,1010,2010,3010,1013,2013,3013,1015,2015, 3015, 1016,2016,3016,1025,2025,3025,1035,2035,3035, 1045,2045,3045,1058,2058,3058,1999,2999,3999, 401,402,403,503,TPA,BX,CPA, 404, 501, 502 A1001 A1002 A1003 A1004 A1005 A1006 A1007 A1008 A1009 A1251 A1252 A1253 A1254 A1255 A1256 A1257 A1258 A1259 A1501 A1502 A1503 A1504 A1505 A1506 A1507 A1508 A1509 A2001 A2002 A2003 A2004 A2005 A2006 A2007 A2008 A2009



Unless otherwise agreed in writing, this document is issued by the Company subject to its General Conditions of Service printed overleaf, available on request or accessible at http://www.sgs.com/en/Terms-and-Conditions.aspx and, for electronic format documents, subject to Terms and Conditions for Electronic Documents at http://www.sgs.com/en/Terms-and-Conditions/Terms-e-Document.aspx. Attention is drawn to the limitation of liability, indemnification and jurisdiction issues defined therein. Any holder of this document is advised that information contained hereon reflects the Company's findings at the time of its intervention only and within the limits of Client's instructions, if any. The Company's sole responsibility is to its Client and this document does not exonerate parties to a transaction from exercising all their rights and obligations under the transaction documents. This document cannot be reproduced except in full, without prior written approval of the Company. Any unauthorized alteration, forgery or falsification of the content or appearance of this document is unlawful and offenders may be prosecuted to the fullest extent of the law. Unless otherwise stated the results shown in this test report refer only to the sample(s) tested. Attention: To check the authenticity of testing inspection report & certificate, please contact us at telephone: (86-755) 8307 1443, or email: CN.Doccheck@sgs.com 3rd Building No.889 Yishan Road Xuhui District, Shanghai China 200233 tE&E (86-21) 61402553 fE&E (86-21) 64953679 www.sgs.com.cn 中国·上海·徐汇区宜山路889号3号楼 邮编: 200233 tHL (86-21) 61402594 fHL (86-21) 61156899 e sgs.china@sgs.com

Member of the SGS Group (SGS SA)





检测报告

编号: SHAEC24008425816

日期: 2024年05月07日

第6页, 共8页

A2010 A2011 A2012 A2013 A2014 A2015 A2016 A2017 A2018
A2501 A2502 A2503 A2504 A2505 A2506 A2507 A2508 A2509
A25010 A25011 A25012 A25013 A25014 A25015 A25016 A25017 A25018
A2541 A2542 A2543 A2544 A2545 A2546 A2547 A2548 A2549
A3001 A3002 A3003 A3004 A3005 A3006 A3007 A3008 A3009
A3301 A3302 A3303 A3304 A3305 A3306 A3307 A3308 A3309
A3961 A3962 A3963 A3964 A3965 A3966 A3967 A3968 A3969
A4201 A4202 A4203 A4204 A4205 A4206 A4207 A4208 A4209
A5001 A5002 A5003 A5004 A5005 A5006 A5007 A5008 A5009
A5081 A5082 A5083 A5084 A5085 A5086 A5087 A5088 A5089
A6501 A6502 A6503 A6504 A6505 A6506 A6507 A6508 A6509
B1251 B1252 B1253 B1254 B1255 B1256 B1257 B1258 B1259
B1501 B1502 B1503 B1504 B1505 B1506 B1507 B1508 B1509
B2001 B2002 B2003 B2004 B2005 B2006 B2007 B2008 B2009
B2501 B2502 B2503 B2504 B2505 B2506 B2507 B2508 B2509
B2541 B2542 B2543 B2544 B2545 B2546 B2547 B2548 B2549
B76201 B76202 B76203 B76204 B76205 B76206 B76207 B76208 B76209
B13001 B13002 B13003 B13004 B13005 B13006 B13007 B13008 B13009
C01581 C01582 C01583 C01584 C01585 C01586 C01587 C01588 C01589
C1251 C1252 C1253 C1254 C1255 C1256 C1257 C1258 C1259
C1501 C1502 C1503 C1504 C1505 C1506 C1507 C1508 C1509
C2001 C2002 C2003 C2004 C2005 C2006 C2007 C2008 C2009
C2501 C2502 C2503 C2504 C2505 C2506 C2507 C2508 C2509
C25010 C25011 C25012 C25013 C25014 C25015 C25016 C25017 C25018
C2541 C2542 C2543 C2544 C2545 C2546 C2547 C2548 C2549
C3001 C3002 C3003 C3004 C3005 C3006 C3007 C3008 C3009
C3501 C3502 C3503 C3504 C3505 C3506 C3507 C3508 C3509
C3681 C3682 C3683 C3684 C3685 C3686 C3687 C3688 C3689
C3961 C3962 C3963 C3964 C3965 C3966 C3967 C3968 C3969
C4001 C4002 C4003 C4004 C4005 C4006 C4007 C4008 C4009
C4141 C4142 C4143 C4144 C4145 C4146 C4147 C4148 C4149
C4201 C4202 C4203 C4204 C4205 C4206 C4207 C4208 C4209
C4501 C4502 C4503 C4504 C4505 C4506 C4507 C4508 C4509
C5001 C5002 C5003 C5004 C5005 C5006 C5007 C5008 C5009
C6201 C6202 C6203 C6204 C6205 C6206 C6207 C6208 C6209
C6351 C6352 C6353 C6354 C6355 C6356 C6357 C6358 C6359
D2801 D2802 D2803 D2804 D2805 D2806 D2807 D2808 D2809
D4801 D4802 D4803 D4804 D4805 D4806 D4807 D4808 D4809
D5201 D5202 D5203 D5204 D5205 D5206 D5207 D5208 D5209
D6301 D6302 D6303 D6304 D6305 D6306 D6307 D6308 D6309
D6201 D6202 D6203 D6204 D6205 D6206 D6207 D6208 D6209
D7001 D7002 D7003 D7004 D7005 D7006 D7007 D7008 D7009
F0501 F0502 F0503 F0504 F0505 F0506 F0507 F0508 F0509
F05010 F05011 F05012 F05013 F05014 F05015 F05016 F05017 F05018
F1001 F1002 F1003 F1004 F1005 F1006 F1007 F1008 F1009
F10010 F10011 F10012 F10013 F10014 F10015 F10016 F10017 F10018
F2541 F2542 F2543 F2544 F2545 F2546 F2547 F2548 F2549
P0001 P0002 P0003 P0004 P0005 P0006 P0007 P0008 P0009
P0010 P0011 P0012 P0013 P0014 P0015 P0016 P0017 P0018
P0019 P0020 P0021 P0022 P0023 P0024 P0025 P0026 P0027

上海
印章
Servic
SGS



Unless otherwise agreed in writing, this document is issued by the Company subject to its General Conditions of Service printed overleaf, available on request or accessible at <http://www.sgs.com/en/Terms-and-Conditions.aspx> and, for electronic format documents, subject to Terms and Conditions for Electronic Documents at <http://www.sgs.com/en/Terms-and-Conditions/Terms-e-Documents.aspx>. Attention is drawn to the limitation of liability, indemnification and jurisdiction issues defined therein. Any holder of this document is advised that information contained hereon reflects the Company's findings at the time of its intervention only and within the limits of Client's instructions, if any. The Company's sole responsibility is to its Client and this document does not exonerate parties to a transaction from exercising all their rights and obligations under the transaction documents. This document cannot be reproduced except in full, without prior written approval of the Company. Any unauthorized alteration, forgery or falsification of the content or appearance of this document is unlawful and offenders may be prosecuted to the fullest extent of the law. Unless otherwise stated the results shown in this test report refer only to the sample(s) tested.
Attention: To check the authenticity of testing/inspection report & certificate, please contact us at telephone: (86-755) 8307 1443, or email: CN.Doccheck@sgs.com
3rd Building No.889 Yishan Road Xuhui District, Shanghai China 200233 tE&E (86-21) 61402553 fE&E (86-21) 64953679 www.sgs.com.cn
中国·上海·徐汇区宜山路889号3号楼 邮编: 200233 tHL (86-21) 61402594 fHL (86-21) 61156899 e sgs.china@sgs.com

Member of the SGS Group (SGS SA)



检测报告

编号: SHAEC24008425816

日期: 2024年05月07日

第7页, 共8页

D2301 D2302 D2303 D2304 D2305 D2306 D2307 D2308 D2309
 D6001 D6002 D6003 D6004 D6005 D6006 D6007 D6008 D6009
 D2201 D2202 D2203 D2204 D2205 D2206 D2207 D2208 D2209
 B10901 B13601 C6001 C6002 C6003 C6004 A20010 A20011 P0028
 P0029 P0030 P0031 B11001 C2201 C2202 C4101 C6701 C6702
 D630J D700G A20012 P0032 B4001 A0801 A1271 A1803
 A10001 A4141 A7501 A7502 A3501 A1201 A4001 A6351 B14501
 A20013 A1202 D2501 A1801 A1802



Unless otherwise agreed in writing, this document is issued by the Company subject to its General Conditions of Service printed overleaf, available on request or accessible at <http://www.sgs.com/en/Terms-and-Conditions.aspx> and, for electronic format documents, subject to Terms and Conditions for Electronic Documents at <http://www.sgs.com/en/Terms-and-Conditions/Terms-e-Documents.aspx>. Attention is drawn to the limitation of liability, indemnification and jurisdiction issues defined therein. Any holder of this document is advised that information contained hereon reflects the Company's findings at the time of its intervention only and within the limits of Client's instructions, if any. The Company's sole responsibility is to its Client and this document does not exonerate parties to a transaction from exercising all their rights and obligations under the transaction documents. This document cannot be reproduced except in full, without prior written approval of the Company. Any unauthorized alteration, forgery or falsification of the content or appearance of this document is unlawful and offenders may be prosecuted to the fullest extent of the law. Unless otherwise stated the results shown in this test report refer only to the sample(s) tested.

Attention: To check the authenticity of testing inspection report & certificate, please contact us at telephone: (86-755) 8307 1443, or email: CN.Doccheck@sgs.com

3rd Building, No. 889 Yishan Road Xuhui District, Shanghai China 200233 t E&E (86-21) 61402553 f E&E (86-21) 64953679 www.sgs.com.cn
 中国·上海·徐汇区宜山路889号3号楼 邮编: 200233 t HL (86-21) 61402594 f HL (86-21) 61156899 e sgs.china@sgs.com

Member of the SGS Group (SGS SA)



检测报告

编号: SHAEC24008425816

日期: 2024年05月07日

第8页, 共8页

样品照片:

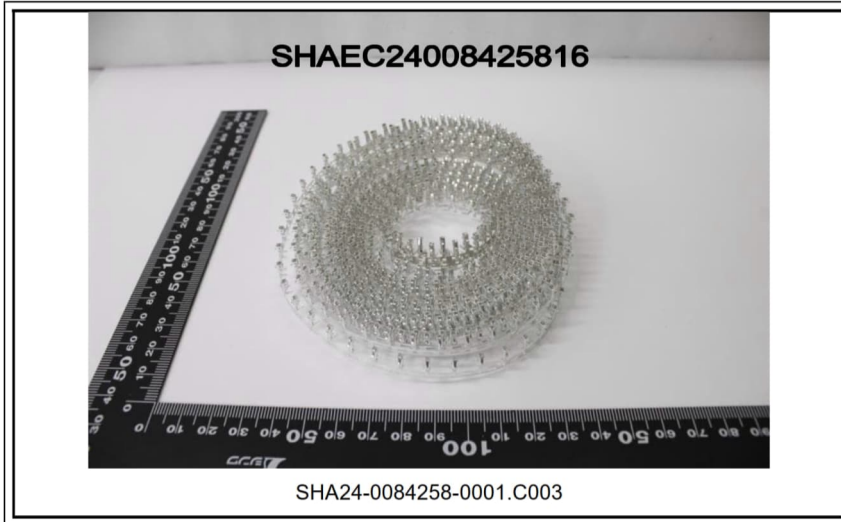

此照片仅限于随 SGS 正本报告使用
报告结束



Unless otherwise agreed in writing, this document is issued by the Company subject to its General Conditions of Service printed overleaf, available on request or accessible at <http://www.sgs.com/en/Terms-and-Conditions.aspx> and, for electronic format documents, subject to Terms and Conditions for Electronic Documents at <http://www.sgs.com/en/Terms-and-Conditions/Terms-e-Documents.aspx>. Attention is drawn to the limitation of liability, indemnification and jurisdiction issues defined therein. Any holder of this document is advised that information contained hereon reflects the Company's findings at the time of its intervention only and within the limits of Client's instructions, if any. The Company's sole responsibility is to its Client and this document does not exonerate parties to a transaction from exercising all their rights and obligations under the transaction documents. This document cannot be reproduced except in full, without prior written approval of the Company. Any unauthorized alteration, forgery or falsification of the content or appearance of this document is unlawful and offenders may be prosecuted to the fullest extent of the law. Unless otherwise stated the results shown in this test report refer only to the sample(s) tested.

Attention: To check the authenticity of testing / inspection report & certificate, please contact us at telephone: (86-755) 8307 1443, or email: CN.Doccheck@sgs.com

3rd Building, No. 889 Yishan Road Xuhui District, Shanghai China 200233 | E&E (86-21) 61402553 | F&E (86-21) 64953679 | www.sgs.com.cn
中国·上海·徐汇区宜山路889号3号楼 邮编: 200233 | HL (86-21) 61402594 | HL (86-21) 61156899 | e.sgs.china@sgs.com

Member of the SGS Group (SGS SA)



中国认可
国际互认
检测
TESTING
CNAS L0599

检测报告

编号: SHAEC24008219302

日期: 2024年04月29日

第1页, 共11页

客户名称: 浙江联和电子有限公司
客户地址: 浙江省乐清市乐清湾港区乐商创业园
浙江省乐清市乐清湾港区电子信息产业园红旗路8号

样品名称: LCP 连接器
型号: 1.25-4AB
客户参考信息: 见附件
以上样品及信息由客户提供。

SGS 工作编号: TIC1020240423173125DXY5
样品接收时间: 2024年04月24日
检测周期: 2024年04月24日 ~ 2024年04月29日
检测要求: 根据客户要求检测。
检测方法: 见后续页。
检测结果: 见后续页。

检测要求	结论
欧盟 RoHS 指令 2011/65/EU 附录 II 的修正指令(EU) 2015/863-铅、汞、镉、六价铬、多溴联苯 (PBB)、多溴二苯醚 (PBDE)、邻苯二甲酸二(2-乙基己基)酯 (DEHP)、邻苯二甲酸丁苄酯 (BBP)、邻苯二甲酸二丁酯 (DBP)和邻苯二甲酸二异丁酯 (DIBP)	符合

通标标准技术服务(上海)有限公司
授权签名

Jenny Lan 兰柳珍
批准签署人



Unless otherwise agreed in writing, this document is issued by the Company subject to its General Conditions of Service printed overleaf, available on request or accessible at <http://www.sgs.com/en/Terms-and-Conditions.aspx> and, for electronic format documents, subject to Terms and Conditions for Electronic Documents at <http://www.sgs.com/en/Terms-and-Conditions/Terms-e-Documents.aspx>. Attention is drawn to the limitation of liability, indemnification and jurisdiction issues defined therein. Any holder of this document is advised that information contained hereon reflects the Company's findings at the time of its intervention only and within the limits of Client's instructions, if any. The Company's sole responsibility is to its Client and this document does not exonerate parties to a transaction from exercising all their rights and obligations under the transaction documents. This document cannot be reproduced except in full, without prior written approval of the Company. Any unauthorized alteration, forgery or falsification of the content or appearance of this document is unlawful and offenders may be prosecuted to the fullest extent of the law. Unless otherwise stated the results shown in this test report refer only to the sample(s) tested.
Attention: To check the authenticity of testing/inspection report & certificate, please contact us at telephone: (86-755) 8307 1443, or email: CN.Doccheck@sgs.com
3rd Building No.889 Yishan Road Xuhui District, Shanghai China 200233 tE&E (86-21) 61402553 fE&E (86-21) 64953679 www.sgs.com
中国·上海·徐汇区宜山路889号3号楼 邮编: 200233 tHL (86-21) 61402594 fHL (86-21) 61156899 e sgs.china@sgs.com

Member of the SGS Group (SGS SA)



检测报告

编号: SHAEC24008219302

日期: 2024年04月29日

第2页, 共11页

检测结果:

检测部件外观描述:

样品序号	样品编号	SGS 样品 ID	样品描述
SN1	A1	SHA24-0082193-0001.C001	米色塑料部分

备注:

- (1) 1 mg/kg = 1 ppm = 0.0001%
- (2) MDL= 方法检测限
- (3) ND = 未检出 (< MDL)
- (4) "-" = 未规定

欧盟 RoHS 指令 2011/65/EU 附录 II 的修正指令(EU) 2015/863-铅、汞、镉、六价铬、多溴联苯 (PBB)、多溴二苯醚 (PBDE)、邻苯二甲酸二(2-乙基己基)酯 (DEHP)、邻苯二甲酸丁苄酯 (BBP)、邻苯二甲酸二丁酯 (DBP)和邻苯二甲酸二异丁酯 (DIBP)

检测方法: 参考 IEC 62321-4:2013+AMD1:2017, IEC 62321-5:2013, IEC 62321-7-2:2017, IEC 62321-6:2015 和 IEC 62321-8:2017, 采用 ICP-OES/AAS, UV-Vis 和 GC-MS 进行分析。

检测项目	限值	单位	MDL	A1
铅 (Pb)	1000	mg/kg	2	7
汞 (Hg)	1000	mg/kg	2	ND
镉 (Cd)	100	mg/kg	2	ND
六价铬 (Cr(VI))	1000	mg/kg	8	ND
多溴联苯之和 (PBB)	1000	mg/kg	-	ND
一溴联苯 (MonoBB)	-	mg/kg	5	ND
二溴联苯 (DiBB)	-	mg/kg	5	ND
三溴联苯 (TriBB)	-	mg/kg	5	ND
四溴联苯 (TetraBB)	-	mg/kg	5	ND
五溴联苯 (PentaBB)	-	mg/kg	5	ND
六溴联苯 (HexaBB)	-	mg/kg	5	ND
七溴联苯 (HeptaBB)	-	mg/kg	5	ND
八溴联苯 (OctaBB)	-	mg/kg	5	ND
九溴联苯 (NonaBB)	-	mg/kg	5	ND
十溴联苯 (DecaBB)	-	mg/kg	5	ND
多溴二苯醚之和 (PBDE)	1000	mg/kg	-	ND
一溴二苯醚 (MonoBDE)	-	mg/kg	5	ND
二溴二苯醚 (DiBDE)	-	mg/kg	5	ND
三溴二苯醚 (TriBDE)	-	mg/kg	5	ND
四溴二苯醚 (TetraBDE)	-	mg/kg	5	ND
五溴二苯醚 (PentaBDE)	-	mg/kg	5	ND
六溴二苯醚 (HexaBDE)	-	mg/kg	5	ND
七溴二苯醚 (HeptaBDE)	-	mg/kg	5	ND
八溴二苯醚 (OctaBDE)	-	mg/kg	5	ND



Unless otherwise agreed in writing, this document is issued by the Company subject to its General Conditions of Service printed overleaf, available on request or accessible at <http://www.sgs.com/en/Terms-and-Conditions.aspx> and, for electronic format documents, subject to Terms and Conditions for Electronic Documents at <http://www.sgs.com/en/Terms-and-Conditions/Terms-e-Documents.aspx>. Attention is drawn to the limitation of liability, indemnification and jurisdiction issues defined therein. Any holder of this document is advised that information contained hereon reflects the Company's findings at the time of its intervention only and within the limits of Client's instructions, if any. The Company's sole responsibility is to its Client and this document does not exonerate parties to a transaction from exercising all their rights and obligations under the transaction documents. This document cannot be reproduced except in full, without prior written approval of the Company. Any unauthorized alteration, forgery or falsification of the content or appearance of this document is unlawful and offenders may be prosecuted to the fullest extent of the law. Unless otherwise stated the results shown in this test report refer only to the sample(s) tested.

Attention: To check the authenticity of testing/inspection report & certificate, please contact us at telephone: (86-755) 8307 1443, or email: CN.Doccheck@sgs.com

3rd Building, No. 889 Yishan Road Xuhui District, Shanghai China 200233 t E&E (86-21) 61402553 f E&E (86-21) 64953679 www.sgs.com.cn
 中国·上海·徐汇区宜山路889号3号楼 邮编: 200233 t HL (86-21) 61402594 f HL (86-21) 61156899 e sgs.china@sgs.com

Member of the SGS Group (SGS SA)



检测报告

编号: SHAEC24008219302

日期: 2024年04月29日

第3页, 共11页

检测项目	限值	单位	MDL	A1
九溴二苯醚 (NonaBDE)	-	mg/kg	5	ND
十溴二苯醚 (DecaBDE)	-	mg/kg	5	ND
邻苯二甲酸二(2-乙基己基)酯 (DEHP)	1000	mg/kg	50	ND
邻苯二甲酸丁基酯 (BBP)	1000	mg/kg	50	ND
邻苯二甲酸二丁酯 (DBP)	1000	mg/kg	50	ND
邻苯二甲酸二异丁酯 (DIBP)	1000	mg/kg	50	ND

备注:

(1) 最大允许限值引用自 RoHS 指令(EU) 2015/863。

(2) IEC 62321 系列等同于 EN 62321 系列。

(3) 2021年7月22日开始, DEHP, BBP, DBP 和 DIBP 的限制适用于医疗器械, 包括体外医疗器械, 监控仪表, 包括工业监测和控制仪器。

除非另有说明, 参照 ILAC-G8:09/2019, 使用简单接受 ($w=0$) 的二元判定规则进行符合性判定。

除非另有说明, 此报告结果仅对检测的样品负责。本报告未经本公司书面许可, 不可部分复制。

Inspection
Stamp



Unless otherwise agreed in writing, this document is issued by the Company subject to its General Conditions of Service printed overleaf, available on request or accessible at <http://www.sgs.com/en/Terms-and-Conditions.aspx> and, for electronic format documents, subject to Terms and Conditions for Electronic Documents at <http://www.sgs.com/en/Terms-and-Conditions/Terms-e-Documents.aspx>. Attention is drawn to the limitation of liability, indemnification and jurisdiction issues defined therein. Any holder of this document is advised that information contained hereon reflects the Company's findings at the time of its intervention only and within the limits of Client's instructions, if any. The Company's sole responsibility is to its Client and this document does not exonerate parties to a transaction from exercising all their rights and obligations under the transaction documents. This document cannot be reproduced except in full, without prior written approval of the Company. Any unauthorized alteration, forgery or falsification of the content or appearance of this document is unlawful and offenders may be prosecuted to the fullest extent of the law. Unless otherwise stated the results shown in this test report refer only to the sample(s) tested.

Attention: To check the authenticity of testing/inspection report & certificate, please contact us at telephone: (86-755) 8307 1443, or email: CN.Doccheck@sgs.com
3rd Building, No. 889 Yishan Road Xuhui District, Shanghai China 200233 t E&E (86-21) 61402553 f E&E (86-21) 64953679 www.sgs.com.cn
中国·上海·徐汇区宜山路889号3号楼 邮编: 200233 t HL (86-21) 61402594 f HL (86-21) 61156899 e sgs.china@sgs.com

Member of the SGS Group (SGS SA)



检测报告

编号: SHAEC24008219302

日期: 2024年04月29日

第4页, 共11页

附件

元素检测流程图

样品按照下述流程被完全消解

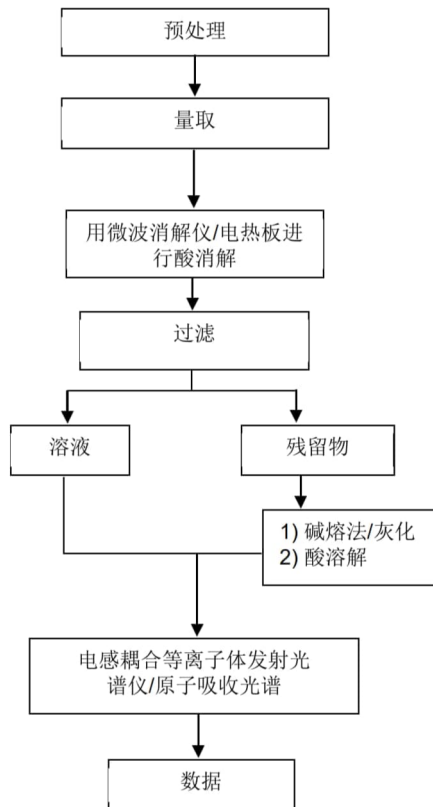

检测



Unless otherwise agreed in writing, this document is issued by the Company subject to its General Conditions of Service printed overleaf, available on request or accessible at <http://www.sgs.com/en/Terms-and-Conditions.aspx> and, for electronic format documents, subject to Terms and Conditions for Electronic Documents at <http://www.sgs.com/en/Terms-and-Conditions/Terms-e-Document.aspx>. Attention is drawn to the limitation of liability, indemnification and jurisdiction issues defined therein. Any holder of this document is advised that information contained hereon reflects the Company's findings at the time of its intervention only and within the limits of Client's instructions, if any. The Company's sole responsibility is to its Client and this document does not exonerate parties to a transaction from exercising all their rights and obligations under the transaction documents. This document cannot be reproduced except in full, without prior written approval of the Company. Any unauthorized alteration, forgery or falsification of the content or appearance of this document is unlawful and offenders may be prosecuted to the fullest extent of the law. Unless otherwise stated the results shown in this test report refer only to the sample(s) tested.

Attention: To check the authenticity of testing/inspection report & certificate, please contact us at telephone: (86-755) 8307 1443, or email: CN.Doccheck@sgs.com

3rd Building, No. 889 Yishan Road Xuhui District, Shanghai China 200233 t E&E (86-21) 61402553 f E&E (86-21) 64953679 www.sgs.com.cn
中国·上海·徐汇区宜山路889号3号楼 邮编: 200233 t HL (86-21) 61402594 f HL (86-21) 61156899 e sgs.china@sgs.com

Member of the SGS Group (SGS SA)



检测报告

编号: SHAEC24008219302

日期: 2024年04月29日

第5页, 共11页

附件

六价铬检测流程图

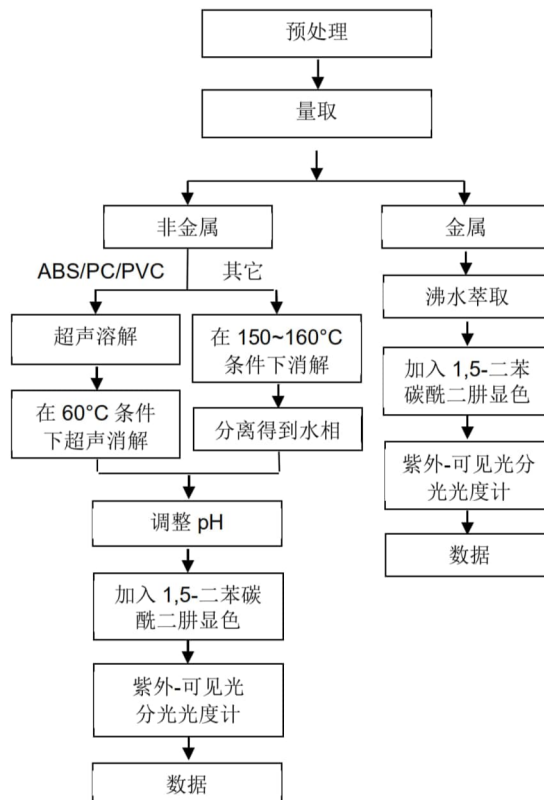

服
金检
in &
Techn



Unless otherwise agreed in writing, this document is issued by the Company subject to its General Conditions of Service printed overleaf, available on request or accessible at <http://www.sgs.com/en/Terms-and-Conditions.aspx> and, for electronic format documents, subject to Terms and Conditions for Electronic Documents at <http://www.sgs.com/en/Terms-and-Conditions/Terms-e-Documents.aspx>. Attention is drawn to the limitation of liability, indemnification and jurisdiction issues defined therein. Any holder of this document is advised that information contained hereon reflects the Company's findings at the time of its intervention only and within the limits of Client's instructions, if any. The Company's sole responsibility is to its Client and this document does not exonerate parties to a transaction from exercising all their rights and obligations under the transaction documents. This document cannot be reproduced except in full, without prior written approval of the Company. Any unauthorized alteration, forgery or falsification of the content or appearance of this document is unlawful and offenders may be prosecuted to the fullest extent of the law. Unless otherwise stated the results shown in this test report refer only to the sample(s) tested.
Attention: To check the authenticity of testing/inspection report & certificate, please contact us at telephone: (86-755) 8307 1443, or email: CN.Doccheck@sgs.com
3rd Building, No. 889 Yishan Road Xuhui District, Shanghai China 200233 | E&E (86-21) 61402553 | F&E (86-21) 64953679 | www.sgs.com
中国·上海·徐汇区宜山路889号3号楼 邮编: 200233 | HL (86-21) 61402594 | HL (86-21) 61156899 | sgs.china@sgs.com

Member of the SGS Group (SGS SA)



检测报告

编号: SHAEC24008219302

日期: 2024年04月29日

第6页, 共11页

附件

PBB/PBDE 检测流程图

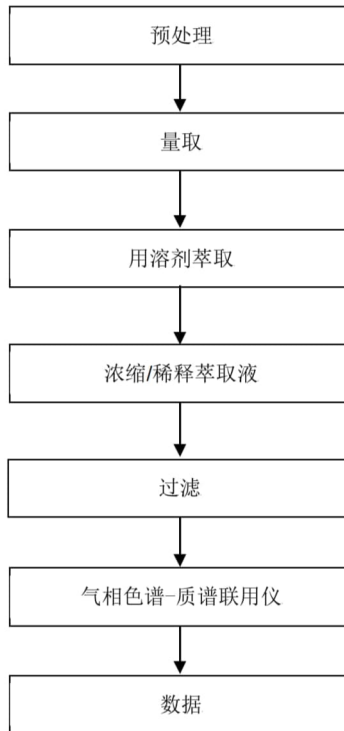

任务
测试
数据



Unless otherwise agreed in writing, this document is issued by the Company subject to its General Conditions of Service printed overleaf, available on request or accessible at <http://www.sgs.com/en/Terms-and-Conditions.aspx> and, for electronic format documents, subject to Terms and Conditions for Electronic Documents at <http://www.sgs.com/en/Terms-and-Conditions/Terms-e-Documents.aspx>. Attention is drawn to the limitation of liability, indemnification and jurisdiction issues defined therein. Any holder of this document is advised that information contained hereon reflects the Company's findings at the time of its intervention only and within the limits of Client's instructions, if any. The Company's sole responsibility is to its Client and this document does not exonerate parties to a transaction from exercising all their rights and obligations under the transaction documents. This document cannot be reproduced except in full, without prior written approval of the Company. Any unauthorized alteration, forgery or falsification of the content or appearance of this document is unlawful and offenders may be prosecuted to the fullest extent of the law. Unless otherwise stated the results shown in this test report refer only to the sample(s) tested.

Attention: To check the authenticity of testing/inspection report & certificate, please contact us at telephone: (86-755) 8307 1443, or email: CN.Doccheck@sgs.com

3rd Building, No. 889 Yishan Road Xuhui District, Shanghai China 200233 | E&E (86-21) 61402553 | F&E (86-21) 64953679 | www.sgs.com
中国·上海·徐汇区宜山路889号3号楼 邮编: 200233 | HL (86-21) 61402594 | HL (86-21) 61156899 | sgs.china@sgs.com

Member of the SGS Group (SGS SA)



检测报告

编号: SHAEC24008219302

日期: 2024年04月29日

第7页, 共11页

附件

Phthalates 检测流程图

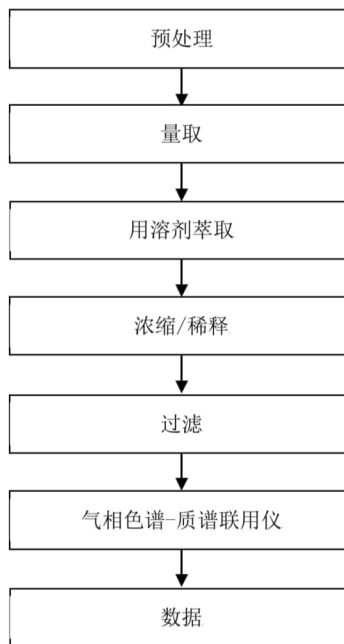

专用
ing
en



Unless otherwise agreed in writing, this document is issued by the Company subject to its General Conditions of Service printed overleaf, available on request or accessible at <http://www.sgs.com/en/Terms-and-Conditions.aspx> and, for electronic format documents, subject to Terms and Conditions for Electronic Documents at <http://www.sgs.com/en/Terms-and-Conditions/Terms-e-Documents.aspx>. Attention is drawn to the limitation of liability, indemnification and jurisdiction issues defined therein. Any holder of this document is advised that information contained hereon reflects the Company's findings at the time of its intervention only and within the limits of Client's instructions, if any. The Company's sole responsibility is to its Client and this document does not exonerate parties to a transaction from exercising all their rights and obligations under the transaction documents. This document cannot be reproduced except in full, without prior written approval of the Company. Any unauthorized alteration, forgery or falsification of the content or appearance of this document is unlawful and offenders may be prosecuted to the fullest extent of the law. Unless otherwise stated the results shown in this test report refer only to the sample(s) tested.

Attention: To check the authenticity of testing/inspection report & certificate, please contact us at telephone: (86-755) 8307 1443, or email: CN.Doccheck@sgs.com

3rd Building, No. 889 Yishan Road Xuhui District, Shanghai China 200233 t E&E (86-21) 61402553 f E&E (86-21) 64953679 www.sgs.com.cn
中国·上海·徐汇区宜山路889号3号楼 邮编: 200233 t HL (86-21) 61402594 f HL (86-21) 61156899 e sgs.china@sgs.com

Member of the SGS Group (SGS SA)



检测报告

编号: SHAEC24008219302

日期: 2024年04月29日

第8页, 共11页

附件:

1.0, SH, SHD, 1.25, 51021, DF14, DF13, GH, ZH, PH, PHB, PA, PHSD, DF11, C1251, 51047, 51146, FI-S, PHD, YHD200, PA, SMP, SMW, SMH, SMH200, SMH200-H, YH200, 20039WR, 杜邦 2.0, XH/TJC3, XA, HA, XHB, XHD, XHE, EH, EI, 小四 P, 5263, 5264, 5267, 5268, SZN, SAN, SCN, SCND, JC15, JC20, JC25, 5102, 5240, SMH250, SMP250, SMW250, 25048HS, 25045HP, SM, TJC8, 杜邦 2.54, TJC8A, 杜邦带锁, TJC8B, TJC8H, 5051, 2510, 美尚美, 43640, 43645, 43020, 43025, 5500, 5600, VH, VHRR, YH396, VHR, 35156, 2139, 3.96, 90331, 5195, 5196, 39612, FL, 5557, 5559, 5566, 5569, SL, RV42, EL, YL, 小 EL, 8981, 大四 P, 5058, 5.08, L6.2, VL, VLP/VLR, TJC2, TJC2A, TJC2B, TJC4, TJC1, 1806, MX3.0, 1.58, 51005, 51006, BH3.5, BH4.0, 63080, 51004, TJC15, A4203, CL014, OTP, MKH, SA, Cy-X201, 35108, 35150, 35151, 35152, 35180, 35965, 42021, 42022, 42002, 35955, SA, SCS, 35189, 35196, CH10, CH2.5, 543, SLP, SLR, YHL500, YWL500, FFC, FPC, 20030, 250, LGC, S11, YH025, 35155, 25415, 5197, 5198, 110, 2.8, 6.3, SCS

NH, XHQ, 42474, 42475, QH, NV, 50300, 50301, 5025, 3191, 5199, STV5, YHL500, YWL500, F001, F002, D440, D600, D620, D700, D220, D230, D250, D480, D520, D280, D630, D430, D400, D450, U-T, F1001-T, SIN-T, 774, 773, 778, 294, TU-JTK(SV), TU(SNB), TO-JTK(RV), MDD, FDD, TG-JT, IDC, AUTO, CONNECTOR, DJ70, DT04, DT06, UY/K1, UY2/K2, UR/K3, UR2, UB/K4, UB2A, UG/K5, U1R/K8, U1B/K9, HJKT10, UDW2, 314, A5001, A5002, MC100, FPC2.54, SGN, PHR, ZHR, 205, 5.2, C1801, C1802, 2060, A5003, ME020, ME010, FPC/FFC, B2541, 1971845, 1971846, 2232043, 2232044, 2232511, 1971895, 1971896, JWPF, SY, Molex1.5, ME0100, RAST, A5004, DV, SJN, SDN, 35182, 35524, RCY, LC, VR, SHJ, SHL, DF19, ACH, IL-Z, SATA, XSR, SUR, SUH, ZE, ZND, ZPD, SFH, PUD, AMP2.0, 35507, DF3, PND, RE, RA, RF, SYP/SYR, HIF3, MC100/ME020/ME010, F2541, VHB, VHC, VHD SHB1.0, NHB1.0, FIS, VHE, 35313, 30PIN, PR9-409, PR5-70-1, PR5-24, 5240B, 5500B, 5600B, 13006, 13007, 3DLG06FW, 1719057, 1719058, 1719059, CS28H, 9102501, 9103101, 9111001, PP0311401, 33EMMT26FBK, 3CN2BH02, 3FW06FBM, PP0426613, PP0426202, GIC3.3, 1376421-1, XADR, XADRR, 179846, 179849, XHR, 50235, PAD, PNI, SDL2.5, PS-250-2A-15, 4.8, 62306, H9002, DC4235, 62308, 62420-1, B35E0, 63658-1, 1060-16-0122, RH0409000142, RH011810030061, RH040499000142, RH011810030090, 299900421692, 33146412, 1.25 插板, SPS-01T-110, 282104-1, 282105-1, 282110-1, 282109-1, 21T1000501, 20T1001001, PP043531T, XNIRP, XL, 1123343-1, DF16, 1473413-1, 12147302, MG641234-5, PHBS,0.8, Molex1.2, 35746, 35748, APM2.54

1969738, 1969740, 1971845, 1971846, 1971895, 1971896, 1971946 thru 1971949, 1971954 thru 1971957, 2232008 thru 2232011, 2232000 thru 2232003, 2232016 thru 2232019, 1971962 thru 1971965, 2232024 thru 2232027, 2232289 thru 2232292, 2232043 thru 2232074, 2232298 thru 2232301, 2232511, 2232532, 2232557, 2232559, 2232560, 2232562, 2232563, 2232565, 2232566, 2232568, 2232569, 2232571, 2232572, 2232574, 2232575, 2232577, 2232578, 2232580, 2232581, 2232583, 2232584, 2232586, 2232587, 2232589, 2232590, 2232592, 2232593, 2232595, 2232596, 2232598, 2232599, 2232601, 2232602, 2232604, 2232605, 2232607, 2232608, 2232611 thru 2232682, 2292457, 2292458, 1064,2064,3064,1080,2080,3080,1100,2100,3100,1120, 2120,3120,1150,2150,3150, 1180,2180,3180,1230,2230, 3230,1250,2250,3250,1280,2280,3280,1300,2300,3300, 1480,2480,3480, 1630,2630,3630,1780,2780,3780,1950, 2950,3950,1010,2010,3010,1013,2013,3013,1015,2015, 3015, 1016,2016,3016,1025,2025,3025,1035,2035,3035, 1045,2045,3045,1058,2058,3058,1999,2999,3999, 401,402,403,503,TPA,BX,CPA, 404, 501, 502 A1001 A1002 A1003 A1004 A1005 A1006 A1007 A1008 A1009

章
印
效



Unless otherwise agreed in writing, this document is issued by the Company subject to its General Conditions of Service printed overleaf, available on request or accessible at <http://www.sgs.com/en/Terms-and-Conditions.aspx> and, for electronic format documents, subject to Terms and Conditions for Electronic Documents at <http://www.sgs.com/en/Terms-and-Conditions/Terms-e-Documents.aspx>. Attention is drawn to the limitation of liability, indemnification and jurisdiction issues defined therein. Any holder of this document is advised that information contained hereon reflects the Company's findings at the time of its intervention only and within the limits of Client's instructions, if any. The Company's sole responsibility is to its Client and this document does not exonerate parties to a transaction from exercising all their rights and obligations under the transaction documents. This document cannot be reproduced except in full, without prior written approval of the Company. Any unauthorized alteration, forgery or falsification of the content or appearance of this document is unlawful and offenders may be prosecuted to the fullest extent of the law. Unless otherwise stated the results shown in this test report refer only to the sample(s) tested.
Attention: To check the authenticity of testing/inspection report & certificate, please contact us at telephone: (86-755) 8307 1443, or email: CN.Doccheck@sgs.com
3rd Building No.889 Yishan Road Xuhui District, Shanghai China 200233 tE&E (86-21) 61402553 fE&E (86-21) 64953679 www.sgs.com.cn
中国·上海·徐汇区宜山路889号3号楼 邮编: 200233 tHL (86-21) 61402594 fHL (86-21) 61156899 e sgs.china@sgs.com

Member of the SGS Group (SGS SA)



检测报告

编号: SHAEC24008219302

日期: 2024年04月29日

第9页, 共11页

A1251 A1252 A1253 A1254 A1255 A1256 A1257 A1258 A1259
A1501 A1502 A1503 A1504 A1505 A1506 A1507 A1508 A1509
A2001 A2002 A2003 A2004 A2005 A2006 A2007 A2008 A2009
A2010 A2011 A2012 A2013 A2014 A2015 A2016 A2017 A2018
A2501 A2502 A2503 A2504 A2505 A2506 A2507 A2508 A2509
A25010 A25011 A25012 A25013 A25014 A25015 A25016 A25017 A25018
A2541 A2542 A2543 A2544 A2545 A2546 A2547 A2548 A2549
A3001 A3002 A3003 A3004 A3005 A3006 A3007 A3008 A3009
A3301 A3302 A3303 A3304 A3305 A3306 A3307 A3308 A3309
A3961 A3962 A3963 A3964 A3965 A3966 A3967 A3968 A3969
A4201 A4202 A4203 A4204 A4205 A4206 A4207 A4208 A4209
A5001 A5002 A5003 A5004 A5005 A5006 A5007 A5008 A5009
A5081 A5082 A5083 A5084 A5085 A5086 A5087 A5088 A5089
A6501 A6502 A6503 A6504 A6505 A6506 A6507 A6508 A6509
B1251 B1252 B1253 B1254 B1255 B1256 B1257 B1258 B1259
B1501 B1502 B1503 B1504 B1505 B1506 B1507 B1508 B1509
B2001 B2002 B2003 B2004 B2005 B2006 B2007 B2008 B2009
B2501 B2502 B2503 B2504 B2505 B2506 B2507 B2508 B2509
B2541 B2542 B2543 B2544 B2545 B2546 B2547 B2548 B2549
B76201 B76202 B76203 B76204 B76205 B76206 B76207 B76208 B76209
B13001 B13002 B13003 B13004 B13005 B13006 B13007 B13008 B13009
C01581 C01582 C01583 C01584 C01585 C01586 C01587 C01588 C01589
C1251 C1252 C1253 C1254 C1255 C1256 C1257 C1258 C1259
C1501 C1502 C1503 C1504 C1505 C1506 C1507 C1508 C1509
C2001 C2002 C2003 C2004 C2005 C2006 C2007 C2008 C2009
C2501 C2502 C2503 C2504 C2505 C2506 C2507 C2508 C2509
C25010 C25011 C25012 C25013 C25014 C25015 C25016 C25017 C25018
C2541 C2542 C2543 C2544 C2545 C2546 C2547 C2548 C2549
C3001 C3002 C3003 C3004 C3005 C3006 C3007 C3008 C3009
C3501 C3502 C3503 C3504 C3505 C3506 C3507 C3508 C3509
C3681 C3682 C3683 C3684 C3685 C3686 C3687 C3688 C3689
C3961 C3962 C3963 C3964 C3965 C3966 C3967 C3968 C3969
C4001 C4002 C4003 C4004 C4005 C4006 C4007 C4008 C4009
C4141 C4142 C4143 C4144 C4145 C4146 C4147 C4148 C4149
C4201 C4202 C4203 C4204 C4205 C4206 C4207 C4208 C4209
C4501 C4502 C4503 C4504 C4505 C4506 C4507 C4508 C4509
C5001 C5002 C5003 C5004 C5005 C5006 C5007 C5008 C5009
C6201 C6202 C6203 C6204 C6205 C6206 C6207 C6208 C6209
C6351 C6352 C6353 C6354 C6355 C6356 C6357 C6358 C6359
D2801 D2802 D2803 D2804 D2805 D2806 D2807 D2808 D2809
D4801 D4802 D4803 D4804 D4805 D4806 D4807 D4808 D4809
D5201 D5202 D5203 D5204 D5205 D5206 D5207 D5208 D5209
D6301 D6302 D6303 D6304 D6305 D6306 D6307 D6308 D6309
D6201 D6202 D6203 D6204 D6205 D6206 D6207 D6208 D6209
D7001 D7002 D7003 D7004 D7005 D7006 D7007 D7008 D7009
F0501 F0502 F0503 F0504 F0505 F0506 F0507 F0508 F0509
F05010 F05011 F05012 F05013 F05014 F05015 F05016 F05017 F05018
F1001 F1002 F1003 F1004 F1005 F1006 F1007 F1008 F1009
F10010 F10011 F10012 F10013 F10014 F10015 F10016 F10017 F10018
F2541 F2542 F2543 F2544 F2545 F2546 F2547 F2548 F2549
P0001 P0002 P0003 P0004 P0005 P0006 P0007 P0008 P0009
P0010 P0011 P0012 P0013 P0014 P0015 P0016 P0017 P0018

LHE
CES
04/29/24



Unless otherwise agreed in writing, this document is issued by the Company subject to its General Conditions of Service printed overleaf, available on request or accessible at <http://www.sgs.com/en/Terms-and-Conditions.aspx> and, for electronic format documents, subject to Terms and Conditions for Electronic Documents at <http://www.sgs.com/en/Terms-and-Conditions/Terms-e-Document.aspx>. Attention is drawn to the limitation of liability, indemnification and jurisdiction issues defined therein. Any holder of this document is advised that information contained hereon reflects the Company's findings at the time of its intervention only and within the limits of Client's instructions, if any. The Company's sole responsibility is to its Client and this document does not exonerate parties to a transaction from exercising all their rights and obligations under the transaction documents. This document cannot be reproduced except in full, without prior written approval of the Company. Any unauthorized alteration, forgery or falsification of the content or appearance of this document is unlawful and offenders may be prosecuted to the fullest extent of the law. Unless otherwise stated the results shown in this test report refer only to the sample(s) tested.

Attention: To check the authenticity of testing/inspection report & certificate, please contact us at telephone: (86-755) 8307 1443, or email: CN.Doccheck@sgs.com

3rd Building No.889 Yishan Road Xuhui District, Shanghai China 200233 tE&E (86-21) 61402553 fE&E (86-21) 64953679 www.sgs.com.cn
中国·上海·徐汇区宜山路889号3号楼 邮编: 200233 tHL (86-21) 61402594 fHL (86-21) 61156899 e sgs.china@sgs.com

Member of the SGS Group (SGS SA)



检测报告

编号: SHAEC24008219302

日期: 2024年04月29日

第 10 页, 共 11 页

P0019 P0020 P0021 P0022 P0023 P0024 P0025 P0026 P0027
D2301 D2302 D2303 D2304 D2305 D2306 D2307 D2308 D2309
D6001 D6002 D6003 D6004 D6005 D6006 D6007 D6008 D6009
D2201 D2202 D2203 D2204 D2205 D2206 D2207 D2208 D2209
B10901 B13601 C6001 C6002 C6003 C6004 A20010 A20011 P0028
P0029 P0030 P0031 B11001 C2201 C2202 C4101 C6701 C6702
D630J D700G A20012 P0032 B4001 A0801 A1271 A1803
A10001 A4141 A7501 A7502 A3501 A1201 A4001 A6351 B14501
A20013 A1202 D2501 A1801 A1802

有限公司



Unless otherwise agreed in writing, this document is issued by the Company subject to its General Conditions of Service printed overleaf, available on request or accessible at <http://www.sgs.com/en/Terms-and-Conditions.aspx> and, for electronic format documents, subject to Terms and Conditions for Electronic Documents at <http://www.sgs.com/en/Terms-and-Conditions/Terms-e-Document.aspx>. Attention is drawn to the limitation of liability, indemnification and jurisdiction issues defined therein. Any holder of this document is advised that information contained hereon reflects the Company's findings at the time of its intervention only and within the limits of Client's instructions, if any. The Company's sole responsibility is to its Client and this document does not exonerate parties to a transaction from exercising all their rights and obligations under the transaction documents. This document cannot be reproduced except in full, without prior written approval of the Company. Any unauthorized alteration, forgery or falsification of the content or appearance of this document is unlawful and offenders may be prosecuted to the fullest extent of the law. Unless otherwise stated the results shown in this test report refer only to the sample(s) tested.

Attention: to check the authenticity of testing/inspection report & certificate, please contact us at telephone: (86-755) 8307 1443, or email: CN.Doccheck@sgs.com
3rd Building, No.889 Yishan Road Xuhui District, Shanghai China 200233 t E&E (86-21) 61402553 f E&E (86-21) 64953679 www.sgs.com.cn
中国·上海·徐汇区宜山路889号3号楼 邮编: 200233 t HL (86-21) 61402594 f HL (86-21) 61156899 e sgs.china@sgs.com

Member of the SGS Group (SGS SA)



检测报告

编号: SHAEC24008219302

日期: 2024年04月29日

第 11 页, 共 11 页

样品照片:

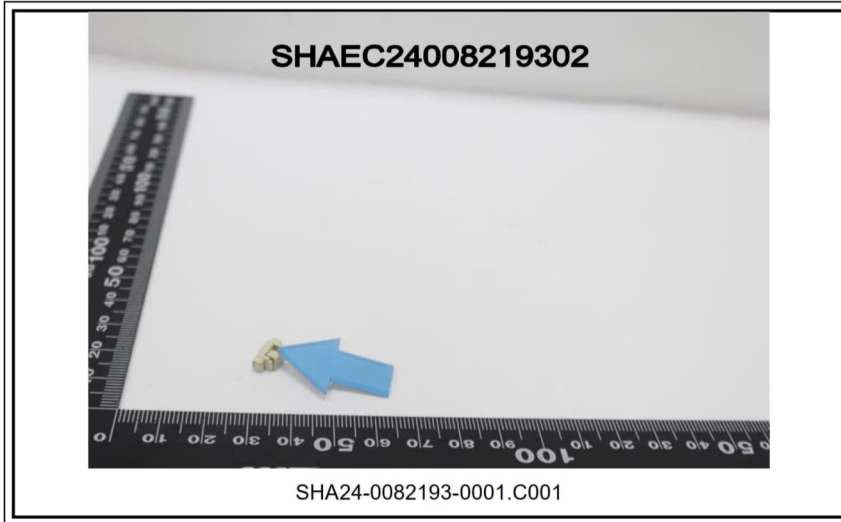

此照片仅限于随 SGS 正本报告使用
报告结束



Unless otherwise agreed in writing, this document is issued by the Company subject to its General Conditions of Service printed overleaf, available on request or accessible at <http://www.sgs.com/en/Terms-and-Conditions.aspx> and, for electronic format documents, subject to Terms and Conditions for Electronic Documents at <http://www.sgs.com/en/Terms-and-Conditions/Terms-e-Document.aspx>. Attention is drawn to the limitation of liability, indemnification and jurisdiction issues defined therein. Any holder of this document is advised that information contained hereon reflects the Company's findings at the time of its intervention only and within the limits of Client's instructions, if any. The Company's sole responsibility is to its Client and this document does not exonerate parties to a transaction from exercising all their rights and obligations under the transaction documents. This document cannot be reproduced except in full, without prior written approval of the Company. Any unauthorized alteration, forgery or falsification of the content or appearance of this document is unlawful and offenders may be prosecuted to the fullest extent of the law. Unless otherwise stated the results shown in this test report refer only to the sample(s) tested.

Attention: To check the authenticity of testing/inspection report & certificate, please contact us at telephone: (86-755) 8307 1443, or email: CN.Doccheck@sgs.com

3rd Building, No. 889 Yishan Road Xuhui District, Shanghai China 200233 | E&E (86-21) 61402553 | F&E (86-21) 64953679 | www.sgs.com
中国·上海·徐汇区宜山路889号3号楼 邮编: 200233 | HL (86-21) 61402594 | HL (86-21) 61156899 | sgs.china@sgs.com

Member of the SGS Group (SGS SA)

产品名称: PA66

版本日期: 15/03/2017

化学品安全说明书

MSDS

第一部分: 化学制品、产品或公司信息

产品名称: PA66

产品别名: 聚酰胺

责任方: 浙江联和电子有限公司

一般用途: 工程热塑性塑料

MSDS编号: PA66



第二部分: 合成物或成分信息

组成部分: 成分 CAS号码基础树脂 32131-17-2这是一种聚合物材料。所有成分和聚合物系统紧密结合, 因此, 目前正常的加工和处理情况下没有存在接触的可能性。本产品可能含有专利成分。根据美国《职业安全与卫生条例》, 本产品没有被归类为危险品, 此化学品安全说明书包含关于安全处理和合理使用本产品的有价值的信息。该说明书应妥善保管以便员工或其他使用该产品的用户使用。本产品不受加拿大《工作场所危险物质信息系统》管制。

第三部分: 危险鉴定

紧急情况概述: 轻微的不规则颗粒状。燃烧分解可能会产生有危害性的气体基础树脂粉尘或粉末在美国矿务局相关粉尘爆炸的危害等级为低级。熔料可能会导致皮肤或眼睛接触性的热灼伤。此外, 溢出的固体硬颗粒可能会造成滑倒的危险。

潜在健康影响: 接触方式: 皮肤和眼睛接触; 气体吸入, 如果温度过热的话。征兆症状: 没有相关的具体资料。

即刻健康影响:

皮肤: 本产品没有相关的具体资料。产品中可能含有的聚合物颗粒和纤维增强也可能造成机械性的伤害。热性或熔化材料有潜在的可能导致热灼伤。

眼睛: 本产品没有相关的具体资料。产品中可能含有的聚合物颗粒和纤维增强也可能造成机械性的伤害。

吸入: 本产品没有相关的具体资料。从供应的形式来看, 本产品不存在被吸入的危险; 然而聚合物颗粒可能被认为是一种惰性的微害颗粒。加热过程中可能会有产生刺激性气体的危险。

摄入: 本产品没有相关的具体资料。但是, 基于高分子聚合物的生物活性, 摄取本产品预计会造成轻微的毒性。

长期或滞后影响: 没有相关的具体资料。

致癌性: 国际癌症研究机构 (IARC) 曾评估过本产品中可能含有的碳黑, 并发现它可能对人类有致癌性 (2B组)。本产品中的任何碳黑成分都被聚合物体系紧密结合, 因此, 目前正常的加工和处理情况下致癌的几率很小。

医疗条件

风险加剧: 本产品没有相关的具体资料。废气可能会被释放, 如果过热的话, 会影响那些有呼吸系统慢性疾病的人。

第四部分：急救措施

皮肤：如果烫的或熔化的聚合物或者热气接触皮肤，迅速用冷水降温。如果聚合物被粘在皮肤上，不要擅自去除，但是允许粘附的聚合物自然脱落，应寻求医学处理。相比聚合物随着时间推移自行脱落而言，擅自去除粘在皮肤上的聚合物，可能会造成更多的组织损伤。

眼睛：用大量的水冲洗。如果仍旧不舒适，应寻求医疗处理，去除异物。

吸入：转移到空气新鲜之处。如果呼吸困难的情况仍然发生，应寻求医学处理。

摄入：如果相当数量的本产品被吞咽，应饮用两杯水来稀释，并寻求医学处理。

医生注意事项：本产品本质上是惰性和无毒的。然而，如果被加热到高温或被燃烧，可能会有气体排放出来（见第五和第十部分的气体排放）。在这些排放的气体中，一氧化碳和一氧化氮均有可能具有显著的临床毒性。那些曾暴露在有毒气体中的患者需要检查碳氧血红蛋白水平和动脉血气。如果一个酸中毒患者的碳氧血红蛋白水平是正常的，考虑氰化物毒性。如果患者与气体的接触发生在密闭空间内，则存在窒息（二氧化碳逐渐替代氧气）发生的可能性。一氧化氮对呼吸道有着强烈的刺激性。如果患者可能已经吸入高浓度和刺激性的烟雾，应考虑监测肺水肿病延后发生的可能。

第五部分：救火措施

闪点：不适用

危险燃烧产物：一氧化碳、二氧化碳和氮氧化物

灭火介质：水、泡沫材料、二氧化碳或干化学制

剂灭火指南：消防人员应携带自给式呼吸器和全套防护服。消防人员避免逆风救火。水应该用来给火灾中各种容器的降温。水、泡沫和干化学制剂可能会对电器设备造成损伤。

第六部分：意外泄漏对策

泄漏处理程序：用适当工具清扫泄漏场所，收集泄漏物料，以便恢复和处理。

第七部分：处理和储藏

处理：没有合适的器械，不要处理烫的或者熔化的物料。工作场所应保持整洁有序。不要超过推荐的温度，使分解产物的释放最小化。不要在有聚合物粉尘存在的场所抽烟。在传输和加工的过程中，应采取恰当的措施控制粉尘的产生和积累。

储藏：储藏在阴凉干燥的场所，保证树脂的干燥度。

第八部分：接触控制 / 个人防护

工程控制：局部排气：建议在适当的时候以控制员工接触粉尘或蒸汽。总体而言，作为控制员工暴露在粉尘或者蒸汽中的唯一手段，此办法恐怕不能满足需要。

装备推荐：

皮肤：加热或熔化过程中，有机会接触物料时应穿着长裤、长袖、隔热手套和面罩。

眼睛：推荐安全眼罩。

吸入：如果粉尘或分解气体的产生有可能高于所允许接触的上限值，推荐使用经国家职业安全与健康研究所认证的防毒面罩 / 口罩。

接触指导方针：本产品中可能含有的任何玻璃颗粒被聚合物系统紧密结合。残留的玻璃颗粒（<1%）可能存在，导致机械性的眼部、皮肤和呼吸刺激。包括机械加工或磨削在内的操作或部分应加以审查，以确保颗粒水平低于推荐的标准，本产品可能含有炭黑。见下列的接触极限值。

成分	机构	参数
炭黑	美国职业安全与健康条例 -允许接触极限 美国政府工业卫生专家会议 -临界值限定	3.5 mg/cu m 3.5 mg/cu m
微害惰性粉尘	美国职业安全与健康条例 -允许接触极限	15 mg/cu m (全部) 5 mg/cu m (可吸入)
微害颗粒/微粒	美国政府工业卫生专家会议 -临界值限定	10 mg/cu m (全部) 3 mg/cu m (可吸入)

第九部分：物理和化学特性

外观：颗粒状物
 气味：轻微的典型气味
 物理状态：固态
 气压：不适用
 熔点（树脂）： 265°C（509°F）
 溶解性：可忽略不计 <0.1%（水）
 比重： 1.40~1.50
 挥发率：<0.5按重量计

第十部分：稳定性和反应性

化学稳定性：在通常使用和储存条件下保持稳定
 避免条件：燃烧：不要加热超过 650°F（ 343°C）。避免长时间暴露在温度高于 600°F（316°C）的环境。
 不能共存性：强酸和氧化剂
 危险分解物：一氧化碳、氨 /氨水、脂族胺、氨基化合物/酰胺、酮、腈和氢氰酸。
 危险聚合反应：不会发生。

第十一部分：毒理学信息

本产品没有相关的具体资料。

第十二部分：生态学信息

生物毒性：对于树脂颗粒可能被野生动物摄入所造成的影响，我们还不是很清楚。如果是海鸟，一些海洋生物学家认为，鸟类消化道可能无法让塑料颗粒通过。因此，大量摄入颗粒可能会导致肠堵塞，饱食的错觉或营养吸收的减少，从而导致营养不良和饥饿。由塑料工业协会的发起的‘彻底清除行动’（OCS）的目标就是实现塑料颗粒零损失，防止其输入环境。
 环境结果/信息：此材料被认为是不可生物降解的。

第十三部分：处置条件

处置：鼓励回收。按照当地政策法规处置本产品。

第十四部分：运输信息

不适用

第十五部分：法规信息

<美国>《有毒物质管理法》：
 本产品的所有成分符合有毒物质管理法目录条例。
 <美国>《超级基金增补和再授权法案》： 本产品不包含任何受限于《紧急规划和社区知权法》（1986）第 313章和《联邦法规汇编》第 40标题第 372部分中的报告规定的有毒化学物质。

第十六部分：其它信息

危害等级：	健康	可燃性	反应性	其它
国家防火协会	1	1	0	
危险物质鉴别系统	1	1	0	

否认声明： 本产品不适用于作为医学或牙科植入物的使用。为获取详细的工艺指导和良好的生产实践（净化、工艺参数、停炉等），请参阅相应的大赛璐公告。据我们所知，这里所含的信息是正确的。我们没有暗示或者保证此文件所列出的危险已经包含全部危险。大赛璐不做任何关于在你方工艺或与其他物质结合过程中安全使用本产品的明示或暗示性的保证。本产品的使用效果可能会因为其他材料的使用而恶化；或者说本产品可能增强，也可能恶化其他材料的使用效果。用户有其责任对任何使用或者使用方式加以仔细考虑并确定物料的适用性。用户必须符合所有适用的安全和健康标准。

编号: LHES006		
MSDS		
1. 物品成分与厂商资料		
厂商名称: 浙江联和电子有限公司	物品编号: QSN6.5-0.1	
	物品名称: 磷铜端子	
	纯物质:	
	危害物质成分 (%) 无	
2. 成份辨识资料		
成份名称	化学文摘社登记号码(CAS No.)	浓度范围 (成分百分比 Percentage (%))
铜(Cu)	7440-50-8	余量
磷(P)	7723-14-0	0.0026-0.005%
锌(Zn)	7440-66-6	0.03-0.04%
镍(Ni)	7440-02-0	0.054-0.063%
锑(Sb)	7440-36-0	0.00015%
铅(Pb)	7439-92-1	<0.005%
铁(Fe)	7439-89-6	0.005-0.0059%
纯镍(Ni)	7440-02-0	0.054-0.063%
纯锡(Sn)	7440-31-5	6.2 %
2. 危害辨认资料		
严重危害效应	健康危害效应: 本产品 在固体时不具健康危害及危害	
	环境影响: 本产品 在固体时对环境不具影响	
	物理性及化学性危害: 固体/无味/多色	
	特殊危害: 固体时 (防火或高温) 无特殊危害	
主要症状: 无		
3. 急救措施		
急救方法	吸入: 无吸入	
	皮肤接触: 接触无危害	
	食入: 无食入	
主要症状及危害效应: 无		
4. 灭火措施		
通用灭火器: 二氧化碳, 泡沫, 干粉化学灭火器, 水雾等		
灭火时可能遭遇之特殊危害: 会引起火灾		
消防人员之特殊防护装备: 使用从氧式吸防护具		
5. 泄漏处理方法		
个人应注意事项: 注意工作台面清洁, 作业时及时清洗手		
环境注意事项: 将泄漏之物料以容器盛装以便回收或废弃		
清理方式: 工作台面每天作业前/后须擦拭干净, 建议可以戴手套或手指套作业		
6. 安全处置与储存方法		
处置: 废弃物可送到政府许可的废弃物处理中心进行处理		

储存: 空调仓, 23±5℃, 湿度 65%以下, 仓库里面安装灭火器	
7. 暴露预防措施	
个人防护设备	呼吸防护: 口罩, 一般无此要求, 可以建议采用
	手部防护设备: 手套火手指套, 一般无此要求, 可以建议采用
	眼睛防护: 安全目镜或眼镜
	皮肤及身体防护: 穿工作服, 经常勤洗
卫生措施: 建议使用安全目镜, 进食前应洗手及脸部, 平时多运动, 保持健康体力	
8. 材料及化学性质	
物质状态: 固体	形状: 连接器
颜色: 多色	气味: 无味
PH 值: 未测定	沸点: 未测定
分解温度: 未测定	爆炸介限: 无
自然温度: 固体无	溶解度: 固体无
9. 安全性及反应性	
安全性: 正常状态下安全	
特殊状况下可能之危害反应: 无	
应避免之状况: 避免接触火源和太阳光直照射	
应避免之物质: 火和酸碱性物质	
危害分解物: 无	
10. 毒性资料	
急毒性	吸入: 无
	皮肤接触: 无
	眼睛: 无
局部效应: 无	特殊效应: 无
11. 废弃物处理方法: 废弃物可送到政府许可的废弃物处理中心进行处理	
12. 运送资料	
联合国编号: 无	运输规定: 并无危险分类
运送方法及注意事项: 勿重压, 轻拿轻放	
13. 适用法规: 1.劳工安全卫生设施规划; 2.危害物及有害物通讯规划; 3.索尼环境通用规定; 4 劳工用业环境空气中有害物容许溶度标准; 5 道路交通安全规划	
14. 其他资料:	
15.法规资料	
适用法规	1.劳工安全卫生设施规则 2.RoHS 法规及有害物通识规则
16.其它资料	
参考文献	有害化学物质中文资料库, 环保局
制表单位	浙江联和电子有限公司
制造商及供应商地址	浙江省温州乐清市乐清湾港区创新路8号
电话	0577-62383699
制表者	季育文
制表日期	2022-3-23

编号：LHE-S006		
成品 MSDS		
1. 物品成分与厂商资料		
厂商名称：浙江联和电子有限公司	物品编号：LHE-WF1001	
	物品名称：黄铜镀锡针	
地址：浙江省温州乐清市乐清湾港区创新路8号	纯物质：	
联系电话：0577-62383699	危害物质成分（%）无	
2. 成份辨识资料		
成份名称	化学文摘社登记号码(CAS No.)	浓度范围（成分百分比 Percentage %）
铜(Cu)	7440-50-8	64.9%
磷(P)	7723-14-0	0.001%
锌(Zn)	7440-66-6	余量
镍(Ni)	7440-02-0	0.01%
锑(Sb)	7440-36-0	0.001%
铅(Pb)	7439-92-1	<0.009%
铁(Fe)	7439-89-6	<0.1%
纯镍(Ni)	7440-02-0	0.05%
纯锡(Sn)	7440-31-5	0.1%
2. 危害辨认资料		
严重危害效应	健康危害效应：本产品 在固体时不具健康危害及危害	
	环境影响：本产品 在固体时对环境不具影响	
	物理性及化学性危害：固体/无味/多色	
	特殊危害：固体时（防火或高温）无特殊危害	
主要症状：无		
3. 急救措施		
急救方法	吸入：无吸入	
	皮肤接触：接触无危害	
	食入：无食入	
主要症状及危害效应：无		
4. 灭火措施		
通用灭火器：二氧化碳，泡沫，干粉化学灭火器，水雾等		
灭火时可能遭遇之特殊危害：会引起火灾		
消防人员之特殊防护装备：使用从氧式吸防护具		
5. 泄漏处理方法		
个人应注意事项：注意工作台面清洁，作业时及时清洗手		
环境注意事项：将泄漏之物料以容器盛装以便回收或废弃		
清理方式：工作台面每天作业前/后须擦拭干净，建议可以戴手套或手指套作业		
6. 安全处置与储存方法		
处置：废弃物可送到政府许可的废弃物处理中心进行处理		

储存：空调仓，23±5℃，湿度 65%以下，仓库里面安装灭火器	
7. 暴露预防措施	
个人防护设备	呼吸防护：口罩，一般无此要求，可以建议采用
	手部防护设备：手套火手指套，一般无此要求，可以建议采用
	眼睛防护：安全目镜或眼镜
	皮肤及身体防护：穿工作服，经常勤洗
卫生措施：建议使用安全目镜，进食前应洗手及脸部，平时多运动，保持健康体力	
8. 物料及化学性质	
物质状态：固体	形状：连接器
颜色：多色	气味：无味
PH 值：未测定	沸点：未测定
分解温度：未测定	爆炸介限：无
自然温度：固体无	溶解度：固体无
9. 安全性及反应性	
安全性：正常状态下安全	
特殊状况下可能之危害反应：无	
应避免之状况：避免接触火源和太阳光直照射	
应避免之物质：火和酸碱物质	
危害分解物：无	
10. 毒性资料	
急毒性	吸入：无
	皮肤接触：无
	眼睛：无
局部效应：无	特殊效应：无
11. 废弃物处理方法：废弃物可送到政府许可的废弃物处理中心进行处理	
12. 运送资料	
联合国编号：无	运输规定：并无危险分类
运送方法及注意事项：勿重压，轻拿轻放	
13. 适用法规：1.劳工安全卫生设施规划；2.危害物及有害物通讯规划；3.索尼环境通用规定；4 劳工工业环境空气中有害物容许溶度标准；5 道路交通安全规划	
14. 其他资料：	
15.法规资料	
适用法规	1.劳工安全卫生设施规则 2.RoHS 法规及有害物通识规则
16.其它资料	
参考文献	有害化学物质中文资料库，环保局
制表单位	浙江联和电子有限公司
制造商及供应商地址	浙江省温州市乐清市乐清湾港区创新路8号
电话	0577-62383699
制表者	陈浙海
制表日期	2022-3-23

SAFETY DATA SHEET (SDS)

Issued: December 3, 2015

Revised: March 9, 2016

FileNo. 4052-1

1. Chemical Product & Company Identification

CHEMICAL PRODUCT NAME: LAPEROS® E130i VF2201
 NAME OF COMPANY: Polyplastics Co., Ltd.
 ADDRESS: 2-18-1 Konan, Minato-ku, Tokyo, 108-8280 Japan
 SECTION IN CHARGE: Quality Assurance Dept.
 TELEPHONE NUMBER: 03-6711-8605
 FACSIMILE NUMBER: 03-6711-8616

2. Hazards identification

[GHS CLASSIFICATION]

Physical and Chemical Hazards : ·Flammable solids : Classification not possible
 ·Self-reactive substances and mixtures : Not applicable
 ·Pyrophoric solids : Not classified
 ·Self-heating substances and mixtures : Not classified
 ·Substances and mixtures, which in contact with water, emit flammable gases : Not classified
 ·Oxidizing solids : Not classified
 ·Corrosive to metal : Not classified

Health Hazards : ·Carcinogeneses : No hazard
 ·Specific target organ/systemic toxicity (Repeated exposure) : No hazard

[GHS CLASSIFICATION]

Environmental Hazards : No hazard

[SYMBOL]

: None

[SIGNAL WORD]

: None

[HAZARD STATEMENT]

: None

[PRECAUTIONARY STATEMENTS]

Prevention : ·Wash hands thoroughly after handling.

·Wear protective gloves.

Response : -

Storage : Avoid direct sunlight and store in a well-ventilated place.

Disposal : Dispose of contents/container in accordance with local & national regulations.

3. Composition/information on ingredients

SUBSTANCE/PREPARATION : Preparation
 COMMON CHEMICAL NAME : Aromatic Liquid Crystal Polymer
 SYNONYMS : Aromatic Liquid Crystal Polymer(LCP)
 INGREDIENTS AND COMPOSITION : LCP ≥ 69%, Glass fiber 30%, Others ≤ 1%
 CHEMICAL FORMULA : not open
 SERIAL No. IN OFFICIAL GAZETTE : 7-2577(base resin) (Law Concerning Examination and Regulation of Manufacture, etc. , of Chemical Substances)
 CAS No. : 147310-94-9(base resin)
 INGREDIENTS CONTRIBUTING TO THE HAZARD : Cadmium, lead, hexavalent chromium and mercury are not used in this grade.

4. First-aid measures

INGESTION : When a gas generated from the molten polymer has been inhaled, move to area of fresh air without delay and wait until the victim is recovered. If sick feeling continues, ask a physician for advice.

SKIN CONTACT : Cool the contacted skin with clean water without delay, if a contact with the polymer in a molten form. Do not force to remove the solid resin on the skin. If any burns are observed on

EYE CONTACT	: the skin, ask a physician for advice. : Cool and rinse the eye with clean water for at least 15 minutes when the eyes had contact with molten polymer. In case of wearing contact lenses, remove the lenses as soon as possible, and ask a physician for advice. When the eye had contact with the polymer in an ordinary solid form, rinse the eye with clean water without delay. If the discomfort persists, ask a physician for advice.
SWALLOW	: Help to vomit as much as possible. If sick feeling continues, and ask a physician for advice.
<hr/>	
5. Fire-fighting measures	
EXTINGUISHING MEDIA	: Water, foam fire-extinguishing agent, powder fire-extinguishing agent, and carbon dioxide gas.
SPECIFIC METHODS	: Extinguish the fire with water. A method of extinguishing an ordinary fire may be applied. Do not apply water directly to processing machines.
SPECIFIC HAZARDS	: Incomplete combustion leads to generation of toxic gases such as carbon monoxide or phenol, in addition to carbonic acid gas and water.
SPECIAL PROTECTIVE EQUIPMENT FOR FIREFIGHTERS	: In case the fire gained force, use a gas mask or other protective equipment.
<hr/>	
6. Accidental release measures	
PERSONAL PRECAUTIONS	: When pellets were spilled on the road or floor, wipe them off with a besom or cleaner not to cause slipping.
ENVIRONMENTAL PRECAUTION	: Handle the spillage in accordance with provisions given in the "Resin pellet spillage preventive manual", in order to prevent intakes by marine animals and birds.
<hr/>	
7. Handling and storage	
HANDLING	: LCP polymer in a pellet form will neither ignite nor explode at room temperatures.
HANDLING 2	: This pellets spilled on the floor are likely to cause slipping. Remove such spillage at any times.
HANDLING 3	: For molding work, effective means for local exhaust are required to discharge gases generated by melt processing.
HANDLING 4	: Avoid inhaling of gases generated in molding work. Do not directly touch resin of high temperature.
HANDLING 5	: Avoid retaining hot resin in the processing machines for many hours.
HANDLING 6	: Glass fibers are not generally exposed in a single substance under normal processing and handling conditions as they are compounded in pellets. However, the following measures will be necessary to minimize the exposure to glass fibers or dusts containing glass fibers, when pellets or molded parts containing glass fibers are cut, ground or burnt, depending on environmental and operational conditions. ·Those who are sensitive in skin to glass fiber should wear suitable(protective) clothes to minimize the exposure of their skin. ·Wash working clothes apart from other laundry, so that the latter will not cause contamination with glass fibers. ·Provide the workshop with partitions to prevent diffusion of glass fiber dusts. ·Pay precautions not to rub face, neck or arms with hands. Wash hands and gargle after working without fall. ·Keep dust sources totally enclosed.

	<ul style="list-style-type: none"> · Provide local air exhausters and implement periodical inspections and adjustments at least once a year. · Reduce cutting and grinding processes to the possible minimum, and devise working procedures to minimize dust generation. · Provide dust-preventive masks, protective glasses and gloves for personal hygiene. · Determine the operational environment at indoor working places and confirm the effects of environmental improvement.
STORAGE	: Keep the substance away from any fire or heat sources for the sake of safe storage.
STORAGE 2	: Handle in accordance with municipal rules and regulations.
RECOMMENDED PACKAGING MATERIALS	: No information.
<hr/>	
8. Exposure controls/ personal protection	
CONTROL CONCENTRATION	: None at present
PERMISSIBLE CONCENTRATION	: OSHA PEL/1985 Max. permissible concentration of inactive powder 15mg/m3 - ditto - (Aspiration) 5 mg/m3 ACGIH TLV/1992 1993 Exposure limit of the powder TWA 10 mg/m3
ENGINEERING MEASURE	: · When handling dust: Use totally enclosed containers resisting dust explosion. · When heat melted in molding: Effective local ventilation must be provided.
PERSONAL PROTECTIVE EQUIPMENT	
RESPIRATORY PROTECTION	: Wear a dust-proof mask.
HAND PROTECTION	: Wear heat-resisting gloves against burns, when handling molten polymer.
EYE PROTECTION	: Wear protective glasses or goggles.
SKIN & BODY PROTECTION	: Wear long sleeve clothes against burns, when handling molten polymer.
<hr/>	
9. Physical and chemical properties	
APPEARANCE etc.	: Pellet
BOILING POINT	: Not applicable
VAPOUR PRESSURE	: Not applicable
VOLATILITY	: Not applicable
INITIAL BOILING POINT	: Not applicable
SUBLIMATION	: None
MELTING POINT	: 335°C~345°C
DENSITY	: 1.61
SOLUBILITY	: Insoluble in water
FLASH POINT	: No finding
IGNITION POINT	: 540°C or higher
EXPLOSION PROPERTY	: Not applicable
INFLAMMABILITY	: It is flammable, but shows self-fire extinguishing characteristics when kept away from flame.
REACTIVITY WITH WATER	: None
OXIDIZABILITY	: None
SELF-REACTIVITY	: None
DUST EXPLOSIVENESS	: No finding
<hr/>	
10. Stability and reactivity	
STABILITY AND REACTIVITY	: Stable for normal storage or handling.

11. Toxicological information

SKIN CORROSION/IRRITATION	:	No finding.
SERIOUS EYE DAMAGE/IRRITATION	:	Gas generated in drying or melting is irritating eyes and skins.
RESPIRATORY OR SKIN SENSITISATION	:	No finding
ACUTE TOXICITY(INCLUDING LD50)	:	No finding.
SUBACUTE TOXICITY	:	No finding.
CHRONIC TOXICITY	:	No finding.
CARCINOGENECITY	:	No finding.
MUTAGENECITY(Micro organisms, chromosomal aberration)	:	No finding.
REPRODUCTIVE TOXICITY	:	No finding.
TERATOGENICITY	:	No finding.
OTHERS(Including generation of hazardous gases by reaction with water, for example)	:	No finding in this report means that there will be no hazard in general, but no proving data available at the time of reporting.
OTHER CAUTIONS	:	With regard to dust, the maximum permissible concentration and limits are fixed by OSHA and ACGIH.
OTHER CAUTIONS 2	:	Information on hazards of glass fibers as filler.

<Effects on Human Bodies>

(1) Effects on skin

Stimulation to the skin with glass fibers may be caused when glass fibers diameter is larger than $4.5\sim 5\mu\text{m}$. They give mechanical stimulation followed by itchiness to the skin, but further continuous exposure reportedly results in extinction of stimulation. It may sometimes leads to irritable dermatitis complicated with urticaria or eczema-like reaction. It is, however reported that such dermatitis is not so serious in general and does not last too long. Therefore, skin stimulation can be prevented by proper use of glass fibers.

(2) Effects on Tumor

Investigations made on glass fibers till today reveal that there is neither increase in mortality of glass fiber production workers due to lung cancer or mesothelioma nor such cases reported.

<Animal Test Report>

It is suggested that carcinogenicity of mineral fibers is dependent on their shapes rather than on their constituents. According to a report on experiments using 17 kinds of artificial mineral fibers in various sizes prepared by Dr.Stanton of National Cancer Institute, in USA, statistical studies on correlations between the diameter and length of fibers and the coincidence of mesothelioma have revealed that mineral fibers having a diameter smaller than $0.25\mu\text{m}$ and a length larger than $8\mu\text{m}$ are closely related to the coincidence of cancers. Since these experiments were performed by artificially dosing the subject animals with a large quantity of glass fibers and consequently they are quite different from the actual exposures to human bodies, it is told to be problematic to make a conclusion that mineral fibers are hazardous to human health, basing on the results obtained from these experiments. Up to the present time, there is no result obtainable to demonstrate a mechanism of glass fibers causing lung cancers in spite of experiment by long exposure to glass fibers with high concentration.

12. Ecological information	
BIODEGRADABILITY	: No finding.
BIOACCUMULATION	: No finding.
FISH TOXICITY	: No finding.
HAZARDS TO OZONE LAYER	: None
13. Disposal considerations	
WASTE FROM RESIDUES	: This is designated as waste plastics among industrial wastes by the Wastes Disposal Law. Disposal waste pellets through licensed wastes handlers or local autonomous bodies if they are handling wastes disposal.
WASTE FROM RESIDUES 2	: When disposed by incineration, use the well controlled incinerators in accordance with the Wastes Disposal Law, Air Pollution Control Law and Water Pollution Prevention Law.
14. Transport information	
UN CLASSIFICATION NUMBER	: Not applicable
OTHER CAUTIONS	: Handle with care so as not to give damages to containers or not to be subjected to wetting.
OTHER CAUTIONS 2	: Secure the containers firmly so as not to cause collapsing.
15. Regulatory information	
WASTE DISPOSAL LAW	: Waste plastics among industrial wastes.
16. Other information	
HANDLING OF THE DETAILS GIVEN ABOVE	: This SDS is the English version translated from the Japanese SDS which is prepared for domestic use. Details given above are based on references, information and data available at this moment, but no warranty can be made on exactness of these details. They are also prepared on the assumption that the product will be handled in a normal way. For special handling, adequate safety and environmental measures should be taken in respect to its applications. Our products are not specifically intended for implants for medical and dental applications, and therefore they are not recommended for such applications. "No finding" in this report means that there will be no hazard in general, but no proving data is available at the time of reporting.
WHERE TO CALL FOR FURTHER INFORMATION	: Polyplastics Co., Ltd. Quality Assurance Dept. Tel. No 03-6711-8605

*LAPEROS® is a registered trademark of Polyplastics Co., Ltd. in Japan and other countries.

