



**SCHROFF**

Project - 0 item(s)

**MY PROJECT LIST**

- PRODUCTS
- APPLICATIONS
- INDUSTRIES
- NEW PRODUCTS
- CONFIGURATORS
- Products ▾
- Search

Home > C-Rail (Eurorack)

## C-Rail (Eurorack)

**SCHROFF**

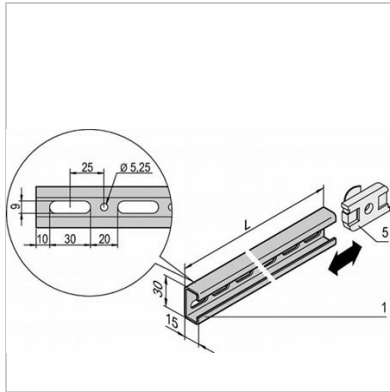

**Catalog Number: 22114-455**

[Back To Product](#)

- The mounting system provides for fitting of horizontal and vertical mounting planes
- By using slide nuts, C-profiles may be positioned steplessly
- Cable shells can be placed directly into the C-profiles.

**Product family:**

Eurorack

**Note:**

Please order brackets for assembly separately

**Accessory category:**

Cable management



Other Views

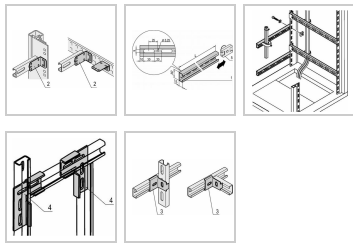

**Select product specifications before modifying or adding to project list or requesting a quote.**

Length-mm-defining

[Clear Selection](#)

Quantity

**Add Item to Project List +**

**Documents**

Main Catalog - Eurorack

### Technical Data

<b>Qty</b>	PU 1 kit
<b>For cabinet width mm</b>	600.0
<b>For cabinet depth mm</b>	600.0
<b>Description</b>	C-rails, 1 kit=4 units
<b>Length L mm</b>	450.0

### Delivery Comprises:

Item	Quantity	Description
1	4	C profile, St, 1.5 mm, Finish ALZn

### Accessories

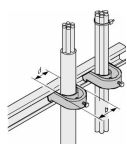

Cable shell , for cable bundle 42 ... 46 mm, PU 10 pieces

20114-731

**Add Item to Project List +**

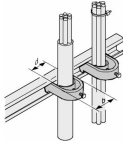

Cable shells , for cable bundle 38 ... 42 mm, PU 10 pieces

20114-730

[Add Item to Project List +](#)

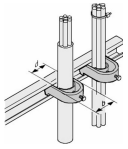

Cable shells , for cable bundle 34 ... 38 mm, PU 10 pieces

20114-729

[Add Item to Project List +](#)

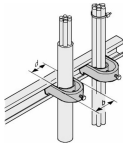

Cable shells , for cable bundle 30 ... 34 mm, PU 10 pieces

20114-728

[Add Item to Project List +](#)

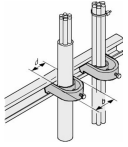

Cable shells , for cable bundle 26 ... 30 mm, PU 10 pieces

20118-777

[Add Item to Project List +](#)

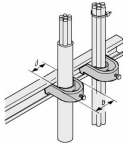

Cable shells , for cable bundle 22 ... 26 mm, PU 10 pieces

20118-776

[Add Item to Project List +](#)

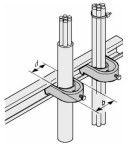

Cable shells , for cable bundle 18 ... 22 mm, PU 10 pieces

20118-775

[Add Item to Project List +](#)

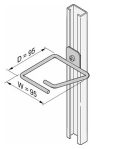

Cable eye for C-profile, Perforation: 95 x 95 mm

20118-340

[Add Item to Project List +](#)

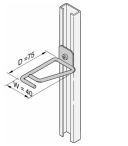

Cable eye for C-profile, Lochmaße: 75 X 40 mm

20118-554

[Add Item to Project List +](#)

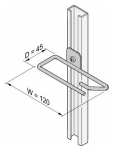

Cable eye for C-profile, Perforation: 45 x 120 mm

20118-339

[Add Item to Project List +](#)

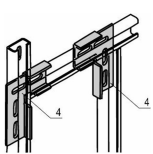

L-bracket, for edge-to-edge or corner connection of two C-profiles, St, 2.5 mm, zinc-plated, 2 right hand brackets and 2 left hand brackets, incl. assembly kit

21120-147

[Add Item to Project List +](#)

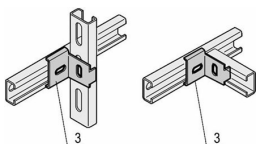

Combination bracket, for connection of two C-profiles, St, 2.5 mm, zinc-plated, PU 4 pieces, incl. assembly kit

21120-146

[Add Item to Project List +](#)

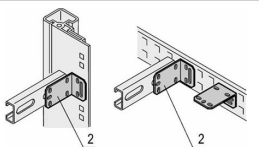

Mounting bracket, for cabinet upright or depth member installation, St, 2.5 mm, zinc-plated, PU 4 pieces, incl. fixing materials kit

21120-145

[Add Item to Project List +](#)

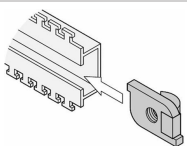

Slide nut for C-profiles, PU 100 pieces

21101-127

[Add Item to Project List +](#)

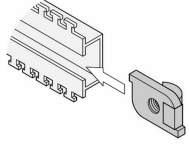

Slide nut for C-profiles, PU 10 pieces

21120-140

[Add Item to Project List +](#)

### EXPLORE

- [About Us](#)
- [Services & Capabilities](#)
- [News & Events](#)
- [Newsletter Subscriptions](#)
- [Strategic Partnerships](#)
- [Investor Relations](#)

### CONTACT

- [Customer Service](#)
- [Find a Sales Office or Distributor](#)
- [Global Locations](#)
- [Product Compliance & Certifications](#)
- [Partner Login](#)

### DOWNLOAD

- [Download Center](#)
- [Reference Projects](#)
- [Videos](#)
- [Product Configurators](#)
- [Warranties and Terms of Sale & Procurement](#)

© 2018 nVent. All rights reserved | [Privacy Policy](#) | [Terms of Use](#) | [Cookie Policy](#) | [Imprint](#) | [Site Map](#)

### Connect With Us

