

技术指标:

1. 温度范围:  $-25^{\circ}\text{C} \sim 85^{\circ}\text{C}$ .
2. 额定电流: 5.0A AC DC.
3. 额定电压: 250V AC DC.
4. 耐电压: 1000V AC/minute.
5. 接触电阻:  $\leq 20\text{m}\Omega$ .
6. 绝缘电阻:  $\geq 1000\text{M}\Omega$ .

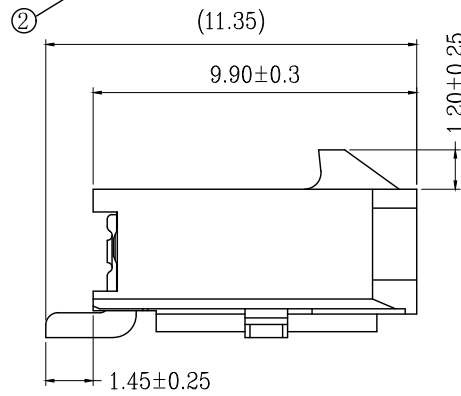

CKT	DIM A	DIM B
2	3.00	9.65
3	6.00	12.65
4	9.00	15.65
5	12.00	18.65
6	15.00	21.65
7	18.00	24.65
8	21.00	27.65
9	24.00	30.65
10	27.00	33.65
11	30.00	36.65
12	33.00	39.65

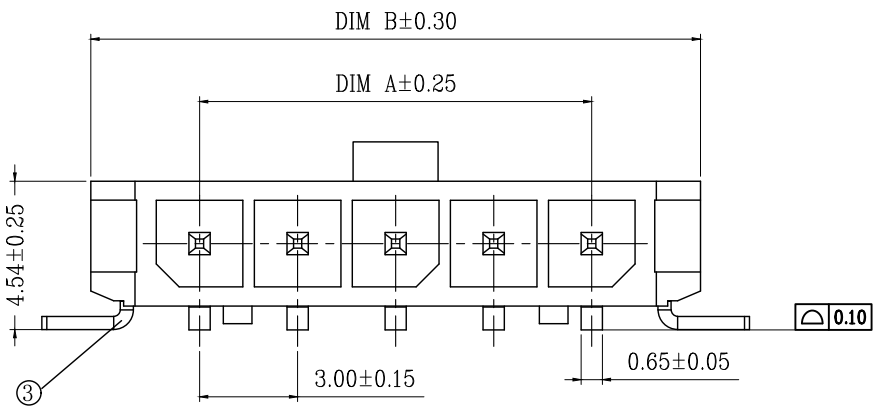
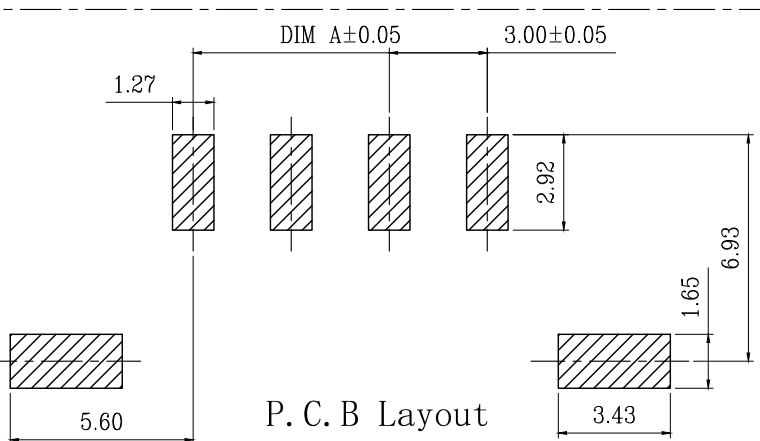

序号	品名	材质
①	MX3.0单排卧式胶芯	LCP UL94V-0 黑色
②	MX3.0单排卧式端子	铜合金/表面镀锡
③	MX3.0单排卧式焊片	铜合金/表面镀锡

 <b>深圳市万骏达电子有限公司</b> <a href="http://www.wanjunda.com">http://www.wanjunda.com</a>		图号 (DWG NO)	单位 (UNIT): MM
品名 (ITEM NO)		本 (REV)	比例 (SCALE) 1:1
料号 (PART NO)		日期 (DATE)	 未注公差 TOLERANCE UNSPECIFIED X.X ±0.30 X.XX ±0.15 X.XXX ±0.10 X" ±5° X.X" ±2°
模号 (MODEL NO)		设计 (DESIGN)	
		审核 (CHECKED)	
		核准 (APPROVED)	

P. C. B Layout

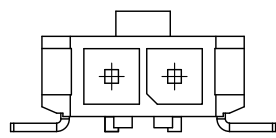

2PIN

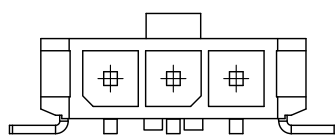

3PIN

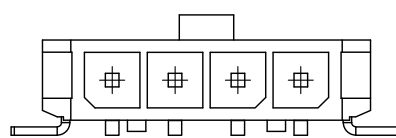

4PIN

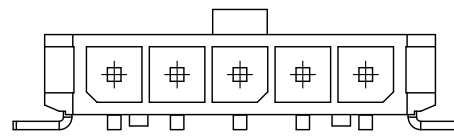

5PIN

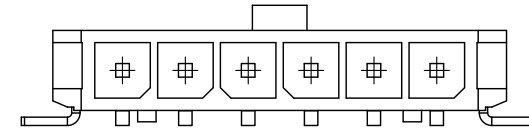

6PIN

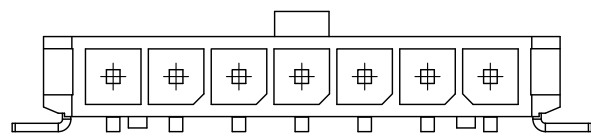

7PIN

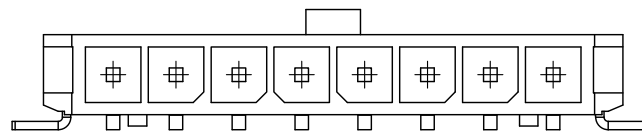

8PIN

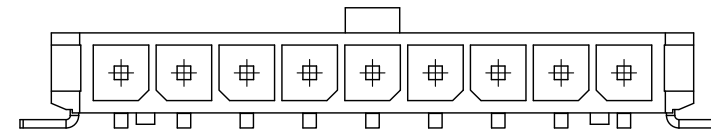

9PIN

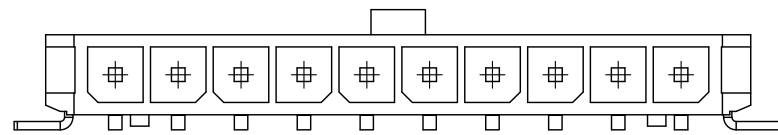

10PIN

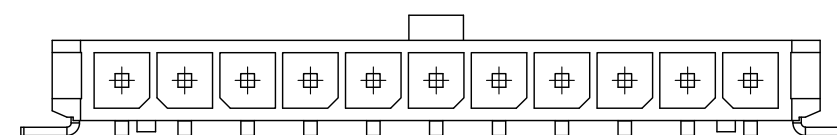

11PIN

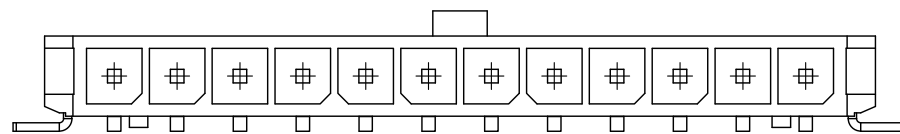

12PIN

 <b>深圳市万骏达电子有限公司</b> <a href="http://www.wanjunda.com">http://www.wanjunda.com</a>		图号 (DWG NO)		单位 (UNIT): MM
		本 (REV)		比例 (SCALE) 1:1
品名 (ITEM NO)	MX3.0单排卧式产品业务图	日期 (DATE)		 <b>未注公差</b> <small>TOLERANCE UNSPECIFIED</small> X.X ±0.30 X.XX ±0.15 X.XXX ±0.10 X" ±5° X.X" ±2°
料号 (PART NO)	WF-MX3.0-nP-WT	设计 (DESIGN)		
模号 (MODEL NO)		审核 (CHECKED)		
		核准 (APPROVED)		