

N-Channel Enhancement Mode Power MOSFET

Features

- $V_{DS} = 20V$, $I_D = 10A$
 $R_{DS(ON)} < 11\ m\Omega$ @ $V_{GS} = 4.5V$
 $R_{DS(ON)} < 14\ m\Omega$ @ $V_{GS} = 2.5V$

General Features

- Advanced Trench Technology
- Provide Excellent $R_{DS(ON)}$ and Low Gate Charge
- Lead Free and Green Available

100% UIS TESTED!
 100% ΔV_{ds} TESTED!

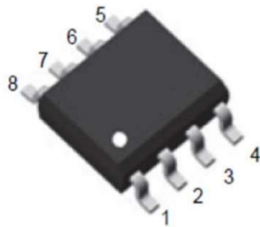

SOP-8

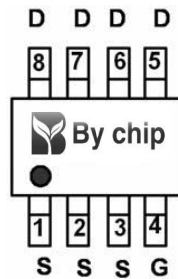

pin assignment

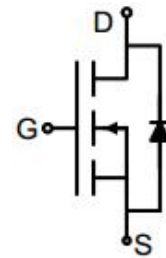

Schematic diagram

■ Absolute Maximum Ratings ($T_A = 25^\circ C$ unless otherwise noted)

Parameter		Symbol	Limit	Unit
Drain-source Voltage		V_{DS}	20	V
Gate-source Voltage		V_{GS}	± 10	V
Drain Current	$T_A = 25^\circ C$	I_D	10	A
	$T_A = 70^\circ C$		8	
Pulsed Drain Current ^A		I_{DM}	45	A
Total Power Dissipation	$T_A = 25^\circ C$	P_D	1.9	W
	$T_A = 70^\circ C$		1.2	
Thermal Resistance Junction-to-Ambient ^B		$R_{\theta JA}$	66	$^\circ C/W$
Junction and Storage Temperature Range		T_J, T_{STG}	-55 ~ +150	$^\circ C$

■ Electrical Characteristics ($T_J=25^{\circ}\text{C}$ unless otherwise noted)

Parameter	Symbol	Conditions	Min	Typ	Max	Units
Static Parameter						
Drain-Source Breakdown Voltage	BV_{DSS}	$V_{GS}=0V, I_D=250\mu A$	20			V
Zero Gate Voltage Drain Current	I_{DSS}	$V_{DS}=20V, V_{GS}=0V$			1	μA
Gate-Body Leakage Current	I_{GSS}	$V_{GS}=\pm 10V, V_{DS}=0V$			± 100	nA
Gate Threshold Voltage	$V_{GS(th)}$	$V_{DS}=V_{GS}, I_D=250\mu A$	0.5		2.0	V
Static Drain-Source On-Resistance	$R_{DS(on)}$	$V_{GS}=4.5V, I_D=10A$			11	m Ω
		$V_{GS}=2.5V, I_D=4A$			14	
		$V_{GS}=1.8V, I_D=2A$			18.2	
Diode Forward Voltage	V_{SD}	$I_S=10A, V_{GS}=0V$			1.2	V
Dynamic Parameters						
Input Capacitance	C_{iss}	$V_{DS}=10V, V_{GS}=0V, f=1\text{MHZ}$		888		pF
Output Capacitance	C_{oss}			133		
Reverse Transfer Capacitance	C_{rss}			117		
Switching Parameters						
Total Gate Charge	Q_g	$V_{GS}=4.5V, V_{DS}=10V, I_D=6.8A$		11.05		nC
Gate-Source Charge	Q_{gs}			1.73		
Gate-Drain Charge	Q_{gd}			3.1		
Turn-on Delay Time	$t_{D(on)}$	$V_{GS}=4.5V, V_{DS}=10V, I_D=6.8A$ $R_{GEN}=3\Omega$		7		ns
Turn-on Rise Time	t_r			46		
Turn-off Delay Time	$t_{D(off)}$			30		
Turn-off fall Time	t_f			52		

A. Pulse Test: Pulse Width $\leq 300\mu s$, Duty cycle $\leq 2\%$.

B. $R_{\theta JA}$ is the sum of the junction-to-case and case-to-ambient thermal resistance, where the case thermal reference is defined as the solder mounting surface of the drain pins. $R_{\theta JC}$ is guaranteed by design, while $R_{\theta JA}$ is determined by the board design. The maximum rating presented here is based on mounting on a 1 in 2 pad of 2oz copper.

■ Typical Performance Characteristics



Figure1. Output Characteristics

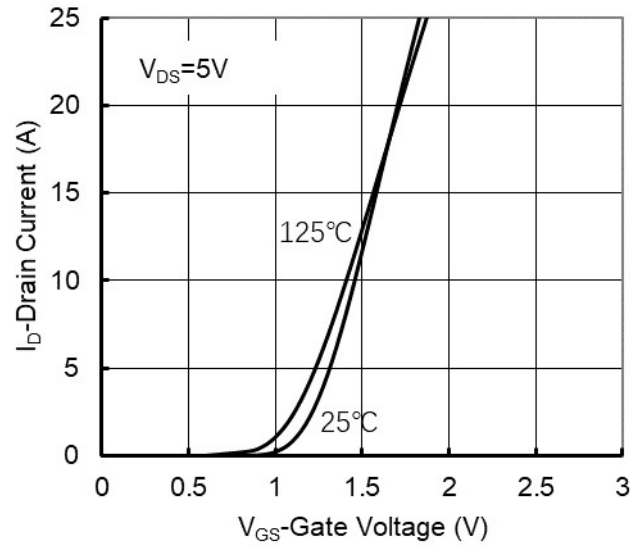

Figure2. Transfer Characteristics

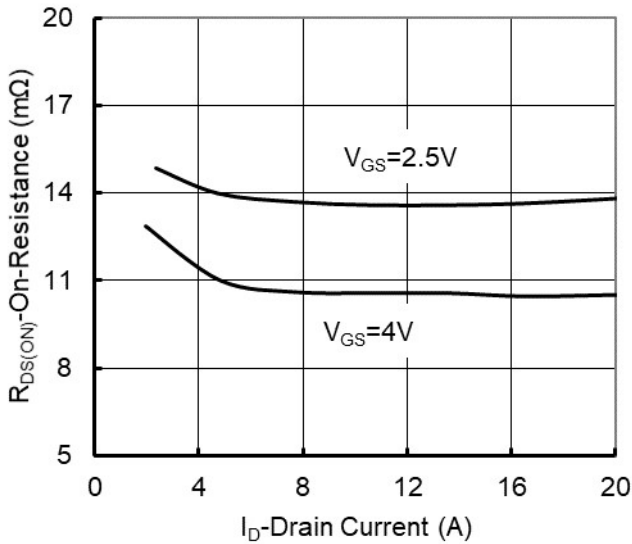

Figure 3: On-Resistance vs. Drain Current and Gate Voltage

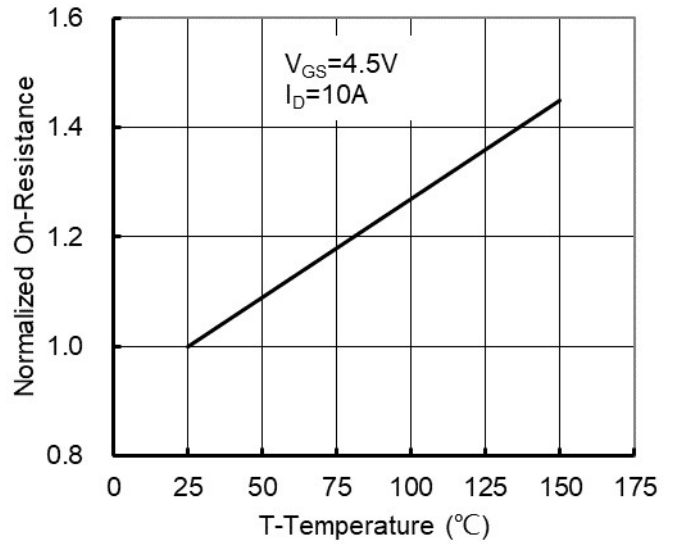

Figure 4: On-Resistance vs. Junction Temperature



Figure5. Capacitance Characteristics



Figure6. Gate Charge

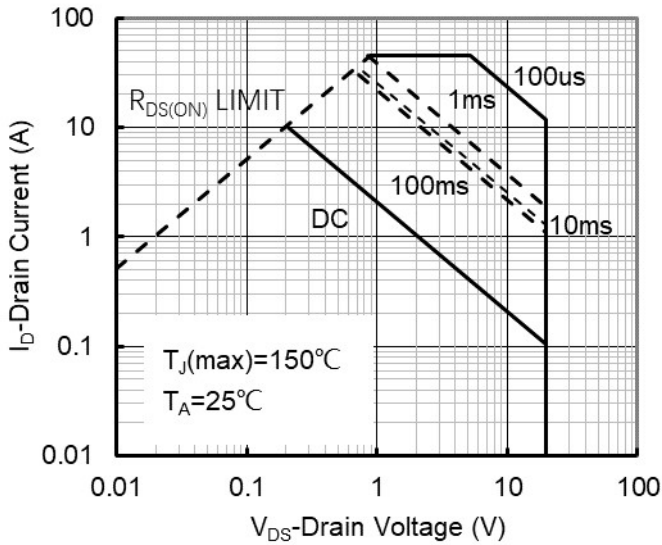

Figure7. Safe Operation Area

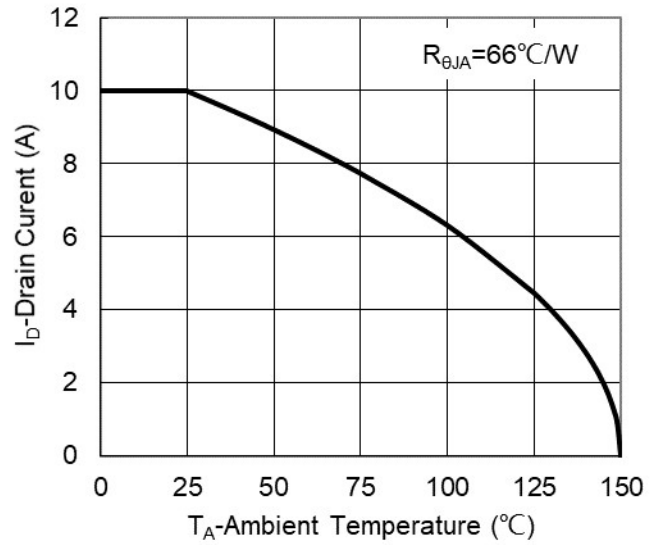

Figure8. Maximum Continuous Drain Current vs Ambient Temperature

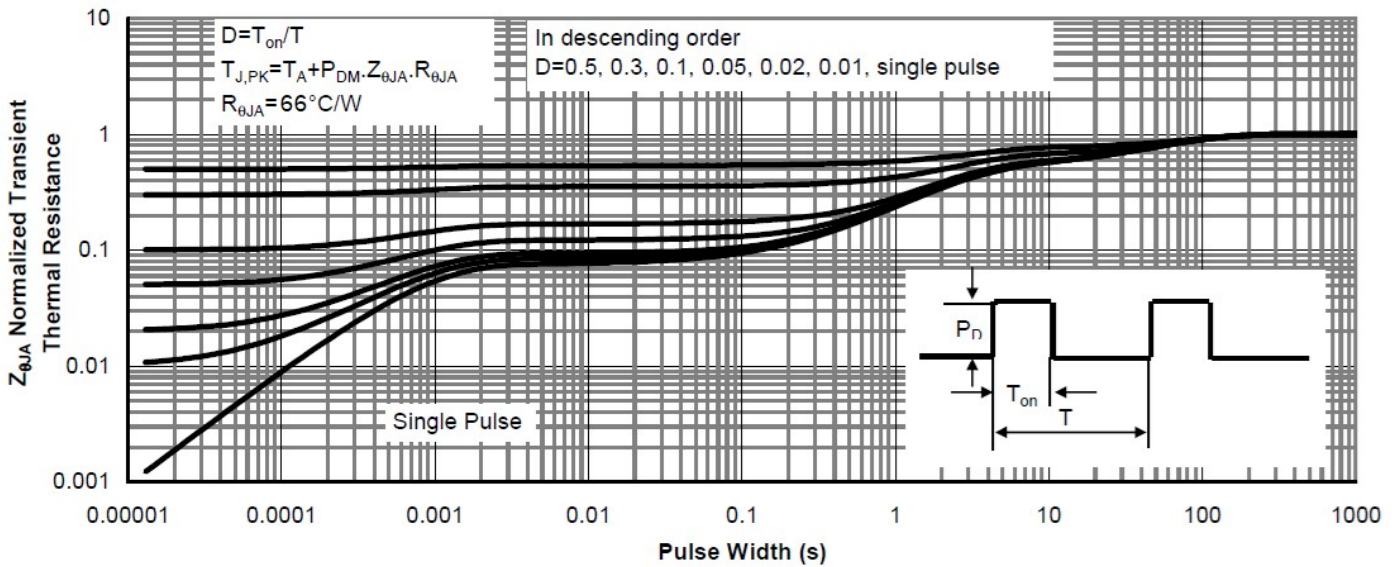
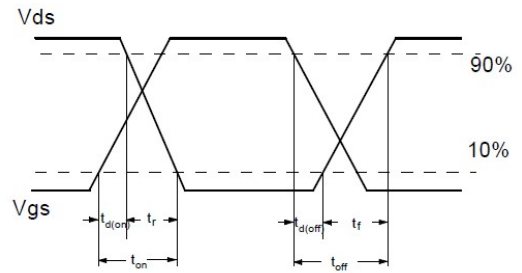
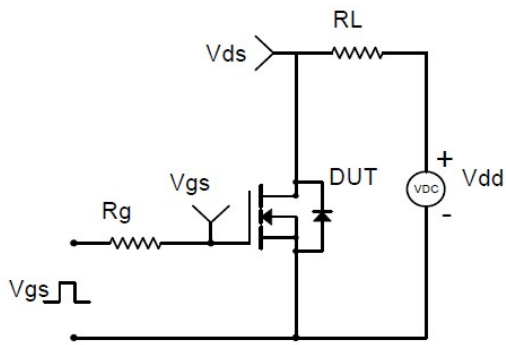
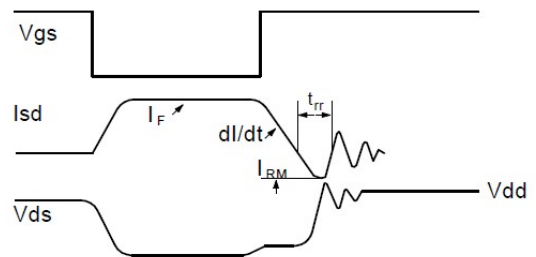
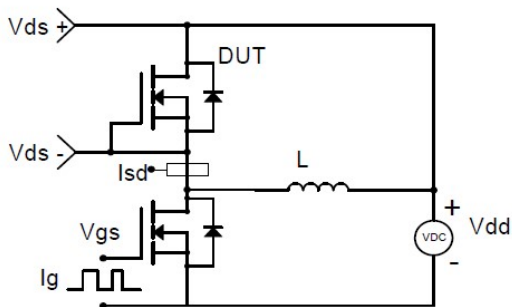

Figure9. Normalized Maximum Transient Thermal Impedance



Resistive Switching Test Circuit & Waveforms



Diode Recovery Test Circuit & Waveforms

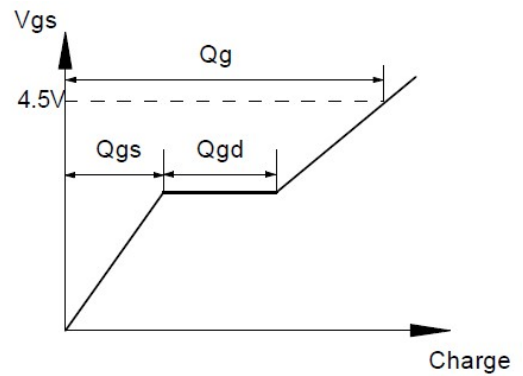

Gate Charge Test Circuit & Waveform

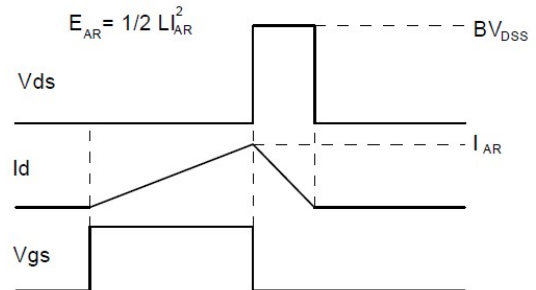
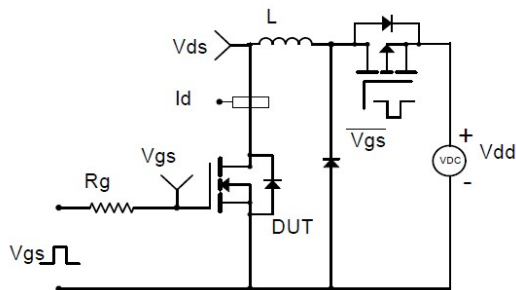

Unclamped Inductive Switching (UIS) Test Circuit & Waveforms