

HMD60N380E7

N-Channel MOS E7 Power MOSFET

600 V, 9.6 A, 380 mΩ

Description

The 600V MOS E7 is an advanced Power Master Semiconductor's Super Junction MOSFET family by utilizing charge balance technology for excellent low on-resistance and gate charge.

This technology combines the benefits of a fast switching performance with ease of usage and robustness.

Consequently, the MOS E7 family is suitable for application requiring high power density and superior efficiency.

Features

$BV_{DSS} @ T_{J,max}$	I_D	$R_{DS(on),max}$	$Q_{g,typ}$
650 V	9.6 A	380 mΩ	15.5 nC

- Reduced Switching & Conduction Losses
- Lower Gate Resistance
- 100% Avalanche Tested
- Pb free, Halogen Free, and RoHS Compliant

Applications

- PFC, Hard & Soft Switching Topologies
- Industrial & Consumer Power Supplies

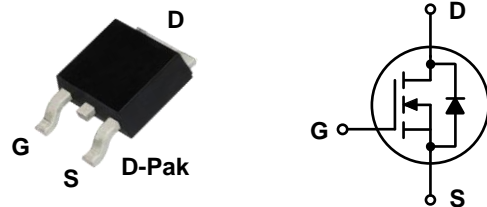

Absolute Maximum Ratings ($T_C = 25^\circ\text{C}$ unless otherwise noted)

Symbol	Parameter	Value	Unit
V_{DSS}	Drain to Source Voltage	600	V
V_{GSS}	Gate to Source Voltage	± 30	V
I_D	Drain Current	Continuous ($T_C = 25^\circ\text{C}$)	9.6
		Continuous ($T_C = 100^\circ\text{C}$)	6.1
I_{DM}	Drain Current	Pulsed (Note1)	28.8
E_{AS}	Single Pulsed Avalanche Energy	(Note2)	40
I_{AS}	Avalanche Current	(Note2)	2.5
E_{AR}	Repetitive Avalanche Energy	(Note1)	0.87
dv/dt	MOSFET dv/dt	100	V/ns
	Peak Diode Recovery dv/dt	(Note3)	
P_D	Power Dissipation	($T_C = 25^\circ\text{C}$)	87
		Derate Above 25°C	0.7
T_J, T_{STG}	Operating and Storage Temperature Range	-55 to 150	$^\circ\text{C}$
T_L	Maximum Lead Temperature for Soldering, 1/8" from Case for 10 Seconds	260	$^\circ\text{C}$

Thermal Characteristics

Symbol	Parameter	Value	Unit
$R_{\theta JC}$	Thermal Resistance, Junction to Case, Max.	1.43	$^\circ\text{C/W}$
$R_{\theta JA}$	Thermal Resistance, Junction to Ambient, Max. *minimal footprint	62.5	

Package Marking and Ordering Information

Part Number	Top Marking	Package	Packing Method	Reel Size	Tape Width	Quantity
HMD60N380E7	HMD60N380E7	D-Pak	Tape & Reel	330 mm	16 mm	2500 units

Electrical Characteristics ($T_C = 25^\circ\text{C}$ unless otherwise noted)

Symbol	Parameter	Test Conditions	Min	Typ	Max	Unit
--------	-----------	-----------------	-----	-----	-----	------

Off Characteristics

BV_{DSS}	Drain to Source Breakdown Voltage	$V_{GS} = 0\text{ V}, I_D = 1\text{ mA}$	600			V
		$V_{GS} = 0\text{ V}, I_D = 1\text{ mA}, T_J = 150^\circ\text{C}$	650			
I_{DSS}	Zero Gate Voltage Drain Current	$V_{DS} = 600\text{ V}, V_{GS} = 0\text{ V}$			1	μA
		$V_{DS} = 480\text{ V}, V_{GS} = 0\text{ V}, T_J = 125^\circ\text{C}$		2		
I_{GSS}	Gate-Source Leakage Current	$V_{GS} = \pm 30\text{ V}, V_{DS} = 0\text{ V}$			± 100	nA

On Characteristics

$V_{GS(th)}$	Gate Threshold Voltage	$V_{GS} = V_{DS}, I_D = 0.8\text{ mA}$	2.5		4.5	V
$R_{DS(on)}$	Static Drain to Source On Resistance	$V_{GS} = 10\text{ V}, I_D = 4.0\text{ A}$		318	380	m Ω

Dynamic Characteristics

C_{iss}	Input Capacitance	$V_{DS} = 400\text{ V}, V_{GS} = 0\text{ V},$ $f = 250\text{ kHz}$		628		pF
C_{oss}	Output Capacitance			20		pF
$C_{o(tr)}$	Time Related Output Capacitance	$V_{DS} = 0\text{ V to } 400\text{ V}, V_{GS} = 0\text{ V}$		239		pF
$C_{o(er)}$	Energy Related Output Capacitance			30		pF
$Q_{g(tot)}$	Total Gate Charge at 10 V	$V_{DS} = 400\text{ V}, I_D = 4.0\text{ A},$ $V_{GS} = 10\text{ V}$		15.5		nC
Q_{gs}	Gate to Source Charge			3.0		nC
Q_{gd}	Gate to Drain "Miller" Charge			7.9		nC
R_G	Gate Resistance	$f = 1\text{ MHz}$		1.0		Ω

Switching Characteristics

$t_{d(on)}$	Turn-On Delay Time	$V_{DS} = 400\text{ V}, I_D = 4.0\text{ A},$ $V_{GS} = 10\text{ V}, R_G = 10\ \Omega$ See Figure 13		8		ns
t_r	Turn-On Rise Time			7		ns
$t_{d(off)}$	Turn-Off Delay Time			30		ns
t_f	Turn-Off Fall Time			8		ns

Source-Drain Diode Characteristics

I_S	Maximum Continuous Diode Forward Current			9.6		A
I_{SM}	Maximum Pulsed Diode Forward Current			28.8		A
V_{SD}	Diode Forward Voltage	$V_{GS} = 0\text{ V}, I_{SD} = 4.0\text{ A}$			1.2	V
t_{rr}	Reverse Recovery Time	$V_{DD} = 400\text{ V}, I_{SD} = 4.0\text{ A},$ $di_F/dt = 100\text{ A}/\mu\text{s}$		221		ns
Q_{rr}	Reverse Recovery Charge			1.8		μC

※Notes:

1. Repetitive rating: pulse-width limited by maximum junction temperature.
2. $I_{AS} = 2.5\text{ A}, R_G = 25\ \Omega$, starting $T_J = 25^\circ\text{C}$.
3. $I_{SD} \leq 4\text{ A}, di/dt \leq 100\text{ A}/\mu\text{s}, V_{DD} \leq 400\text{ V}$, starting $T_J = 25^\circ\text{C}$.

Typical Performance Characteristics

Figure 1. On-Region Characteristics

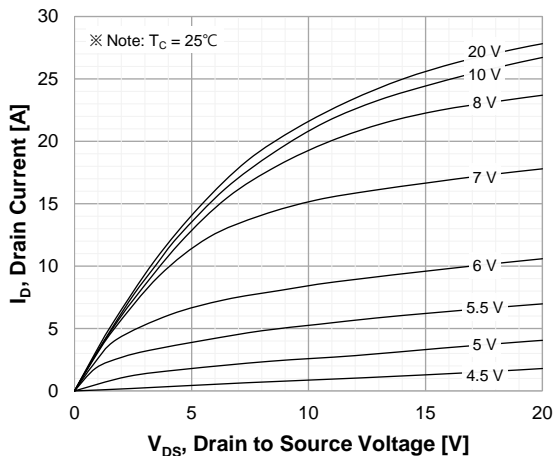

Figure 2. Transfer Characteristics

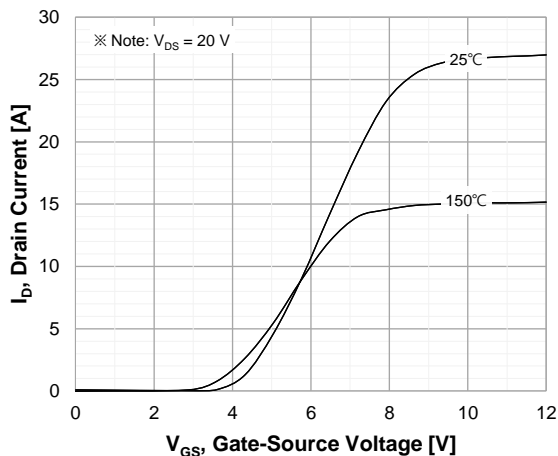

Figure 3. On-Resistance Characteristics vs. Drain Current and Gate Voltage

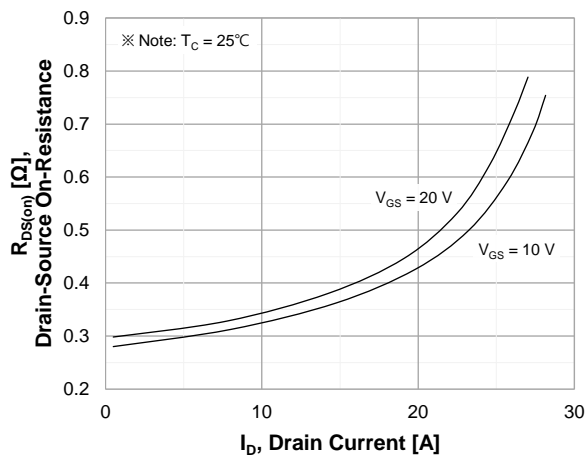

Figure 4. Diode Forward Voltage Characteristics vs. Source-Drain Current and Temperature

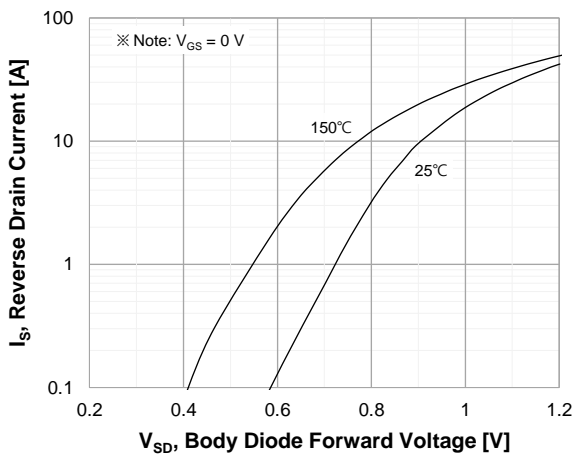

Figure 5. Capacitance Characteristics

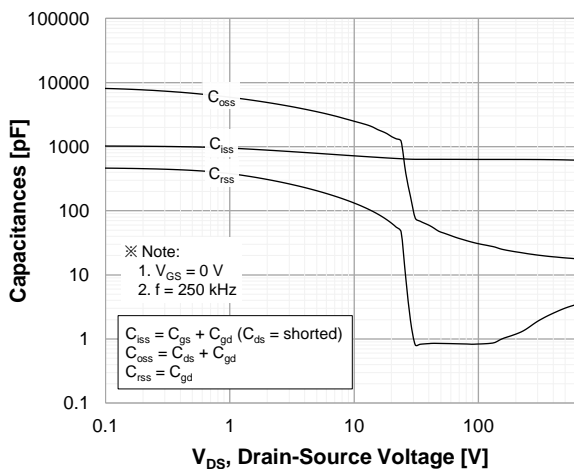
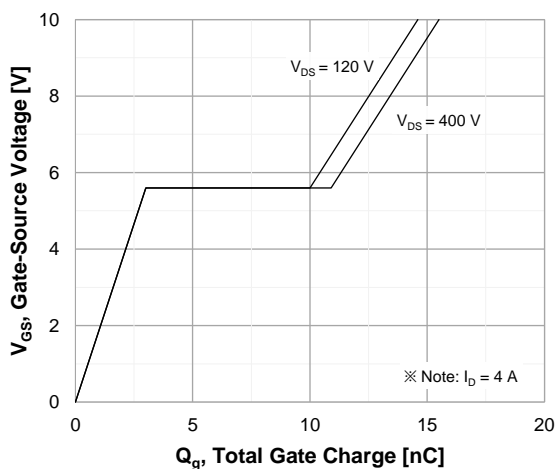

Figure 6. Gate Charge Characteristics



Typical Performance Characteristics

Figure 7. Breakdown Voltage Characteristics vs. Temperature

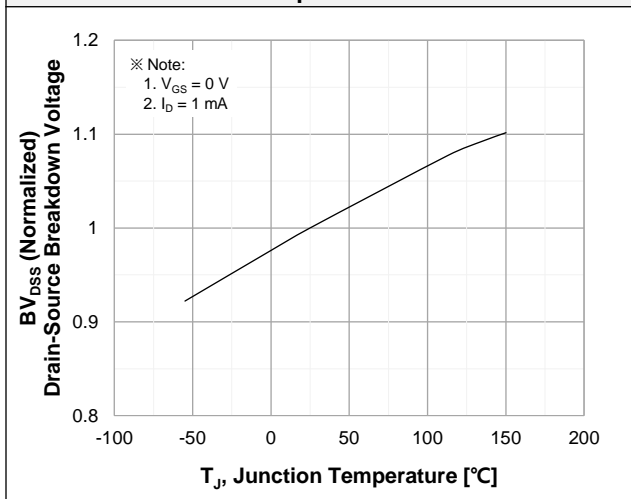

Figure 8. On-Resistance Characteristics vs. Temperature

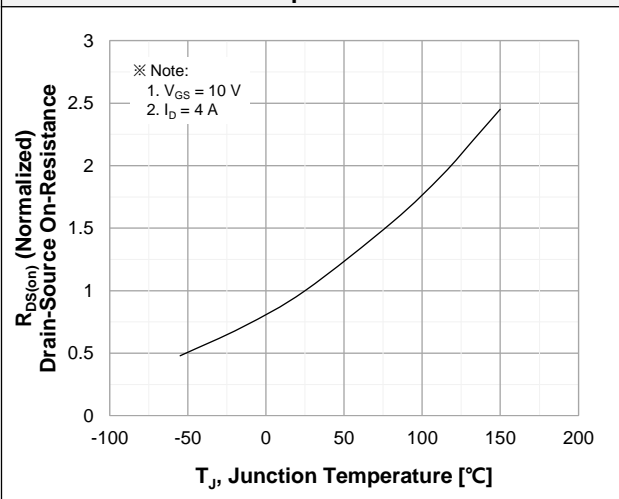

Figure 9. Maximum Safe Operating Area

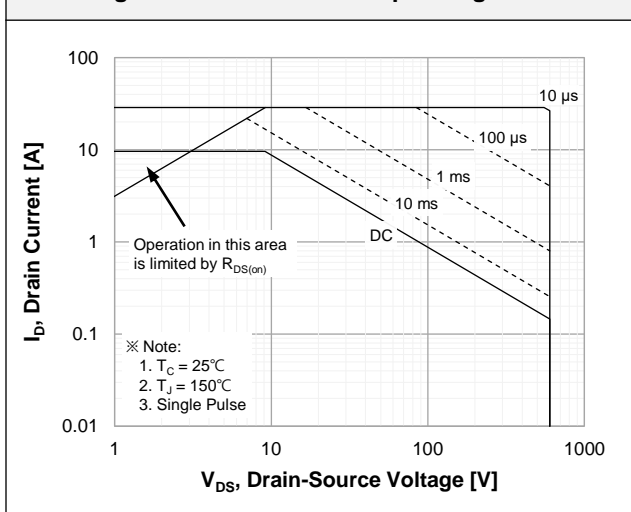

Figure 10. Maximum Drain Current vs. Case Temperature

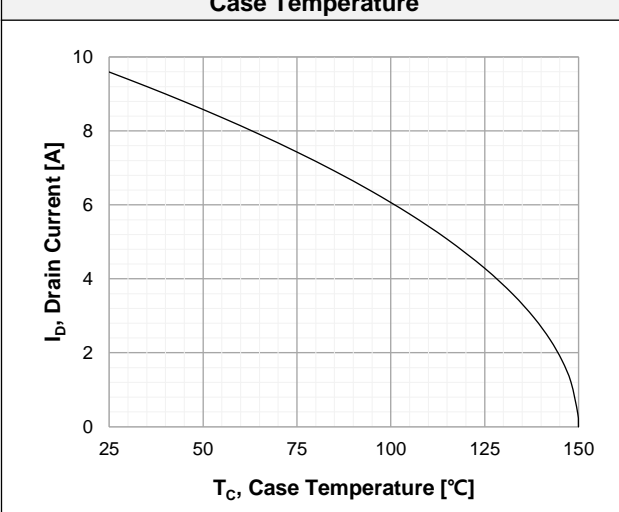

Figure 11. E_oss vs. Drain to Source Voltage

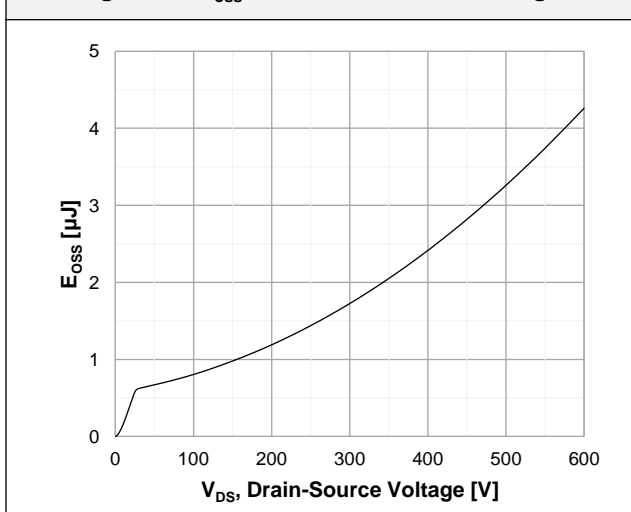
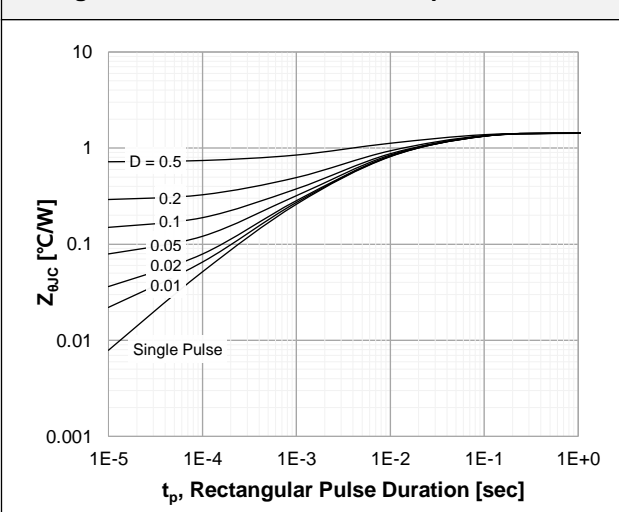

Figure 12. Transient Thermal Response Curve



Test Circuits

Figure 13. Inductive Load Switching Test Circuit and Waveforms

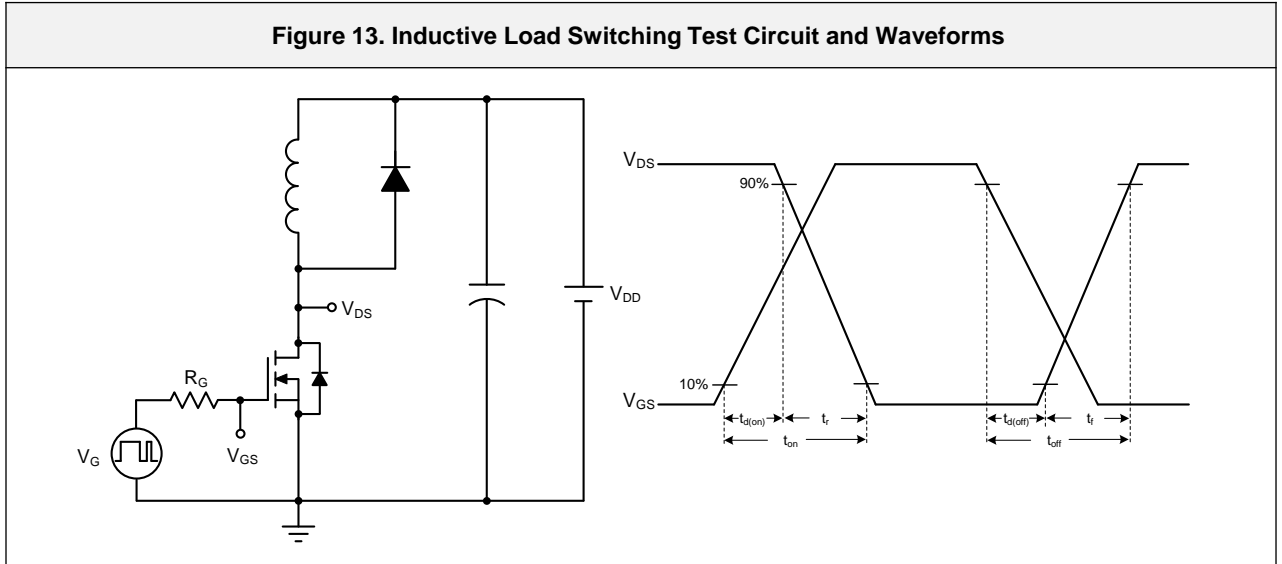

Figure 14. Unclamped Inductive Switching Test Circuit and Waveforms

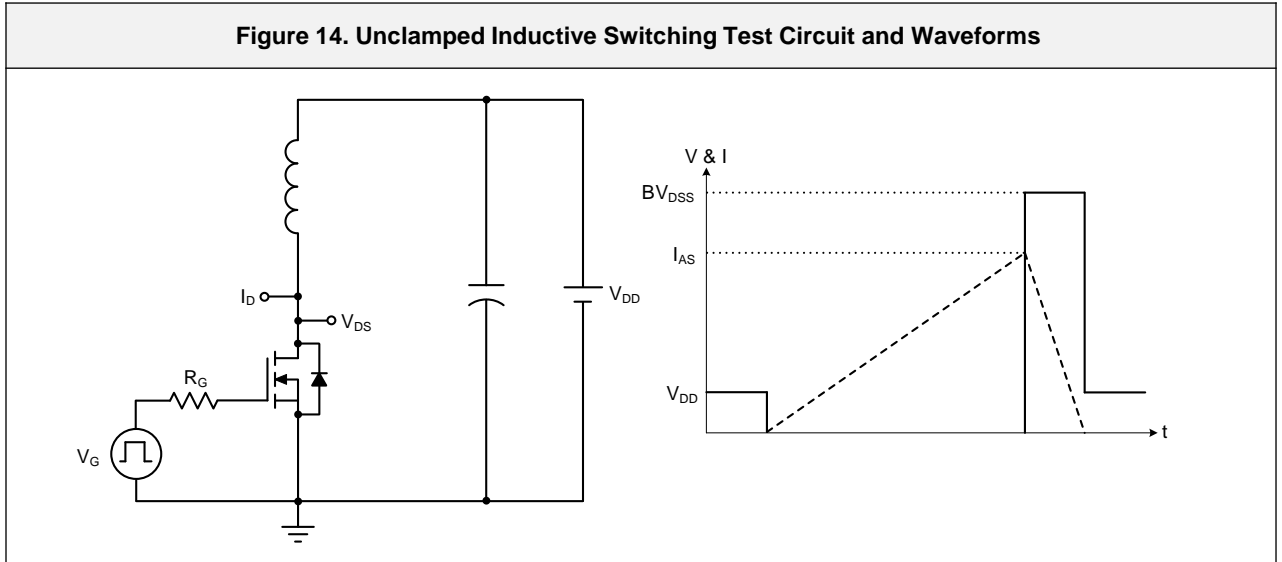
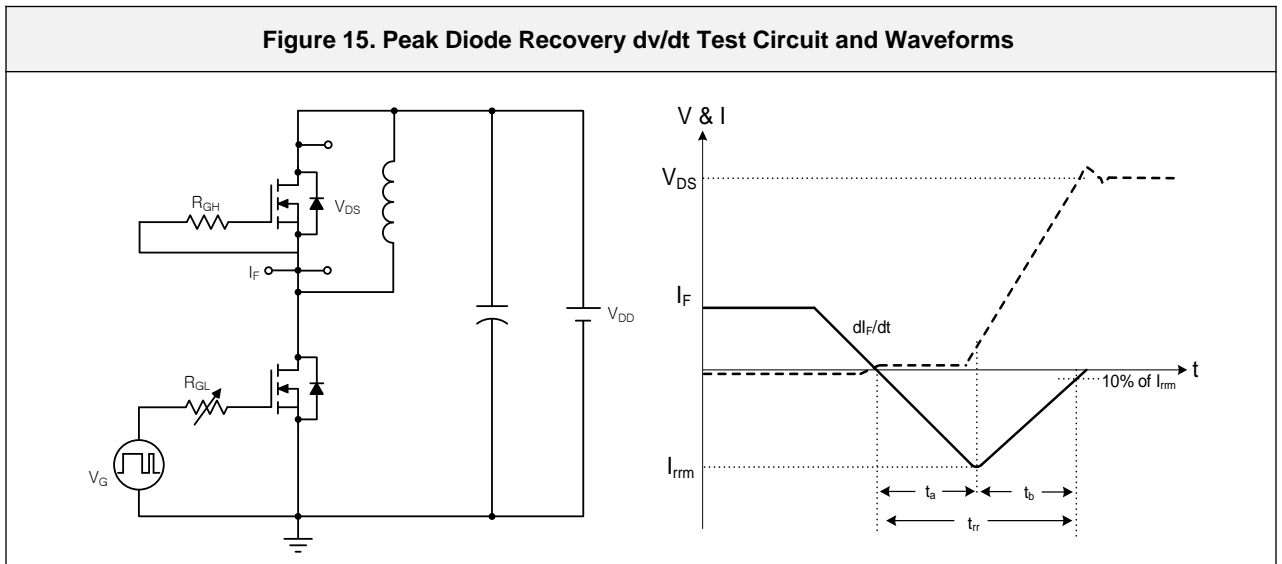
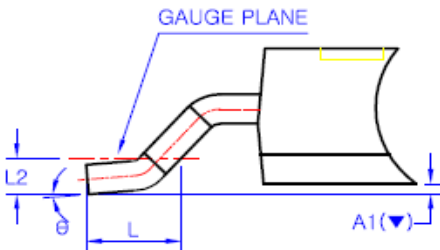
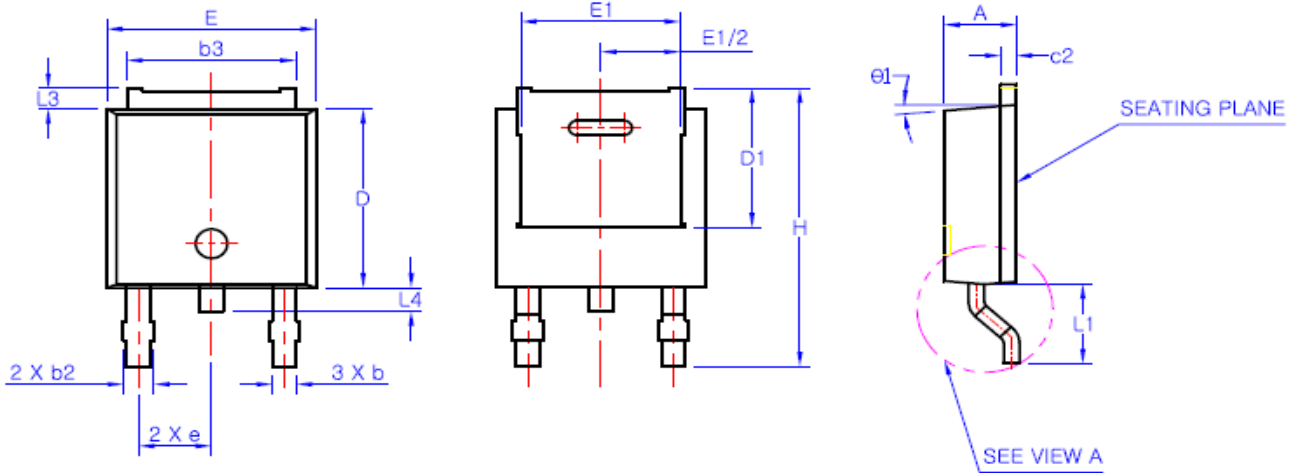

Figure 15. Peak Diode Recovery dv/dt Test Circuit and Waveforms



Package Outlines

D-Pak



VIEW A
OPTIONAL TIP LEADFORM
ROTATED 90° CW

SYMBOL	MIN	NOM	MAX
A	2.20	2.30	2.40
A1 (▼)	0.00	-	0.127
b	0.66	0.76	0.86
b2	-	-	0.96
b3	5.04	5.34	5.64
c2	0.40	0.50	0.60
D	5.90	6.10	6.30
D1	(4.75)		
E	6.40	6.60	6.80
E1	(5.04)		
e	2.30 BSC		
H	9.20	9.50	9.80
L	1.27	1.47	1.67
L1	2.50	2.70	2.90
L2	0.508 BSC		
L3	0.50	0.70	0.90
L4	0.60	0.80	1.00
θ	0°	-	10°
θ1	(5°)		

* Dimensions in millimeters