

Surface Mount Series 768



Medium Body, Small Outline Products

- Low profile—board to network clearance of 0.005"/0.010"
- Conforms to EIA PDP-100 SOGN-0002
- 24mm tape & reel or slide
- Application specific circuits are available
- No internal dendrite growth
- Compatible with all solder processes
Wave, IR reflow, Vapor phase reflow
- Recommended for bottom side attachment

Resistance Range:

Standard: 10Ω to 1 MegΩ

Resistance Tolerance:

Standard: ±2% or 0.5Ω (whichever is greater)
Special: ±0.25% or 0.3Ω (whichever is greater)

Maximum Operating Voltage:

50V not to exceed rated power

Temperature Coefficient:

Standard: 100Ω to 1 MegΩ
±100PPM/°C typical
10Ω to 99Ω
±200 PPM/°C typical

Operating Temperature Range:

-55°C to +125°C

Dielectric Strength:

100 VAC

Power Rating (Total Network Power):

	14 Pin	16 Pin	20 Pin
@25°C	2.0w	2.3w	3.0w
@70°C	1.3 w	1.5w	2.0w

Maximum Resistor Power:

(not to exceed total network power)

Schematic	1	3	5	7
@25°C	0.15w	0.3w	0.15w	0.15w
@70°C	0.1w	0.2w	0.1w	0.1w

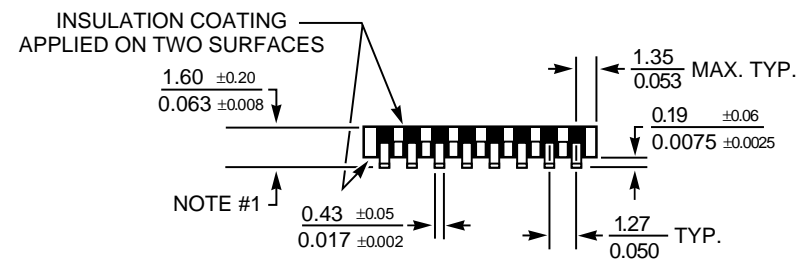
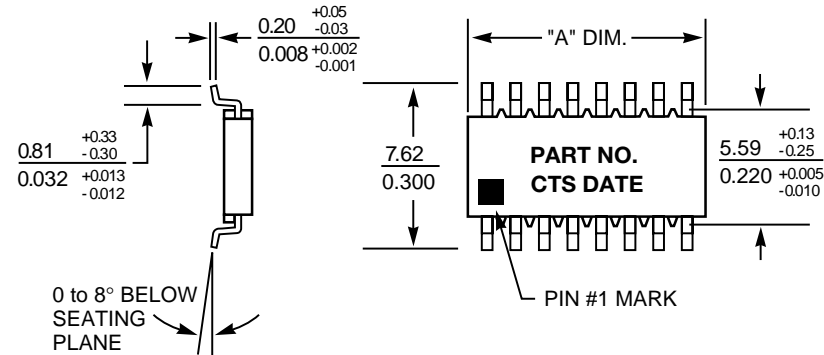

No. of Pins	"A" Dimension
14	9.91 + 0.25 / - 0.13
	0.390 + 0.010 / - 0.005
16	11.18 + 0.25 / - 0.13
	0.440 + 0.010 / - 0.005
20	13.70 + 0.25 / - 0.13
	0.540 + 0.010 / - 0.005

Notes:

- 1 Lead COPLANARITY 0.10 MAX. 0.004
- 2 mm & inch DIMENSIONS ARE NOT EQUIVALENT
- 3 General Tolerances mm ±0.25 inch ±0.010
- 4 Dimensions are mm/in.

Application Notes	pages 24-25
Power Derating	page 33
Land Patterns	pages 34-35
Packaging	pages 36-37
Environmental Performance Specifications	pages 38-39

Bussed CTS Schematic 1

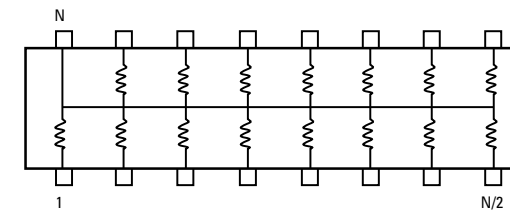

Isolated CTS Schematic 3

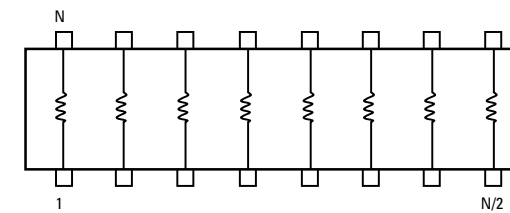

Dual Terminator CTS Schematic 5

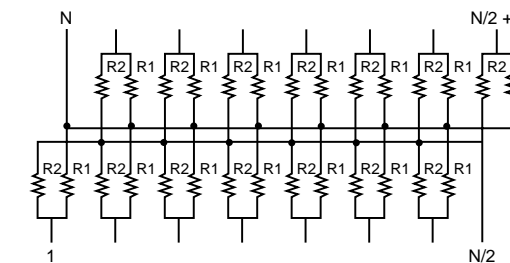

R/2R Ladder CTS Schematic 7

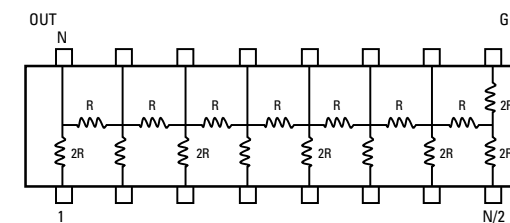

(Ohms)	EIA Code	(Ohms)	EIA Code
0 *	000X	3300	332
10	100	3900	392
12	120	4700	472
15	150	5100	512
18	180	5600	562
22	220	6800	682
27	270	8200	822
33	330	10000	103
39	390	11000	113
47	470	12000	123
51	510	15000	153
56	560	18000	183
68	680	20000	203
82	820	22000	223
100	101	27000	273
110	111	33000	333
120	121	39000	393
150	151	47000	473
180	181	56000	563
200	201	68000	683
220	221	82000	823
270	271	100000	104
330	331	110000	114
390	391	120000	124
470	471	150000	154
510	511	180000	184
560	561	200000	204
680	681	220000	224
820	821	270000	274
1000	102	330000	334
1100	112	390000	394
1200	122	470000	474
1500	152	560000	564
1800	182	680000	684
2000	202	820000	824
2200	222	1000000	105
2700	272		

*3Ω max

How to Order Series 768 Products

Application specific custom products are marked with either a customer part number or a non-descriptive CTS part number. Send documentation to a CTS Sales Office giving schematic, resistor values and tolerance, and other non-standard information. See pages 24-25 for application notes.

768 Series 768	14 Number of Pins 14 16 20	3 Schematic 1 Bussed 3 Isolated 5 Dual Terminator 7 Ladder	101 Resistor Code See Page 32 Schematic 5	G Tolerance Schematic 1 & 3 J= ±5% G= ±2% F= ±1% D= ±1/2%	TR Packaging - TR - Tape & Reel SP - Slide Pack (see page 36)
--------------------------	---	--	---	--	--

NOTE: No dashes or spaces to appear in part number.

Example: 768143101GTR

See page 33 for part marking information.

Dual Terminator

CTS Dual Terminator Schematics

Standard CTS Dual Terminator products contain (2N-2) resistors of two different values with each resistor value connected to a common buss. CTS assigns the resistance value portion of the standard part numbers of the dual terminator network in two different methods.

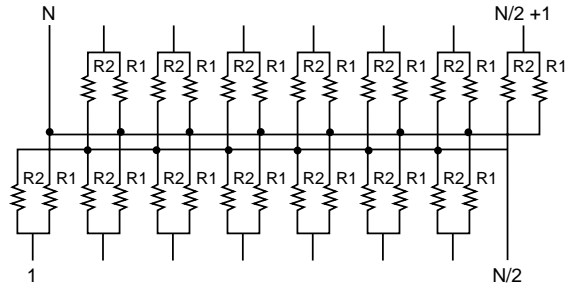

The Series 770 part number includes the actual values of the resistors in the dual terminator. For example:

770105180/470 R1=180Ω R2=470Ω

The Series 752, 766, 767 and 768 part number includes the EIA Code value of the Thevenin equivalent resistances of R1 and R2. The Thevenin equivalent resistance is calculated in the following way: the suffix letter relates only to the sequence of variations which equal the same equivalent resistance. Reference chart.

$$R_{eq} = \frac{R1R2}{R1 + R2}$$

Examples:

766165131A	R1=220Ω	R2=330Ω	Req=132Ω
767145191A	R1=330Ω	R2=470Ω	Req=194Ω
768205131C	R1=180Ω	R2=470Ω	Req=130Ω

Pin N/2 is common to R2 and Pin #N is common to R1 on CTS Series 766, 767 and 768.

Pin #1 is common to R2 and Pin N is common to R1 on all CTS Series 752, 753 and 770 dual terminator schematics.

1. All tolerances ±2%.
2. Other values available on request.
3. Suffix letter has no significance—assigned in sequential order.

Dual Terminator Resistor Values & Codes

R1 Ohms	R2 Ohms	Thevenin Equivalent	CTS Code	R1 Ohms	R2 Ohms	Thevenin Equivalent	CTS Code
25	50	15 ohm	150A	270	180	108 ohm	111C
30	50	19 ohm	190A	271	131	88 ohm	880A
30	620	29 ohm	290A	330	470	194 ohm	191A
33	4.7K	33 ohm	330A	330	680	222 ohm	221A
36	620	34 ohm	340A	330	390	179 ohm	181A
43	620	40 ohm	400A	330	220	132 ohm	131D
68	189	50 ohm	500B	330	330	165 ohm	171B
75	620	67 ohm	670A	360	720	240 ohm	241B
80	220	59 ohm	590A	360	600	225 ohm	231A
81	130	50 ohm	500A	390	620	239 ohm	241A
81	2.2K	78 ohm	780A	470	1K	320 ohm	321A
100	200	67 ohm	670B	470	680	278 ohm	281A
100	430	81 ohm	810A	470	940	313 ohm	311A
100	150	60 ohm	600A	500	500	250 ohm	251A
106	169	65 ohm	650A	560	910	347 ohm	351A
110	220	73 ohm	730A	560	1K	359 ohm	361A
118	178	71 ohm	710A	680	1K	405 ohm	401A
120	200	75 ohm	750B	750	750	375 ohm	381A
120	180	72 ohm	720A	750	2.3K	566 ohm	571A
120	120	60 ohm	600B	1K	3.3K	767 ohm	771A
150	150	75 ohm	750A	1K	2K	667 ohm	671A
160	260	99 ohm	990A	1.1K	2.2K	733 ohm	731A
160	240	96 ohm	960A	1.2K	1.2K	600 ohm	601A
160	270	100 ohm	101D	1.5K	1.5K	750 ohm	751A
162	260	100 ohm	101B	1.5K	3.3K	1031 ohm	102A
180	300	113 ohm	111B	2K	2K	1000 ohm	102B
180	470	130 ohm	131C	2.2K	5.6K	1579 ohm	162A
180	390	123 ohm	121A	2.2K	4.4K	1467 ohm	152A
180	270	108 ohm	111A	2.2K	3.3K	1320 ohm	132A
180	220	99 ohm	101A	3K	6.2K	2022 ohm	202A
200	1.5K	176 ohm	171D	3K	2K	1200 ohm	122A
220	330	132 ohm	131A	3.3K	4.7K	1939 ohm	192A
220	270	121 ohm	121B	3.9K	3.3K	1788 ohm	182A
220	220	110 ohm	111D	4.7K	22K	3873 ohm	392A
240	170	100 ohm	101C	5K	5K	2500 ohm	252A
240	620	173 ohm	171C	6.8K	22K	5194 ohm	522A
250	250	125 ohm	131B	10K	51K	8361 ohm	842A
270	470	171 ohm	171A	50K	100K	33,333 ohm	333A

Power Derating Curve for Resistor Networks

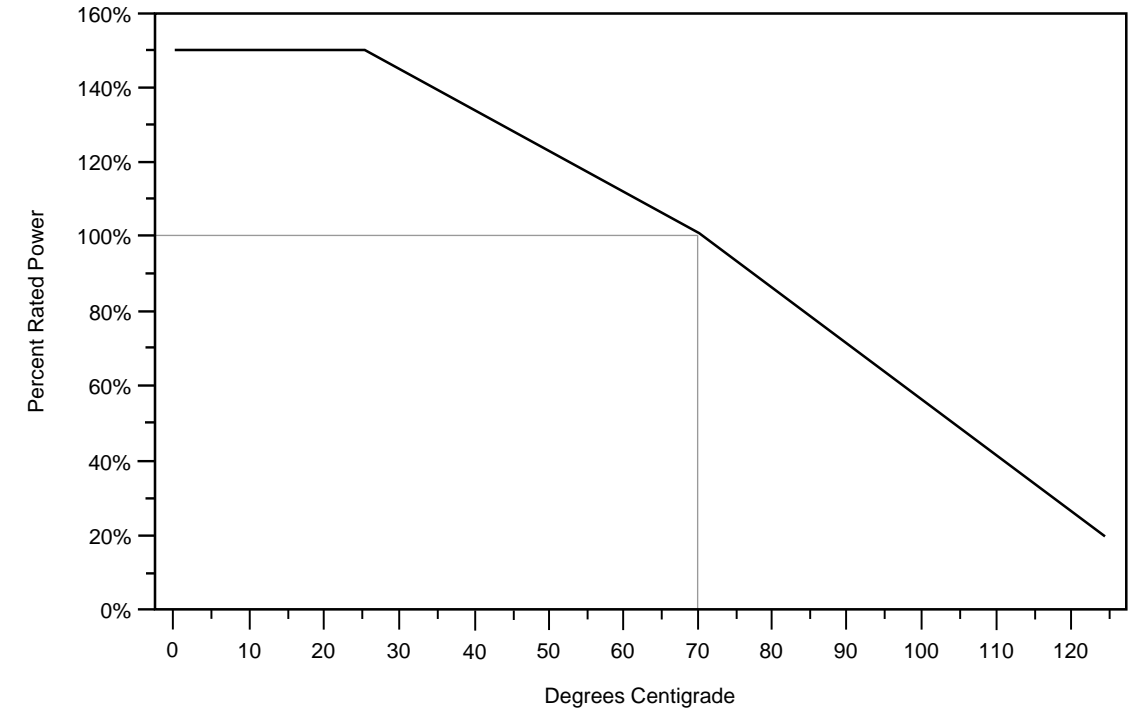

Part Marking

The following chart indicates the characters marked on parts with standard marking.

Part	Series	No. of Pins/Pads	Schematic	R	Resistor Value or Code	Tolerance	Date Code YRWK
742, 743, 744					✓		
745, 746			✓		✓		
752							
12 & 24 pad	✓	✓	✓		✓	✓	3-digit
10 & 20 pad		✓	✓		✓	✓	3-digit
9 & 18 pad			✓		✓	✓	3-digit
8 & 16 pad			✓		✓	✓	3-digit
753							
12 & 24 pad			✓		✓	✓	2-digit
10 & 20 pad			✓		✓	✓	2-digit
9 & 18 pad			✓		✓	✓	
8 & 16 pad			✓		✓	✓	
766, 767, 768	✓	✓	✓		✓	✓	4-digit
770	✓	✓	✓		✓		4-digit

Surface Mount Land Patterns

Concave and Convex Chip Resistor Arrays 742-746

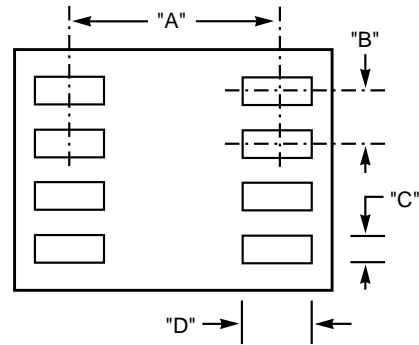

Concave/Convex

Series	Dimensions mm/inch			
	A	B	C	D
742	1.80 0.071	0.80 0.032	0.50 0.020	0.90 0.035
743	1.90 0.075	1.27 0.050	0.80 0.032	1.20 0.047
744	3.00 0.118	1.27 0.050	0.80 0.032	1.30 0.051
745	3.00 0.118	1.27 0.050	0.80 0.032	1.30 0.051
746	1.52 0.060	0.64 0.025	0.35 0.014	0.80 0.032

NOTE:

- Land Patterns for Concave and Convex termination can be the same.

Surface Mount Series 766, 767 & 768

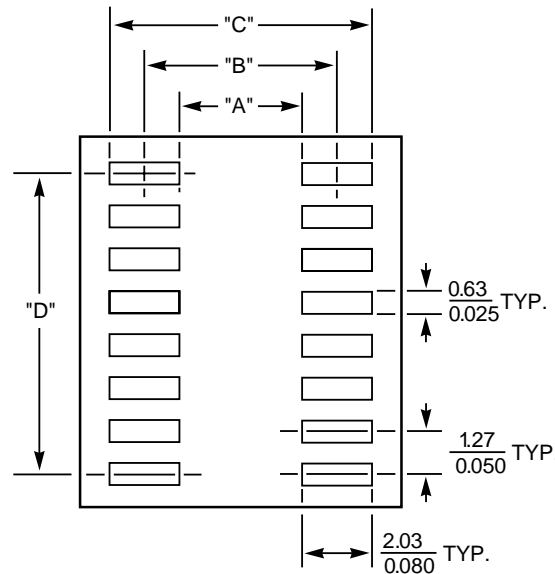

Lead Count	A	B	C	D
766-8P	3.60 0.140	5.60 0.220	7.60 0.300	3.81 0.150
766-14P	3.60 0.140	5.60 0.220	7.60 0.300	7.60 0.300
766-16P	3.60 0.140	5.60 0.220	7.60 0.300	8.90 0.350
767-14	5.34 0.210	7.37 0.290	9.40 0.370	7.60 0.300
767-16	5.34 0.210	7.37 0.290	9.40 0.370	8.90 0.350
768-14	5.34 0.210	7.37 0.290	9.40 0.370	7.60 0.300
768-16	5.34 0.210	7.37 0.290	9.40 0.370	8.90 0.350
768-20	5.34 0.210	7.37 0.290	9.40 0.370	11.43 0.450

Surface Mount Series 752

Stencil Opening

	DRT Solder Paste Stencil Opening			
	K	Sw	S	Q
4 mil 752	0.66 0.026	0.76 0.030	1.52 0.060	0.38 0.015
6 mil 752	0.051 0.020	0.064 0.025	1.40 0.055	0.30 0.012

Land Patterns

Dim.	In.	mm.
A	0.125	3.18
B	0.050	1.27
C	0.030	0.76
D	0.050	1.27
E	0.025	0.64
F	0.050	1.27

Stencil Opening

	SRT Solder Paste Stencil Opening			
	K	Sw	S	Q
4 mil 752	2.40 0.095	0.76 0.030	NA	0.38 0.015
6 mil 752	1.90 0.075	0.63 0.025	NA	0.33 0.013

No. of Pads	"H" Dim	
	In.	mm
8	0.350	8.89
9	0.400	10.16
10	0.450	11.43
12	0.550	13.97
16	0.350	8.89
18	0.400	10.16
20	0.450	11.43
24	0.550	13.97

Series 752 & 753 Land Patterns

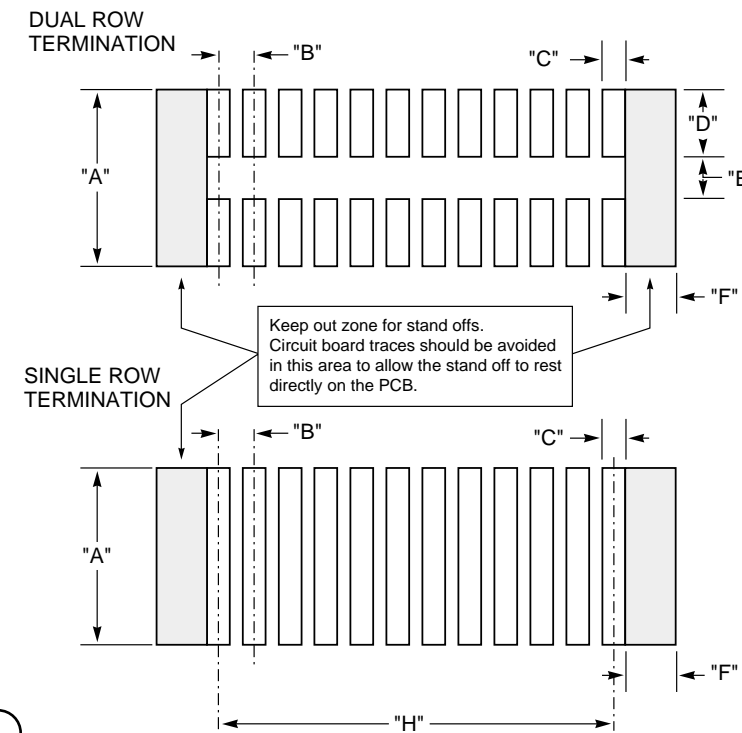

Surface Mount Series 753

Stencil Opening

	DRT Solder Paste Stencil Opening			
	K	Sw	S	Q
4 mil 753	0.51 0.020	0.30 0.012	1.32 0.052	0.15 0.006
6 mil 753	0.028 0.011	0.030 0.012	1.47 0.058	0.15 0.006

Land Patterns

Dim.	In.	mm.
A	0.120	3.05
B	0.025	0.64
C	0.017	0.43
D	0.050	1.27
E	0.020	0.51
F	0.035	0.89

Stencil Opening

	SRT Solder Paste Stencil Opening			
	K	Sw	S	Q
4 mil 753	2.75 0.108	0.30 0.012	NA	0.15 0.006
6 mil 753	1.72 0.068	0.30 0.012	NA	0.15 0.006

No. of Pads	"H" Dim	
	In.	mm
8	0.175	4.44
9	0.200	5.08
10	0.225	5.72
12	0.275	6.99
16	0.175	4.44
18	0.200	5.08
20	0.225	5.72
24	0.275	6.99

Series 752 & 753 Stencil Openings

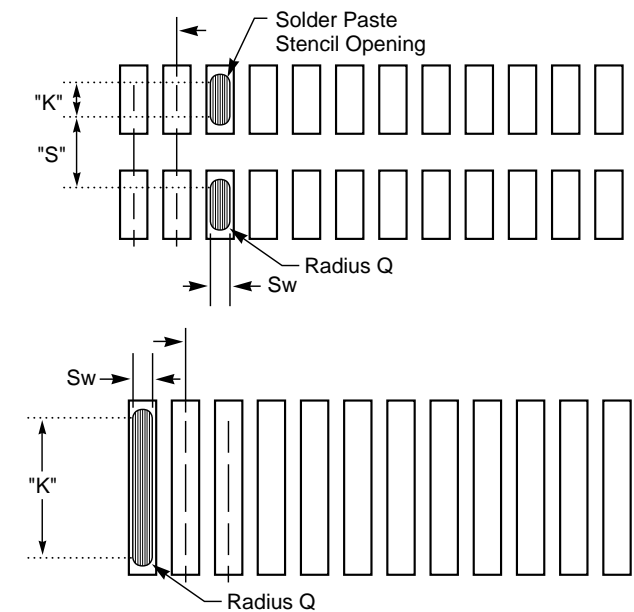

Standard Packaging

Series 752, 753, 766, 767, 768

Tape & Reel Specifications per EIA-481-2

Carrier Tape:	Resistivity <1 X105 ohm/sq.
Cover Tape:	Antistatic .004 max.
Reels:	Molded plastic
Cover Tape Pull:	30 To 130 gr.
Slide Pacs:	Antistatic

Bar Coding Available

Bar coding of reel and boxes available on request. CTS normally uses code configuration 39 in accordance with (AIM) USS 39 symbol specification. Outer container marketing per EIA-556.

Series 742, 743, 744, 745, 746

Tape & Reel	742C043	742C083 742X083	742C163	743C043	743C083	744C043	744C083	745C101 745C102	745X101 745X102	746X101
Parts/Reel	5000	5000	4000	4000	4000	4000	4000	4000	4000	5000
Pitch	4mm	4mm	4mm	4mm	4mm	4mm	8mm	4mm	4mm	4mm
Carrier Width	8mm	8mm	12mm	8mm	12mm	8mm	12mm	12mm	12mm	8mm
Material	paper	paper	plastic	plastic	plastic	plastic	plastic	plastic	plastic	paper
Reel diameter	7"	7"	7"	7"	7"	7"	7"	7"	7"	7"

Series 752

Tape & Reel	TR1	TR2
Parts/reel	5000 STD 1000 min.	2000 STD 1000 min.
Tape width	24mm	24mm
Tape pitch	4mm	12mm
Reel diameter	13"	13"

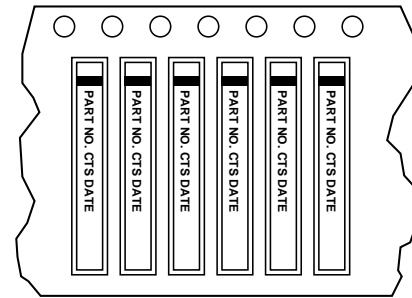

Bulk Pack 250 parts/bag

DIRECTION OF FEED →

Series 753

Tape & Reel	TR1	TR2
Parts/reel	5000 STD 1000 min.	2000 STD 1000 min.
Tape width	16mm	16mm
Tape pitch	4mm	8mm
Reel diameter	13"	13"

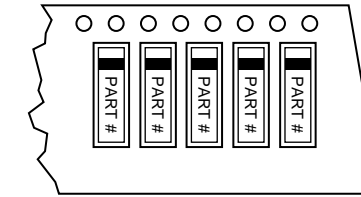

Bulk Pack 250 parts/bag

DIRECTION OF FEED →

Series 770

Bulk Pack All Products 250 Parts/Bag
Slide Pack Tube Length = 457mm/18 in

# Pins	4	5	6	7	8	9	10	11	12
Qty/Tube	50	40	32	28	24	22	19	18	16

Series 766/767/768

Network	8 Pin	14 Pin	16 Pin	14 Pin	16 Pin	20 Pin
Package	766	766	766	767/768	767/768	768
Tape & Reel						
Tape width	12mm	16mm	16mm	24mm	24mm	24mm
Tape pitch	8mm	8mm	8mm	12mm	12mm	12mm
Reel diameter	13"	13"	13"	13"	13"	13"
#parts/reel*	3,000	3,000	3,000	2,000	2,000	2,000
Reel diameter	7"	7"	7"			
#parts/reel*	800	800	800			
Slide Packs						
Tube length	20"	20"	20"	20"	20"	20"
#parts/slide pac*	99	56	49	48	43	35

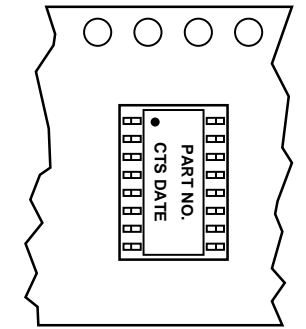

DIRECTION OF FEED →

*nominal full reels or slide packs

Environmental Performance Specifications

Test	Max. ΔR	Mil. Std. 202 Method	Test Cond.	Test Description
Thermal Cycling Series 752, 753, 766, 770 Series 767, 768 Series 742, 743, 744, 745, 746	0.5% 0.25% 1.0%	107	B	5 cycles, -65°C to +125°C 5 cycles, -55°C to +125°C
Short Time Overload Series 766, 770 Series 752, 753 Series 767, 768 Series 742, 745 Series 743 Series 744 Series 746	0.5% 0.5% 0.25% 2.0% 2.0% 2.0% 2.0%			2 1/2 x rated voltage, 5 sec (100V Max.) 2 1/2 x rated voltage, 5 sec (50V Max.) 2 1/2 x rated voltage, 5 sec. (100V Max.) 2 1/2 x rated voltage, 5 sec (100V Max.) 2 1/2 x rated voltage, 5 sec. (200V Max.) 2 1/2 x rated voltage, 5 sec (400V Max.) 2 1/2 x rated voltage, 5 sec (50V Max.)
Moisture Resistance Series 752, 753, 766, 767, 768, 770 Series 742, 743, 744, 745, 746	0.5% 2.0%	106		240 hours, 0.1 rated load, -10°C to +65°C, 90% RH
Load Humidity Series 752, 753, 766, 767, 768, 770	1.0%			1000 hours, 0.1 rated load, 70°C, 85-92% RH
High Temp Exposure Series 752, 753, 766, 767, 768, 770 Series 742, 743, 744, 745, 746	1.0% 1.0%			240 hours, no load, @ 125°C 1000 hours, no load, @ 125°C
Load Life Series 752, 753, 766, 767, 768 Series 770 Series 742, 743, 744, 745, 746	1.0% 1.0%	108	F D	2000 hours @ 70°C, rated load 1000 hours @70°C, rated load 1000 hours @ 70°C, rated load
Resistance to Solder Heat Series 752, 753, 766, 767, 768 Series 770 Series 742, 743, 744, 745, 746	0.25% 0.25% 1.0%		A B	30 seconds @ 218°C, dwell 3 second dwell @ 350°C solder 10 second dwell @ 260°C solder
Resistance to Leach Series 742, 743, 744, 745, 746, 752, 753	N/A			120 seconds @ 260°C solder
Mechanical Shock Series 752, 753, 766, 767, 768, 770	0.25%	213	I	100g, 1 msec., 3 shocks each plane
Vibration Series 752, 753, 766, 767, 768, 770		0.25%	204	D 20g, 10-2000Hz, 4 hours/plane

Test	Max. ΔR	Mil. Std. 202 Method	Test Cond.	Test Description
Terminal Strength Series 766, 767, 768 Series 770	0.25%			0.9 Kg. pull, 30 sec., two 45° bends 2.0 Kg. pull, 30 sec., three 45° bends
Low Temp Storage Series 752, 753, 766, 767, 768, 770	0.25%			24 hours @ -65°C, no load
Low Temp Operation Series 752, 753, 766, 767, 768, 770	0.25%			45 min @ -65°C, full load
Flammability (UL) Series 752, 753, 766, 767, 768, 770	N/A			94V-0
Non-Fungus per MIL-STD 810C				Series 752, 766, 767, 768, 770
Resistance to Solvents				Series All Isopropyl alcohol
Solderability				Series All RMA Flux, 230°C, 5 Seconds dip, 95% coverage