

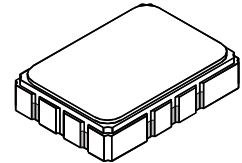

SF2038B

76.500 MHz SAW Filter



SMP-03

- **Designed for SDARS IF Receiver**
- **Low Insertion Loss**
- **5.0 X 7.0 mm Surface-Mount Case**
- **Differential or Single Ended Input and Output**
- **Complies with Directive 2002/95/EC (RoHS)** 

Absolute Maximum Ratings

Rating	Value	Units
Maximum Incident Power in Passband	+10	dBm
Max. DC voltage between any 2 terminals	30	VDC
Storage Temperature Range	-40 to +85	°C
Max Soldering Profile	265°C for 10 s	

Characteristic	Sym	Notes	Min	Typ	Max	Units
Nominal Center Frequency	f_c	1	76.500			MHz
Passband Insertion Loss	IL			10.0	12.0	dB
1dB Passband	BW_1	1	12.5	14.0		MHz
15dB Bandwidth	BW_{15}			16.8	18.0	MHz
30dB Bandwidth	BW_{30}			18.0	19.2	MHz
Amplitude Ripple over $f_c \pm 6.25$ MHz				0.70	1.3	dB _{P-P}
Group Delay Variation over $f_c \pm 6.25$ MHz	GDV			40	150	ns _{P-P}
Rejection	50 to 64.44 MHz	1, 3	40	46		dB
	64.44 to 66.70 MHz		36	41		
	86.30 to 87.06 MHz		*30	44		
	87.06 to 91.50 MHz		36	44		
	91.50 to 100 MHz		40	47		
Operating Temperature Range	T_A	1	-40		+85	°C
Frequency Coefficient	FTC			-87		ppm/°C
Differential Input	175 ohms					
Differential Output	180 ohms					
Case Style	SMP-03 7 x 5 mm Nominal Footprint					
Lid Symbolization (YY=year, WW=week, S=shift) See note 4	RFM SF2038B YYWWS					

*At low temperature extreme -40°C

Electrical Connections

Connection	Terminals
Port 1 Hot	10
Port 1 Ground Return	1
Port 2 Hot	5
Port 2 Ground Return	6
Case Ground	All Others

NOTES:

1. Unless noted otherwise, all specifications apply over the operating temperature range with filter soldered to the specified demonstration board with impedance matching to 50 Ω and measured with 50 Ω network analyzer.
2. Unless noted otherwise, all frequency specifications are referenced to the nominal center frequency, fc.
3. Rejection is measured as attenuation below the minimum IL point in the passband. Rejection in final user application is dependent on PCB layout and external impedance matching design. See Application Note No. 42 for details.
4. "LRIP" or "L" after the part number indicates "low rate initial production" and "ENG" or "E" indicates "engineering prototypes."
5. The design, manufacturing process, and specifications of this filter are subject to change.
6. Tape and Reel Standard ANSI / EIA 481.
7. Either Port 1 or Port 2 may be used for either input or output in the design. However, impedances and impedance matching may vary between Port 1 and Port 2, so that the filter must always be installed in one direction per the circuit design.
8. US and international patents may apply.
9. Murata, stylized Murata logo, and Murata N.A., Inc. are registered trademarks of Murata Manufacturing Co., Ltd.
10. Electrostatic Sensitive Device. Observe precautions for handling.



Matching Circuit and Matching Component Values Used in G3 Sirius Radios

(Refer to Sirius Radio G3 Chipset Application Note, Doc. #RX000104-B, Sec. 4.2.2)

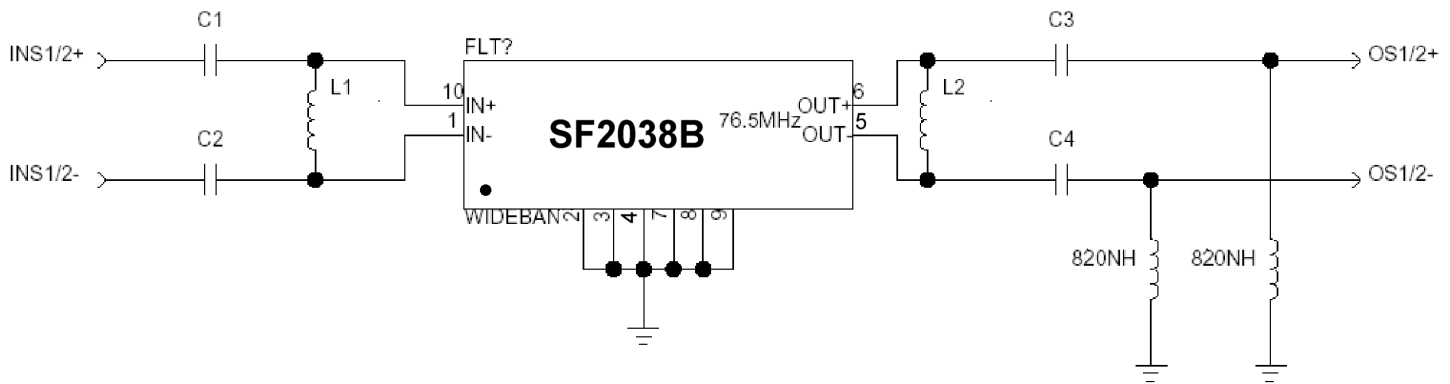

Wideband SAW Matching Circuit

Wideband SAW Matching Values

Reference Designator	Value
C1	15 pF
C2	15 pF
L1	270 nH
L2	270 nH
C3	27 pF
C4	27 pF

Matching Circuit and Matching Component Values Used on Filter Demo Board

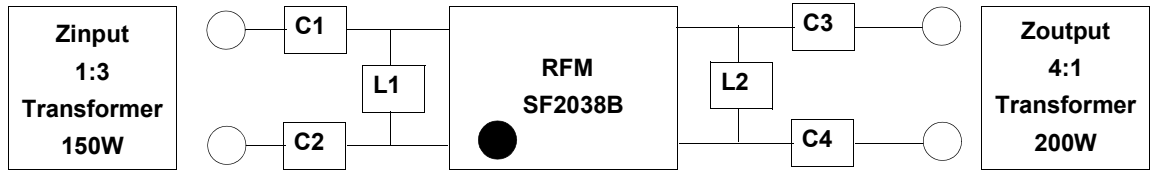

SF2038B
76.500 MHz

C1 = 22pF
C2 = 22pF
L1 = 220nH
L2 = 270nH
C3 = 22pF
C4 = 22pF

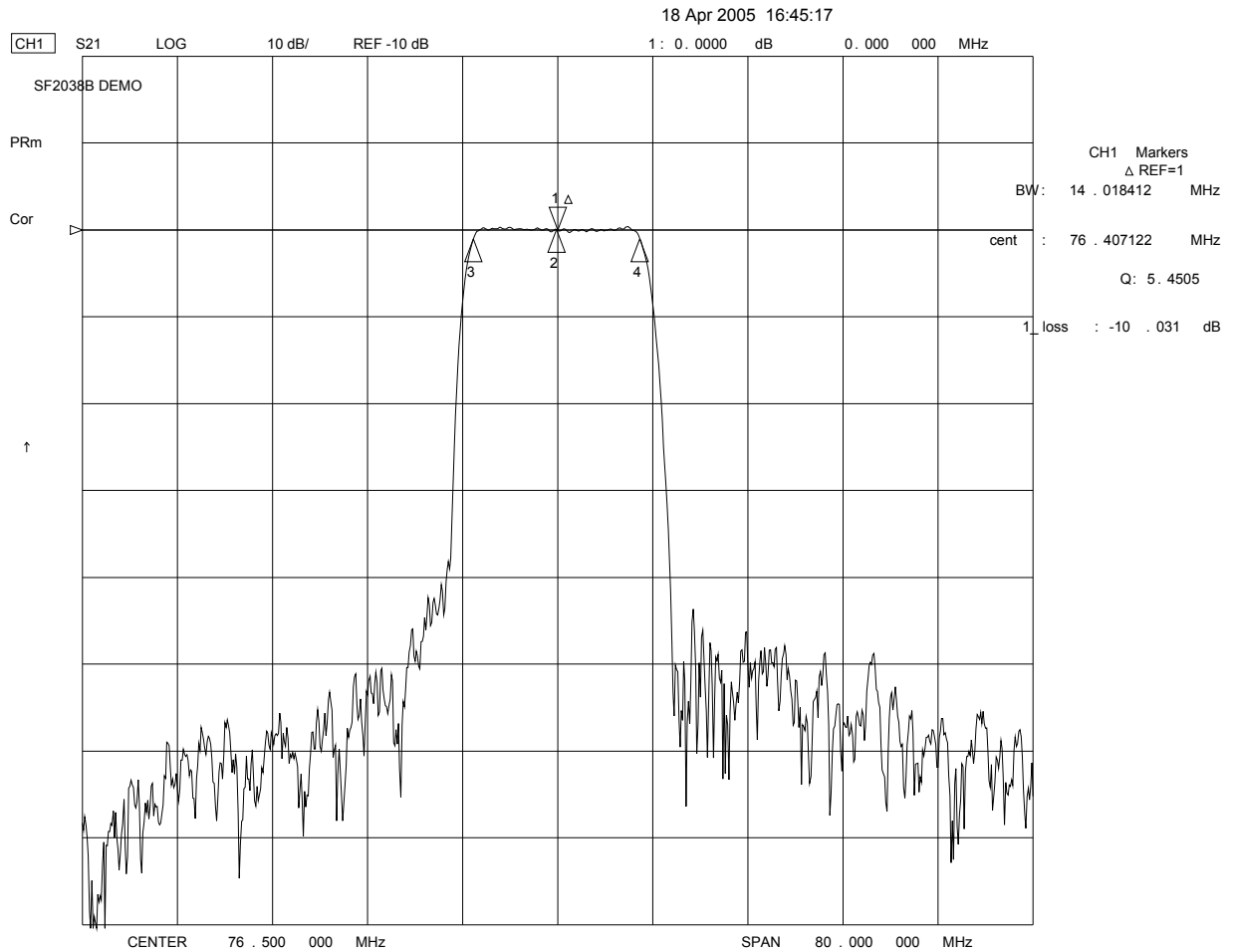

18 Apr 2005 16:42:05

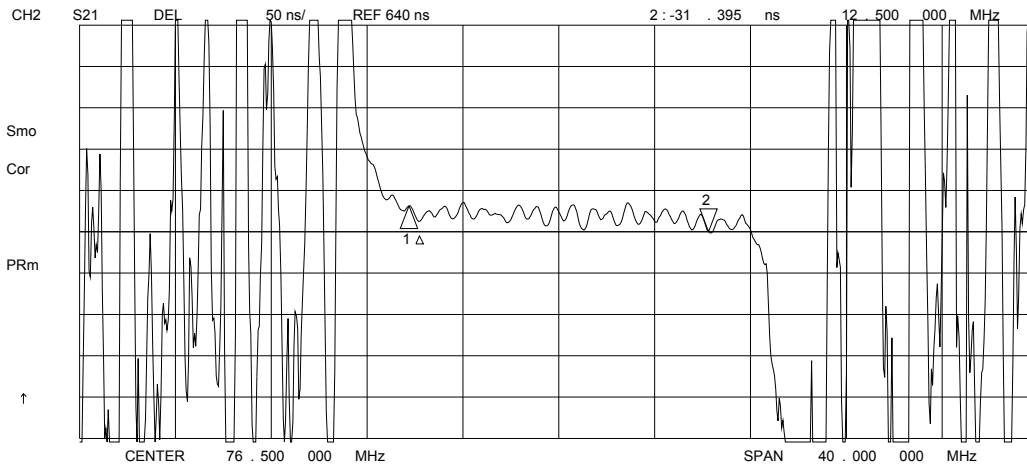
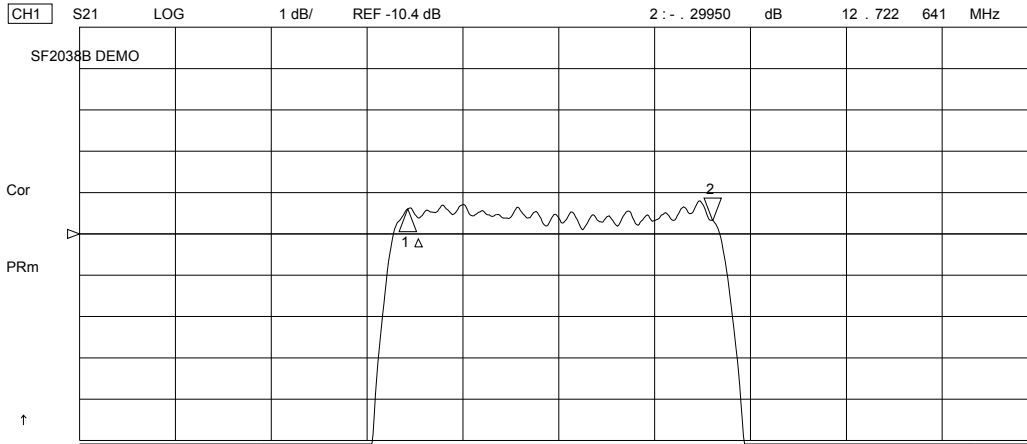

18 Apr 2005 16:35:10

CH1 S11 1 UFS

1: 44.537 Ω 19.910 Ω 41.422 nH 76.500 000 MHz

SF2038B DEMO

Cor

PRm

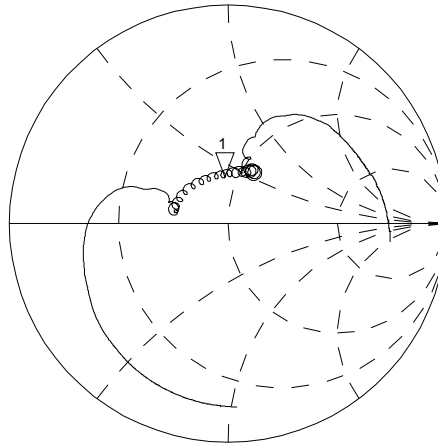

CH2 S22 1 UFS

1: 53.521 Ω 19.055 Ω 39.642 nH 76.500 000 MHz

Cor

PRm

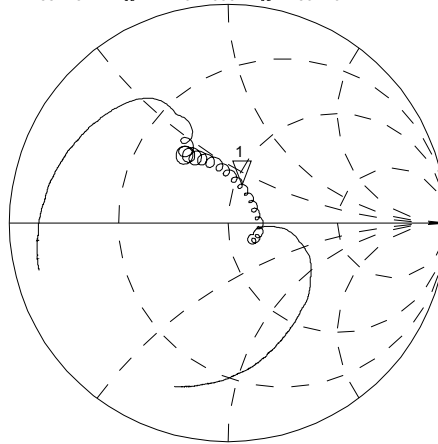

CENTER 76.500 000 MHz

SPAN 40.000 000 MHz

SMP-03 Case

10-Terminal Ceramic Surface-Mount Case

7 x 5 mm Nominal Footprint

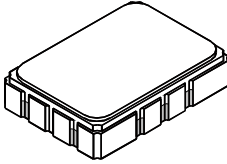

Recommended PCB Footprint

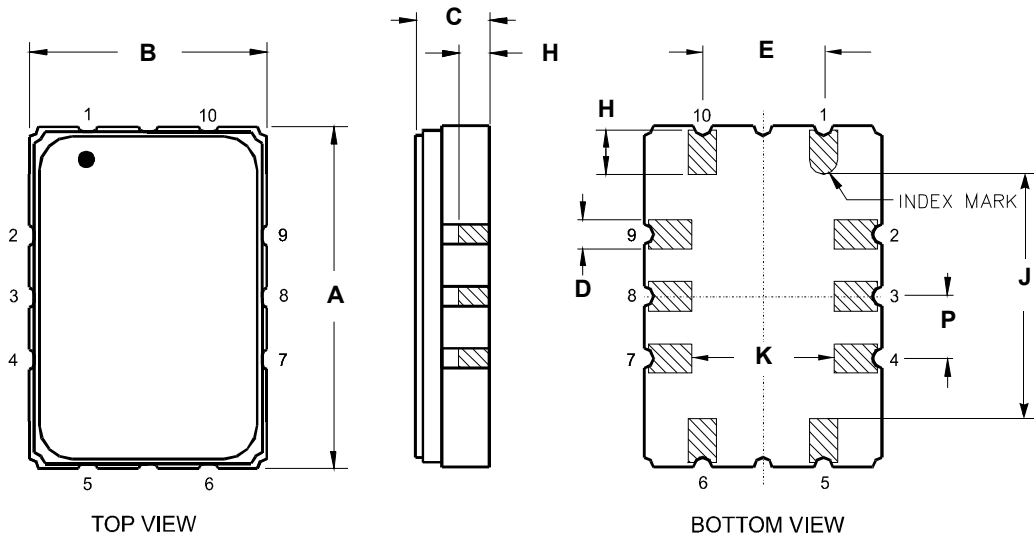
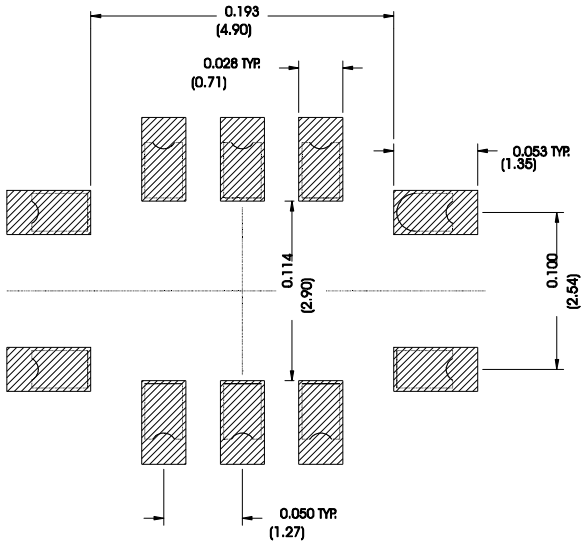

Case Dimensions						
Dimension	mm			Inches		
	Min	Nom	Max	Min	Nom	Max
A	6.80	7.00	7.20	0.268	0.276	0.283
B	4.80	5.00	5.20	0.189	0.197	0.205
C		1.65	2.00		0.065	0.079
D	.47	0.60	.73	0.019	0.024	0.029
E	2.41	2.54	2.67	0.095	0.100	0.105
H	0.87	1.0	1.13	0.034	0.039	0.044
J	4.87	5.00	5.13	0.192	0.197	0.202
K	2.87	3.00	3.13	0.113	0.118	0.123
P	1.14	1.27	1.40	0.045	0.050	0.055

Materials	
Solder Pad Termination	Au plating 30 - 60 ulnches (76.2-152 uM) over 80-200 ulnches (203-508 uM) Ni.
Lid	Fe-Ni-Co Alloy Electroless Nickel Plate (8-11% Phosphorus) 100-200 ulnches Thick
Body	Al ₂ O ₃ Ceramic
Pb Free	

Electrical Connections		
	Connection	Terminals
Port 1	Input or Return	10
	Return or Input	1
Port 2	Output or Return	5
	Return or Output	6
	Ground	All others
Single Ended Operation		Return is ground
Differential Operation		Return is hot

Tape and Reel Specifications

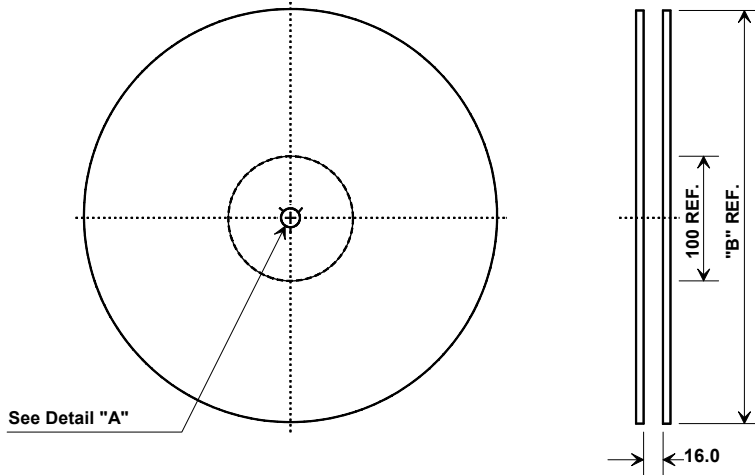

"B "		Quantity Per Reel
Nominal Size		
Inches	millimeters	
7	178	500
13	330	2000

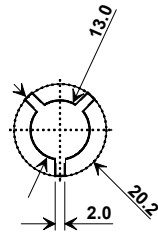

COMPONENT ORIENTATION and DIMENSIONS

Carrier Tape Dimensions	
Ao	5.5 mm
Bo	7.5 mm
Ko	2.0 mm
Pitch	8.0 mm
W	16.0 mm

