

NOTES:

1. Material : Music Wire
2. Finish : Glod Irridite
3. Ends : Closed and Ground
4. Total Coils : 5.750
5. Sugg. Max. Deflection : 0.970 (in)
6. Sugg. Max. Load : 21.000 (lbs)
7. All Drawing Dimensions are in Inches [mm]

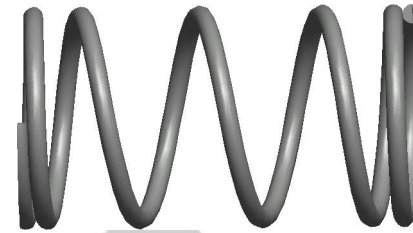

\varnothing 0.072
 [1,83]
 WIRE DIA

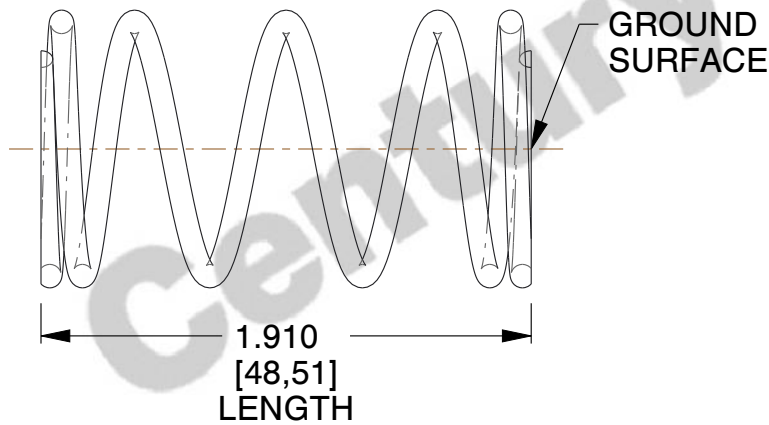

\varnothing 0.850
 [21,59]
 O.D

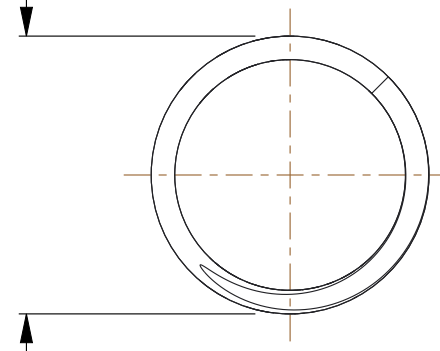

COMPONENT		SPRINGS	
72189		UNIT	
		INCH [mm]	
		SHEET	
COMPRESSION SPRINGS		1 of 1	